

HAWORTH

# Seating

North America Price List – February 2024



# Electronic Update Page – Seating Price List

- The table below lists all of the updates and addendums added to this price list since the original version was created.
- All **Update** pages will replace the existing pages within the document.
- All **New** pages will be placed at the back of the document.

Link	Date	Pages	Description
<a href="#">Click Here</a>	March 2024	1A	New – Bowi Conference Chair price page added.
<a href="#">Click Here</a>	March 2024	2A	New – New Soji XL Task Chair price page added.



**This Haworth North American price book contains US list prices.**  
Canadian customers can convert the US list price into their Canadian equivalent by going to [www.Haworth.com/Canada](http://www.Haworth.com/Canada) to find the current Canadian multipliers. These multiplier factors allow you to convert the US list price into a Canadian list price.

# Price List Overview

The following overview explains how information is organized within the Seating price list (Includes: Fern®, Zody®, Very®, Soji®, Improv®, X99®, Maari®, Candor®, Composites™, Forenze™, Riverbend™, Pebble®, Openest™, Pip™, Poppy™, HarborWork Lounge®, Hello®, ToDo® and Tilt™).

- 1 Front Cover**
  - Includes the price book title and pricing effectivity date.
- 2 Canadian Conversion / Update Page**
  - Pricing conversion information for converting US pricing into the equivalent Canadian pricing is located on the footer of this page.
  - All Price Book updates will be listed on this page including the date, page number and description of the update.
- 3 Price List Table of Contents**
  - Price List table of contents with page numbers.
- 4 Statement of Line**
  - Provides a pictorial outline of the entire product offering.
- 5 Price List**

Each price list page contains the following:

  - Product Illustration
  - Catalog Number
  - To Order Specify – sequencing for ordering product options and finishes
  - List Prices
  - Product Specification Dimensions
  - Features
  - Specification Tips
  - Class, Discount Group Number (used for discounting) and GSA information
- 6 Finishes, Fabrics and COM**
  - Lists information for material finishes and availability.
  - Provides COM information and requirements (if applicable).
- 7 Index**
  - Products are listed alphabetically by alpha-numeric catalog numbers with price list page number.
- 8 Product Non-Obsolescence, Warranty Policy and Terms of Sale**
  - Provides information about the Haworth policy for non-obsolescence, warranty and Terms of Sale.

## Additional Information and Resources

Prices are subject to change without notice or approval. Haworth dealers should always submit proposals through Lynx before presenting to customers. See North American Terms of Sale for more information.

### Online Resources

- haworth.com**
  - Haworth's corporate website provides access to price books and a variety of other resources and publications.
- surfaces.haworth.com**
  - Website provides access to the most current fabrics and finishes offered across Haworth's various product lines.

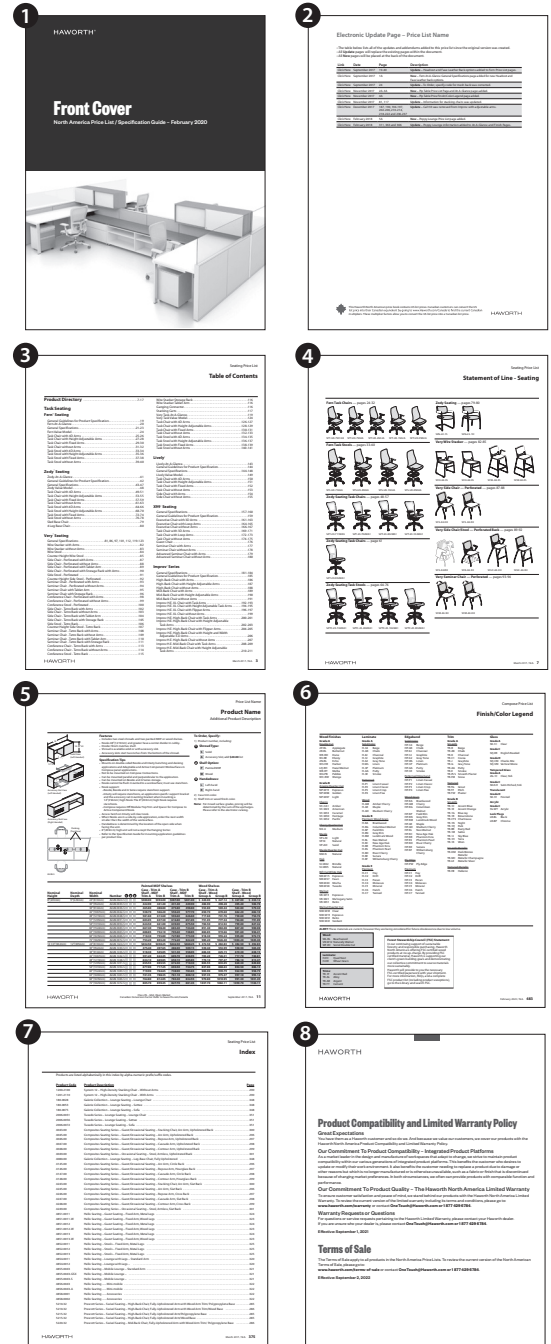

# Table of Contents

## Statement of Line ..... 6-15

## Task Seating

### Fern® Seating

General Guidelines for Product Specification	17
Fern At-A-Glance — General Specifications	18
General Specifications	19-21
Task Chair with 4D Arms — Plastic Base Model	23
Task Chair with 4D Arms — Aluminum Base Model	24
Task Chair with Height Adjustable Arms — Plastic Base Model	25
Task Chair with Height Adjustable Arms — Aluminum Base Model	26
Task Chair with Fixed Arms — Plastic Base Model	27
Task Chair with Fixed Arms — Aluminum Base Model	28
Task Chair without Arms — Plastic Base Model	29
Task Chair without Arms — Aluminum Base Model	30
Task Stool with 4D Arms — Plastic Base Model	31
Task Stool with 4D Arms — Aluminum Base Model	32
Task Stool with Height Adjustable Arms — Plastic Base Model	33
Task Stool with Height Adjustable Arms — Aluminum Base Model	34
Task Stool with Fixed Arms — Plastic Base Model	35
Task Stool with Fixed Arms — Aluminum Base Model	36
Task Stool without Arms — Plastic Base Model	37
Task Stool without Arms — Aluminum Base Model	38

### Zody® Seating

Zody II-At-A-Glance	39
General Specifications for Product Specification	40-41
General Specifications	42-45
Task Chair	46-48
Stool	49-50
Dual Posture	51-52
Zody LX At-A-Glance	53
General Specifications for Product Specification	54-55
General Specifications	56-58
Task Chair	59-60
Stool	61-62
Dual Posture	63-64
Zody-At-A-Glance	65
General Specifications for Product Specification	66-67
General Specifications	68-71
Task Chair with 4D Arms	73-75
Task Chair with Height Adjustable Arms	77-79
Task Chair with Fixed Arms	81-83
Task Chair without Arms	85-87
Task Stool with 4D Arms	89-91
Task Stool with Height Adjustable Arms	93-95
Task Stool with Fixed Arms	97-99
Task Stool without Arms	101-103
Sled Base	104
4 Leg	105

### Very® Seating

Very-Task-At-A Glance	107
General Specifications	108-112
Task Chair with 4D Arms	114-115
Task Chair with Height Adjustable Arms	116-117
Task Chair with Fixed Arms	118-119
Task Chair without Arms	120-121
Task Stool with 4D Arms	122-123
Task Stool with Height Adjustable Arms	124-125
Task Stool with Fixed Arms	126-127
Task Stool without Arms	128-129
General Specifications	131
Wire Stacker with Arms	132
Wire Stacker without Arms	133

Bar Height Wire Stool	134
Counter Height Wire Stool	135
General Specifications	136
Side Chair - Perforated Back with Arms	137
Side Chair - Perforated Back without Arms	138
Side Chair - Perforated Back with Tablet Arm	139
Side Chair - Perforated Back with Storage Rack	140
Bar Height Side Stool - Perforated Back	141
Counter Height Side Stool - Perforated Back	142
Seminar Chair - Perforated Back with Arms	143
Seminar Chair - Perforated Back without Arms	144
Seminar Chair - Perforated Back with Storage Rack	145
General Specifications	147
Conference Chair - Perforated Back with Arms	148
Conference Chair - Perforated Back without Arms	149
Conference Stool - Perforated Back	150
Ganging Connector	151
Stacking Carts	151

### Soji® Seating

General Guidelines for Product Specification	153
Soji At-A-Glance — General Specifications	154
General Specifications	155-158
Task Chair with 4D Arms — Plastic Base	159
Task Chair with 4D Arms — Aluminum Base	160
Task Chair with Height Adjustable Arms — Plastic Base	161
Task Chair with Height Adjustable Arms — Aluminum Base	162
Task Chair with Fixed Arms — Plastic Base	163
Task Chair with Fixed Arms — Aluminum Base	164
Task Chair without Arms — Plastic Base	165
Task Chair without Arms — Aluminum Base	166
Task Stool with 4D Arms — Plastic Base	167
Task Stool with 4D Arms — Aluminum Base	168
Task Stool with Height Adjustable Arms — Plastic Base	169
Task Stool with Height Adjustable Arms — Aluminum Base	170
Task Stool with Fixed Arms — Plastic Base	171
Task Stool with Fixed Arms — Aluminum Base	172
Task Stool without Arms — Plastic Base	173
Task Stool without Arms — Aluminum Base	174

### Veda® Seating

General Specifications for Product Specification	175
Veda At-A-Glance — General Specifications	176
Mid-Back Chair — Standard Tilt	177
Mid-Back Chair — Synchronized Tilt	177
High-Back Chair — Synchronized Tilt	178

### Improv® Series

General Specifications	179-182
General Guidelines for Product Specification	183
Improv H.E. XL Chair with Task Arms	184
Improv H.E. XL Chair with Flipper Arms	185
Improv H.E. XL Chair without Arms	186
Improv H.E. High-Back Chair with Task Arms	187
Improv H.E. High-Back Chair with Flipper Arms	188
Improv H.E. High-Back Chair with Height and Width Adjustable 3-D Arms	189
Improv H.E. High-Back Chair without Arms	190
Improv H.E. Mid-Back Chair with Task Arms	191
Improv H.E. Mid-Back Chair with Flipper Arms	192
Improv H.E. Mid-Back Chair with Height and Width Adjustable 3-D Arms	193
Improv H.E. Mid-Back Chair without Arms	194
Improv H.E. Stool with Task Arms	195
Improv H.E. Stool with Flipper Arms	196
Improv H.E. Stool with Height and Width Adjustable 3-D Arms	197
Improv H.E. Stool without Arms	198
Leg-Base Stacking Chair with Arms	199
Leg-Base Stacking Chair without Arms	200

# Table of Contents

Sled-Base Chair with Arms, Non-Stacking .....	201	<b>Riverbend Accessories</b>	
Sled-Base Chair without Arms, Non-Stacking .....	202	Ganging Bracket .....	251
Stool with Arms .....	203	<b>Riverbend Power Module</b>	
Stool without Arms .....	203	Corded .....	252
Stacking Dolly .....	204	Hardwire .....	252
Chair-to-Chair Connecting Bars .....	204	<b>Openest™ Collection</b>	
Tandem Seating Specifications .....	205	Plume 3 .....	253
Tandem Seating Dimensions .....	205	Plume 6 .....	253
<b>X99® Seating</b>		Plume 9 .....	253
General Specifications .....	207	Feather – Symmetrical .....	254
General Guidelines for Product Specification .....	208	Feather – Asymmetrical .....	254
Guest Chair .....	209	Chick Pouf with Back .....	255
Seminar Chair with Arms .....	210	Chick Pouf without Back .....	255
Seminar Chair without Arms .....	211	Large Square – No Back .....	256
Advanced Seminar Chair with Arms .....	212	Rectangle – No Back .....	256
Advanced Seminar Chair without Arms .....	213	Round – No Back .....	257
<b>Maari Seating</b>		Sprig Table – Rectangle .....	258
General Specifications .....	215-216	Sprig Table – Round .....	258
Sled Base Chair With Arms .....	217	<b>Pip™</b>	
Sled Base Chair Without Arms .....	218	Personal Laptop Table .....	259
Four-Leg Chair With Arms .....	219	<b>Poppy™</b>	
Four-Leg Chair Without Arms .....	220	Poppy-At-A-Glance .....	261
Wood-Leg Chair Without Arms .....	221	Four Star Base with Glides .....	262
Four-Star Base Chair With Arms .....	222	Five Star Base with Casters .....	262
Four-Star Base Chair Without Arms .....	223	Sled Base .....	263
Five-Star Base Chair With Arms .....	224	Wood Base .....	263
Five-Star Base Chair Without Arms .....	225	Basket .....	264
Sled Base Stool Standard Back .....	226	Swivel .....	264
Sled Base Stool Low Back .....	227	<b>Harbor Work Lounge®</b>	
Four-Leg Stool With Arms .....	228	Harbor Work Lounge At-A-Glance .....	265
Four-Leg Stool Without Arms .....	229	Fully Upholstered, Cast Aluminum Base Lounge Chair .....	266
Wood-Leg Stool Standard Back .....	230	Fully Upholstered, Cast Aluminum Base Ottoman .....	267
Wood-Leg Stool Low Back .....	231	Partially Upholstered, Cast Aluminum Base Lounge Chair .....	268
<b>Wood Side Seating</b>		Partially Upholstered, Cast Aluminum Base Ottoman .....	269
General Specifications .....	233	<b>Hello® Seating</b>	
General Guidelines for Product Specification .....	233	Lounge with Legs, Standard Arm .....	270
<b>Candor® Seating</b>		<b>ToDo®</b>	
Modern Fully Upholstered Seat and Back .....	234	General Specifications .....	271-272
Modern Fully Upholstered Seat and 1/2 Back .....	234	Single, Stationary .....	273
<b>Composites™ Seating Series</b>		Single, Mobile .....	274
Arc Arm, Upholstered Back .....	235	<b>Tilt</b>	
Stool, Armless, Upholstered Back .....	235	Tilt Stool .....	275
<b>Lounge Seating</b>		<b>Finishes and Fabrics</b>	
<b>Riverbend™ and Pebble®</b>		Finish/Color Legends .....	276-279
Riverbend and Pebble -At-A-Glance .....	237-242	Fabric Pattern Usage Matrix .....	280
<b>Riverbend™</b>		Haworth Fabrics/Color Legend .....	281
Single Seat – Straight .....	243	COM Information .....	282
Double Seat – Straight .....	244	<b>Index</b> .....	283-288
Triple Seat – Straight .....	245	<b>Product Warranty</b> .....	Inside Back Cover
90° Curved – Concave .....	246		
60° Curved – Concave .....	247		
60° Curved – Convex .....	248		
Corner – Square .....	249		
<b>Pebble®</b>			
Ottoman .....	250		

# Statement of Line

## Fern Task Chair — pages 23-30



SFT-U0-7S01A  
4D Arms  
Plastic Base



SFT-U0-7S01A  
4D Arms  
Aluminum Base



SFT-U0-4S01A  
Height  
Adjustable Arms  
Plastic Base



SFT-U0-4S01A  
Height  
Adjustable Arms  
Aluminum Base



SFT-U0-1S01A  
Fixed Arms  
Plastic Base



SFT-U0-1S01A  
Fixed Arms  
Aluminum Base



SFT-U0-0N01A  
Without Arms  
Plastic Base



SFT-U0-0N01A  
Without Arms  
Aluminum Base

## Fern Task Stool — pages 31-38



SFS-U0-7S01A  
4D Arms  
Plastic Base



SFS-U0-7S01A  
4D Arms  
Aluminum Base



SFS-U0-4S01A  
Height  
Adjustable Arms  
Plastic Base



SFS-U0-4S01A  
Height  
Adjustable Arms  
Aluminum Base



SFS-U0-1S01A  
Fixed Arms  
Plastic Base



SFS-U0-1S01A  
Fixed Arms  
Aluminum Base



SFS-U0-0N01A  
Without Arms  
Plastic Base



SFS-U0-0N01A  
Without Arms  
Aluminum Base

## Zody II Task Chair — pages 46-48



S2TC-20-0  
No Arms



S2TC-20-1  
Fixed Arms



S2TC-20-4  
Height  
Adjustable Arms



S2TC-20-7  
4D Arms

## Zody II Stool — pages 49-50



S2TS-20-0  
No Arms



S2TS-20-1  
Fixed Arms



S2TS-20-4  
Height  
Adjustable Arms



S2TS-20-7  
4D Arms

## Zody II Dual Posture Chair — pages 51-52



S2TD-20-1  
Fixed Arms



S2TD-20-4  
Height  
Adjustable Arms



S2TD-20-7  
4D Arms

## Zody LX Task Chair — pages 59-60



S2UC-22-0  
No Arms



S2UC-22-1  
Fixed Arms



S2UC-22-4  
Height  
Adjustable Arms



S2UC-22-7  
4D Arms

## Zody LX Stool — pages 61-62



S2US-22-0  
No Arms



S2US-22-1  
Fixed Arms



S2US-22-4  
Height  
Adjustable Arms



S2US-22-7  
4D Arms

# Statement of Line

## Zody LX Dual Posture Chair — pages 63-64



S2UD-22-1  
Fixed Arms



S2UD-22-4  
Height  
Adjustable Arms



S2UD-22-7  
4D Arms

## Zody Task Chair/Stool — pages 73-103



SZT-20-702MA1  
4D Arms



SZT-20-402MA1  
Height  
Adjustable Arms



SZT-20-102MA1  
Fixed Arms



SZT-20-002MA1  
Without Arms



SZTC-20-702MA1  
4D Arms



SZTC-20-402MA1  
Height  
Adjustable Arms



SZTC-20-102MA1  
Fixed Arms



SZTC-20-002MA1  
Without Arms

## Zody Guest — pages 104-105



SZG-22-1  
Sled Base



SZG-22-1  
4 Leg

## Very Task Chair/Stool — pages 114-129



SCT-20-7011  
4D Arms



SCT-20-4011  
Height  
Adjustable Arms



SCT-20-1011  
Fixed Arms



SCT-20-0011  
Without Arms



SCTC-20-7011  
4D Arms



SCTC-20-4011  
Height  
Adjustable Arms



SCTC-20-1011  
Fixed Arms



SCTC-20-0011  
Without Arms

## Very Wire Stacker Chair/Stool — pages 132-135



SCH-44-3S  
With Arms



SCH-44-0S  
Without Arms



SCW-44-3S  
Bar Height  
With Arms



SCW-44-0S  
Bar Height  
Without Arms



SCWC-44-3S  
Counter Height  
With Arms



SCWC-44-0S  
Counter Height  
Without Arms

# Statement of Line

## Very Side Chair/Stool — Perforated Back — pages 137-142



SCS-44-3H  
With Arms



SCS-44-0H  
Without Arms



SCS-44-RH  
With Tablet Arm



SCK-44-3H  
With Storage  
Rack



SCL-44-3H  
Bar Height  
With Arms



SCL-44-0H  
Bar Height  
Without Arms



SCLC-44-3H  
Counter Height  
With Arms



SCLC-44-0H  
Counter Height  
Without Arms

## Very Seminar Chair — Perforated Back — pages 143-146



SCM-44-3H  
With Arms



SCM-44-0H  
Without Arms



SCB-44-3H  
With Arms  
With Storage Rack



SCB-44-0H  
Without Arms  
With Storage Rack

## Very Conference Chair/Stool — Perforated Back — pages 148-150



SCC-44-11  
With Arms



SCC-44-01  
Without Arms



SCF-44-11  
With Arms



SCF-44-01  
Without Arms

## Very Accessories — pages 151-152



SCSG-1  
SCSG-2  
Ganging  
Connector



SCT-1  
Stacking Carts



SCT-3  
SCT-4  
Stacking Carts

## Soji Task Chair — pages 159-166



SJT-20-711A  
4D Arms  
Plastic Base



SJT-20-711A  
4D Arms  
Aluminum Base



SJT-20-401X  
Height  
Adjustable Arms  
Plastic Base



SJT-20-411X  
Height  
Adjustable Arms  
Aluminum Base



SJT-20-111A  
Fixed Arms  
Plastic Base



SJT-20-111A  
Fixed Arms  
Aluminum Base



SJT-20-011A  
Without Arms  
Plastic Base



SJT-20-011A  
Without Arms  
Aluminum Base



# Statement of Line

## Soji Task Stool — pages 167-174



SJTC-701X  
SJTC-701A  
**4D Arms**  
**Plastic Base**



SJTC-701X  
SJTC-701A  
**4D Arms**  
**Aluminum Base**



SJTC-401X  
SJTC-401A  
**Height Adjustable Arms**  
**Plastic Base**



SJTC-401X  
SJTC-401A  
**Height Adjustable Arms**  
**Aluminum Base**



SJTC-101X  
SJTC-101A  
**Fixed Arms**  
**Plastic Base**



SJTC-101X  
SJTC-101A  
**Fixed Arms**  
**Aluminum Base**



SJTC-001X  
SJTC-001A  
**Without Arms**  
**Plastic Base**



SJTC-001X  
SJTC-001A  
**Without Arms**  
**Aluminum Base**

## Veda Chairs — pages 177-178



SE3T  
**Mid-Back**  
**Standard Tilt**



SE3S  
**Mid-Back**  
**Synchronized Tilt**



SESS  
**High-Back**  
**Synchronized Tilt**

## Improv Series H.E. XL Chairs — pages 184-186



M271-1442  
**Task Arms**



M271-1H42  
**Flipper Arms**



M271-1042  
**Without Arms**

## Improv Series H.E. High-Back Chairs — pages 187-190



M251-1442  
**Task Arms**



M251-1H42  
**Flipper Arms**



M251-1W42  
**Height and Width Adjustable 3-D Arms**



M251-1042  
**Without Arms**

## Improv Series H.E. Mid-Back Chairs — pages 191-194



M231-1442  
**Task Arms**



M231-1H42  
**Flipper Arms**



M231-1W42  
**Height and Width Adjustable 3-D Arms**



M231-1042  
**Without Arms**

# Statement of Line

## Improv Series H.E. Stools — pages 195-198



M2E1-1442  
Task Arms



M2E1-1H42  
Flipper Arms



M2E1-1W42  
Height and Width  
Adjustable 3-D Arms



M2E1-1042  
Without Arms

## Improv Series Leg-Base Stacking Chairs — pages 199-200



M600-2110  
With Arms



M600-2310  
With Arms  
Wood Back



M600-2100  
Without Arms



M600-2300  
Without Arms  
Wood Back

## Improv Series Sled-Base Non-Stacking Chairs — pages 201-202

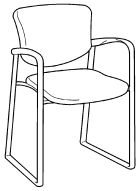

M601-2110  
With Arms



M601-2310  
With Arms  
Wood Back

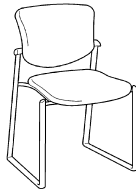

M601-2100  
Without Arms



M601-2300  
Without Arms  
Wood Back

## Improv Series Stools — page 203



M600-8110  
With Arms



M600-8310  
With Arms  
Wood Back



M600-8100  
Without Arms



M600-8300  
Without Arms  
Wood Back

## Improv Series Accessories — page 204

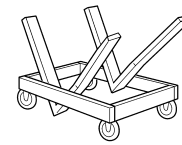

MPRV-CART  
Stacking Dolly

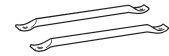

MPRV-BARS  
Chair-to-Chair  
Connecting Bars

## X99 Guest & Seminar Chairs — pages 209-213



X630-3100  
Guest Chair  
With Arms



X640-0140  
Seminar Chair  
With Arms



X640-0040  
Seminar Chair  
Without Arms



X641-2140  
Advanced  
Seminar Chair  
With Arms



X641-2040  
Advanced  
Seminar Chair  
Without Arms

# Statement of Line

## Maari Sled Base Chair — pages 217-218



S7H-44-1H  
With Arms  
Without Optional  
Upholstered Pad



S7H-24-1H  
With Arms  
With Upholstered  
Seat Pad



S7H-22-1H  
With Arms  
With Upholstered  
Seat and Back Pad



S7H-44-0H  
Without Arms  
Without Optional  
Upholstered Pad



S7H-24-0H  
Without Arms  
With Upholstered  
Seat Pad



S7H-22-0H  
Without Arms  
With Upholstered  
Seat and Back Pad

## Maari Four-Leg Chair — pages 219-220



S7S-44-11  
With Arms  
Without Optional  
Upholstered Pad



S7S-24-11  
With Arms  
With Upholstered  
Seat Pad



S7S-22-11  
With Arms  
With Upholstered  
Seat and Back Pad



S7S-44-0H  
Without Arms  
Without Optional  
Upholstered Pad



S7S-24-0H  
Without Arms  
With Upholstered  
Seat Pad



S7S-22-0H  
Without Arms  
With Upholstered  
Seat and Back Pad

## Maari Wood-Leg Chair — page 221



S7W-44-0H  
Without Arms  
Without Optional  
Upholstered Pad



S7W-24-0H  
Without Arms  
With Upholstered  
Seat Pad



S7W-22-0H  
Without Arms  
With Upholstered  
Seat and Back Pad

## Maari Four-Star Base Chair — pages 222-223



S74-44-1H  
With Arms  
Without Optional  
Upholstered Pad



S74-24-1H  
With Arms  
With Upholstered  
Seat Pad



S74-22-1H  
With Arms  
With Upholstered  
Seat and Back Pad



S74-44-0H  
Without Arms  
Without Optional  
Upholstered Pad



S74-24-0H  
Without Arms  
With Upholstered  
Seat Pad



S74-22-0H  
Without Arms  
With Upholstered  
Seat and Back Pad

## Maari Five-Star Base Chair — pages 224-225



S75-44-11  
With Arms  
Without Optional  
Upholstered Pad



S75-24-11  
With Arms  
With Upholstered  
Seat Pad



S75-22-11  
With Arms  
With Upholstered  
Seat and Back Pad



S75-44-01  
Without Arms  
Without Optional  
Upholstered Pad



S75-24-01  
Without Arms  
With Upholstered  
Seat Pad



S75-22-01  
Without Arms  
With Upholstered  
Seat and Back Pad

# Statement of Line

## Maari Sled Base Stool — page 226-227



S7HB-44-0H  
S7HC-44-0H  
**Standard Back**  
Without Optional  
Upholstered Pad



S7HB-24-0H  
S7HC-24-0H  
**Standard Back**  
With Upholstered  
Seat Pad



S7HB-22-0H  
S7HC-22-0H  
**Standard Back**  
With Upholstered  
Seat and Back Pad



S8HB-24-0H  
S8HC-24-0H  
**Low Back**  
With Upholstered  
Seat Pad

## Maari Four-Leg Stool — pages 228-229



S7SB-44-1H  
S7SC-44-1H  
**With Arms**  
Without Optional  
Upholstered Pad



S7SB-24-1H  
S7SC-24-1H  
**With Arms**  
With Upholstered  
Seat Pad



S7SB-22-1H  
S7SC-22-1H  
**With Arms**  
With Upholstered  
Seat and Back Pad



S7SB-44-0H  
S7SC-44-0H  
**Without Arms**  
Without Optional  
Upholstered Pad



S7SB-24-0H  
S7SC-24-0H  
**Without Arms**  
With Upholstered  
Seat Pad



S7SB-22-0H  
S7SC-22-0H  
**Without Arms**  
With Upholstered  
Seat and Back Pad

## Maari Wood-Leg Stool — page 230-231



S7WB-44-0H  
S7WC-44-0H  
**Standard Back**  
Without Optional  
Upholstered Pad



S7WB-24-0H  
S7WC-24-0H  
**Standard Back**  
With Upholstered  
Seat Pad



S7WB-22-0H  
S7WC-22-0H  
**Standard Back**  
With Upholstered  
Seat and Back Pad



S8WB-24-0H  
S8WC-24-0H  
**Low Back**  
With Upholstered  
Seat Pad

## Candor Modern Seating — page 234



SAS-22-A1A  
**Fully Upholstered**  
Seat and Back



SAS-22-A3A  
**Fully Upholstered**  
Seat and 1/2 Back

## Composites Chair/Stool — page 235



4045-00  
**Arc Arm,**  
Upholstered Back

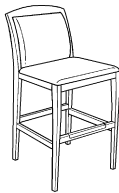

4049-00  
**Stool, Armless,**  
Upholstered Back

# Statement of Line

## Riverbend Straight — pages 243- 245

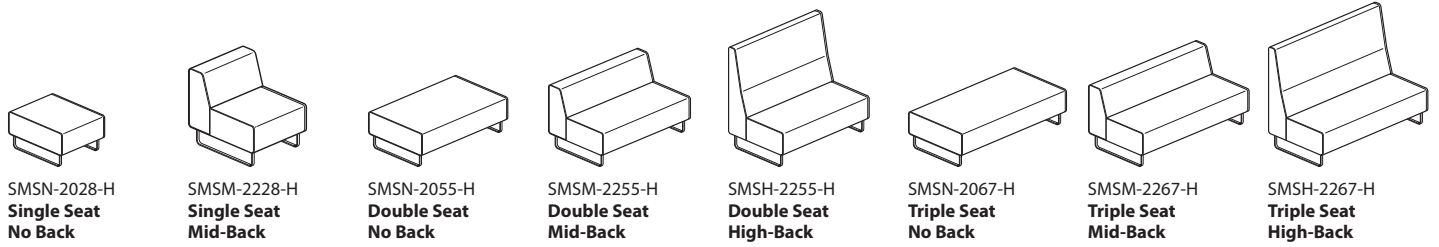

## Riverbend Curved – 90° Concave — page 246

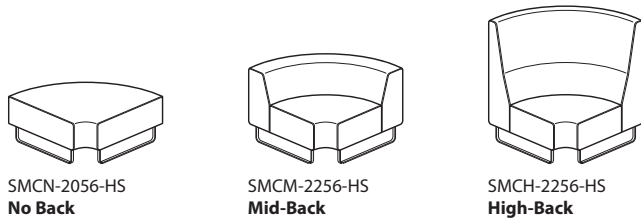

## Riverbend Curved – 60° Concave — page 247

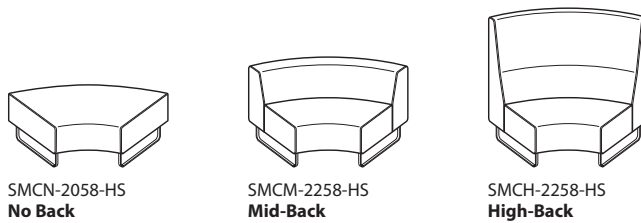

## Riverbend Curved – 60° Convex — page 248

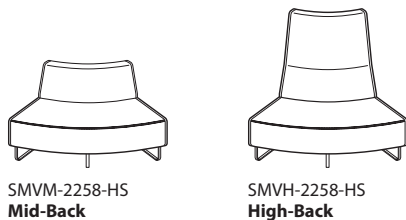

## Riverbend Corner – Square — page 249

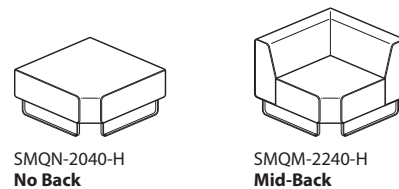

## Pebble – Ottoman — page 250

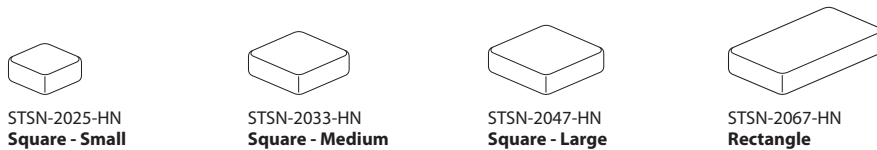

## Riverbend Accessories – Ganging Bracket— page 251

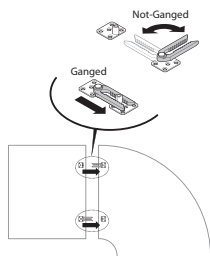

SMG-1

## Statement of Line

### Riverbend Power Module — page 252

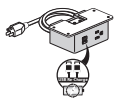

EUSM-PF0W-1100  
EUSM-PLOW-1100  
**Corded**

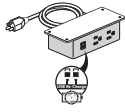

EUSM-PF0W-2100  
EUSM-PLOW-2100  
**Corded**

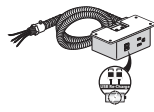

EUSM-HF0W-1100  
EUSM-HLOW-1100  
**Hardwire**

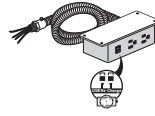

EUSM-HF0W-2100  
EUSM-HLOW-2100  
**Hardwire**

### Openst Collection Plume Screens — page 253

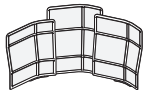

SON-3  
**Plume 3**

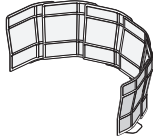

SON-6  
**Plume 6**

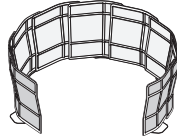

SON-9  
**Plume 9**

### Openst Collection Feather Sofa — page 254

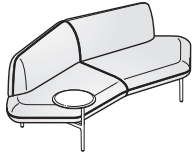

SOSS-1-RW  
**Symmetrical**

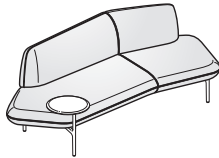

SOSR-1-RW  
**Asymmetrical**

### Openst Collection Chick Pouf — pages 255-257

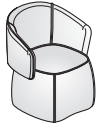

SOPB-2223  
**Chick Pouf with Back**



SOPN-2223  
**Chick Pouf without Back**

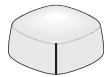

SOPN-2238  
**Large Square - No Back**

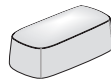

SOPN-2252  
**Rectangle - No Back**



SOPN-2265  
**Round - No Back**

### Openst Collection Sprig Tables — page 258

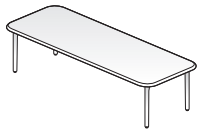

SORA-5320-P  
**Rectangle**



SODC-1616-P  
**Round - 16"**



SODB-2424-P  
**Round - 24"**

### Pip — page 259



STP-P26-TH  
**Personal Laptop Table**

# Statement of Line

## Poppy Guest — pages 262-263



SPG-11-4  
Four Star Base  
with Glides



SPG-11-5  
Five Star Base  
with Casters



SPG-11-7  
Sled Base



SPG-11-W  
Wood Base



SLP-22-T  
Basket



SLP-22-S  
SLP-22-R  
Swivel

## Harbor Work Lounge — pages 266-269



SHL-22-1R10  
Fully Upholstered  
Lounge Chair  
With Wing



SHL-22-1R12  
Fully Upholstered  
Lounge Chair  
With Wing and Tablet



SHO-22-G  
Fully Upholstered  
Ottoman



SHL-25-1L10  
Partially Upholstered  
Lounge Chair  
With Wing



SHL-25-1L12  
Partially Upholstered  
Lounge Chair  
With Wing and Tablet



SHO-25-G  
Partially Upholstered  
Ottoman

## Hello Lounge Seating with Legs — page 270

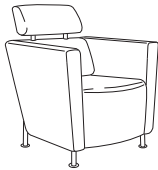

4854-0011  
Standard Arm

## ToDo Stationary & Mobile Seating — pages 273-274



TQ84-0011  
Single, Stationary

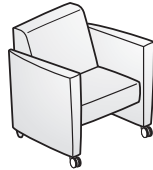

TQ85-0011  
Single, Mobile

## Tilt Stool — page 275



STS-1  
Stool

This page intentionally blank



**Fern**  
General Specifications

**General Guidelines for Product Specification**

	<u>S</u>	<u>F</u>	<u>T</u> -	<u>U</u>	<u>0</u> -	<u>1</u>	<u>S</u>	<u>1</u>	<u>4</u>	<u>A</u>	<u>T</u>	<u>3A-18</u>	<u>MB-BE</u>	<u>TR-F</u>	<u>TR-TF</u>
Product Type	_____	_____	_____	_____	_____	_____	_____	_____	_____	_____	_____	_____	_____	_____	_____
(S) Seating															
Product Line	_____	_____	_____	_____	_____	_____	_____	_____	_____	_____	_____	_____	_____	_____	_____
(F) Fern															
Model (Product Type)	_____	_____	_____	_____	_____	_____	_____	_____	_____	_____	_____	_____	_____	_____	_____
(T) Task															
(S) Stool															
(E) Executive															
Seat (UPH)	_____	_____	_____	_____	_____	_____	_____	_____	_____	_____	_____	_____	_____	_____	_____
(U) Upholstery															
Back Upholstery	_____	_____	_____	_____	_____	_____	_____	_____	_____	_____	_____	_____	_____	_____	_____
(0) Mesh															
(U) Knit/Upholstery															
Arms	_____	_____	_____	_____	_____	_____	_____	_____	_____	_____	_____	_____	_____	_____	_____
(0) No Arms															
(1) Fixed Arms															
(4) Height Adjustable															
(7) 4D Arms															
Arm Cap	_____	_____	_____	_____	_____	_____	_____	_____	_____	_____	_____	_____	_____	_____	_____
(S) Soft Cap															
(N) No Cap															
(L) Leather Cap (fixed arms only)															
Lumbar	_____	_____	_____	_____	_____	_____	_____	_____	_____	_____	_____	_____	_____	_____	_____
(0) No Lumbar															
(1) Lumbar															
Control	_____	_____	_____	_____	_____	_____	_____	_____	_____	_____	_____	_____	_____	_____	_____
(1) Pneumatic w/Back Stop															
(4) Pneumatic/Back Stop & Forward Tilt															
Seat Adjustment	_____	_____	_____	_____	_____	_____	_____	_____	_____	_____	_____	_____	_____	_____	_____
(A) Adjustable															
(F) Fixed															
Base & Caster Combo	_____	_____	_____	_____	_____	_____	_____	_____	_____	_____	_____	_____	_____	_____	_____
(1) Aluminum Hard Casters															
(2) Aluminum Soft Casters															
(T) Aluminum 2 Tone Hard Casters															
(5) Plastic Hard Casters															
(6) Plastic Soft Casters															
(7) Plastic 2 Tone Hard Casters															
(3) Aluminum Low Hard Casters															
(4) Aluminum Low Soft Casters															
Seat Upholstery	_____	_____	_____	_____	_____	_____	_____	_____	_____	_____	_____	_____	_____	_____	_____
Tellure															
Back Mesh	_____	_____	_____	_____	_____	_____	_____	_____	_____	_____	_____	_____	_____	_____	_____
Mesh															
Plastic Trim Color	_____	_____	_____	_____	_____	_____	_____	_____	_____	_____	_____	_____	_____	_____	_____
Plastic Model -															
(spine/wave suspension material/arm caps/levers/base)															
Aluminum Model -															
(spine/wave suspension material/arm caps/levers)															
Aluminum Trim Color	_____	_____	_____	_____	_____	_____	_____	_____	_____	_____	_____	_____	_____	_____	_____
Plastic Model -															
(back and arm upright/mechanism)															
Aluminum Model -															
(back and arm upright/mechanism/base)															

# Fern At-A-Glance

## General Specifications

<b>Designer</b>	Haworth Design Studio, through collaboration with ITO Design.
<b>Fern</b>	A revolutionary chair, backed by 16 patents and on-going research that blends science-based wellness and comfort with sustainability and international design.
<b>Awards</b>	2016 Best of Year award for Task Seating from Interior Design 2017 Red Dot award: Product Design
<b>Environmental Factors</b>	Refer to Product Environmental Data sheet (PED) for recycled content and certifications. Take Back Program - can be easily disassembled at the end of its useful life. Manufactured in a zero landfill, ISO 14001 certified facility in Bruce, MS, USA.
<b>Finishes and Fabrics</b>	A complete listing of finishes and fabrics for Fern seating is available in the back of the price list.
<b>COM &amp; COL General Information</b>	<p>To order a COM fabric (Customer's Own Material) contact the Haworth Inquiry Center (1.800.462.8562), your local Haworth dealer, or go to <a href="http://Surfaces.haworth.com">Surfaces.haworth.com</a> to find out if the COM you have selected has already been tested and approved. The surface collection site also has information on the Haworth alliance program with Carnegie, Luna Textiles, and Maharam as well as our industry-leading Pre-Approved COM program.</p> <p>COM fabrics are placed into Grades based on the cost per linear yard. If a fabric's cost exceeds the range of our highest Grade it will be noted as Non-Graded. The product will be priced at Grade A; the COM fabric costs will appear as a separate line item. The fabric charge will be Haworth's purchase cost plus a 4% administrative fee (based on the cost of the fabric). Yardage calculations will include any applicable fabric repeat.</p> <p>COM Leather products will be priced at a leather Grade A; COL costs will appear as a separate line item. The leather costs will be Haworth's purchase cost plus a 4% administrative fee (based on the cost of the leather).</p>
<b>Stain Repellent</b>	<p>Stain Repellent or Stain Repellent with Moisture Barrier available on fabric surfaces only.</p> <p>Stain Repellent only: To specify add "P" to the end of the product number. Example: SFT-U0-7S02A1P</p> <p>Stain Repellent with Moisture Barrier: To specify add "D" to the end of the product number. Example: SFT-U0-7S02A1D</p>
<b>Shipping Weights/Cube (Including packaging)</b>	<ul style="list-style-type: none"> <li>• Task Chair           <ul style="list-style-type: none"> <li>-With arms - 57 lbs. / 19.14 cubic feet</li> <li>-Armless - 53 lbs. / 19.14 cubic feet</li> </ul> </li> <li>• Task Stool           <ul style="list-style-type: none"> <li>-With arms - 61 lbs. / 22.1 cubic feet</li> <li>-Armless - 57 lbs. / 22.1 cubic feet</li> </ul> </li> </ul>

# Fern At-A-Glance

## General Specifications

### STANDARD MOBILITY AND ADJUSTABILITY

#### Seat Height Adjustment

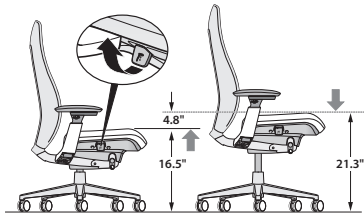

#### Features:

- Pneumatic seat height adjustment.
- Seat height adjusts 5"(127mm) from 16.5" to 21.5"(406mm-533mm) in standard models. Low-position adjusts from 15" to 17.5"(38mm-44mm).

#### Benefits:

- Ensures the comfort of the lower limbs by avoiding pressure on the underside of the thigh caused by a seat pan that is too high, or decreased thigh-to-torso angle if the seat is too low.
- Accommodates users between approximately 4'11"(1499mm) and 6'3"(1905mm) tall to provide good leg circulation.
- Seat height adjustment is important in setting the proper hand position and allowing for proper sitting eye height as well.

#### Seat Depth Adjustment

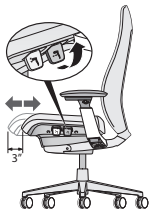

#### Features:

- Optional seat depth has 3"(76mm) seat depth range. Fixed seat also available.

#### Benefit:

- Supports the thighs, allows users to rest against the seat back for back support, and avoids pressure on the back of the knees of small to tall users.

#### Balanced 3-Point Tilt

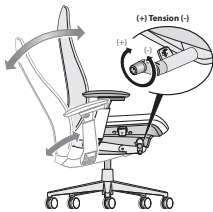

#### Features:

- Balanced 3-point tilt mechanism.
- Back reclines 24° from the upright position.
- Seat pan moves downward 5° from the initial position.

#### Benefits:

- Comfortable relaxed posture.
- Recline allows for the opening of the user's chest cavity providing good airflow to promote alertness.
- Users' feet remain flat on the floor.

#### Tilt Tension Control

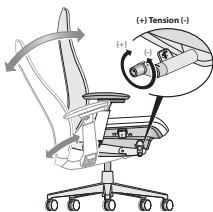

#### Features:

- Regulates the amount of resistance felt when leaning back in the chair and the effort required to recline the chair backwards.

#### Benefit:

- Personalized support to accommodate users of different body types and different work styles.

#### Edgeless Back Design

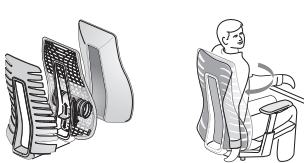

#### Features:

- Edgeless design provides flexibility.
- Patented design with flexible fronds and cradle system provide total back support.

#### Benefit:

- Encourages movement, eliminates pressure point from hard edge.

#### Back Support/ Lumbar Adjustment

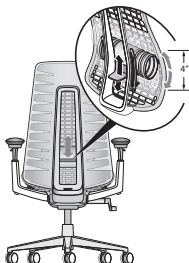

#### Features:

- Total back support, providing pelvic, to lumbar to thoracic support (upper back).
- Optional height adjustable lumbar.
- Range of 4"(102mm) of height adjustment.

#### Benefits:

- Provides additional support in the lower back.
- Lumbar adjustment maintains the natural curvature of the spine at the lower back and allows users to choose the support that feels right for them.
- Integrated passive pelvic support rotates the pelvis forward to maintain the natural spine shape.

# Fern At-A-Glance

## General Specifications

### STANDARD MOBILITY AND ADJUSTABILITY

#### Back Stop



#### Features:

- Back Stop stops in 5 positions - upright and every 7° of back angle.

#### Benefit:

- Allows users the choice of selecting an upright position or limiting the amount of recline while performing different tasks.

#### Forward Tilt



#### Features:

- Optional forward tilt allows seat pan to move downward 5° from the initial position.

#### Benefit:

- Allows user the opportunity to vary their posture throughout the day.

#### 4D Arm

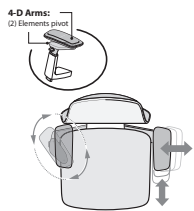

#### Features:

- Optional 4D arm adjusts in 4 ways:
  - Height adjustment 4.8”(122mm)
  - Side-to-side arm cap adjustment range: 15”(381mm) [7.5”(191mm) each arm cap]
  - Front-to-back adjustment range: 3.5”(89mm)
  - Pivoting 40° in and 40° out

#### Benefits:

- Height adjustment offers users varying elbow rest heights so that users avoid lifting their shoulders or leaning sideways to get arm support.
- Front-to-back adjustment adjusts the armrest length, which is important because it allows users to get close to the worksurface while maintaining the effective use of the backrest.
- Side-to-side adjustment ensures a comfortable resting position for the arms with proper support of the forearm while allowing for easy entry/exit of the chair.
- Pivoting provides proper support of the forearm when performing tasks involving keying and mousing.

#### Height Adjustable Arm

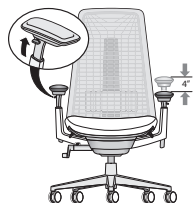

#### Features:

- Optional height adjustable arms adjust 4.8”(122mm) vertically.

#### Benefit:

- Height adjustment accommodates users with varying elbow rest heights so that users avoid lifting their shoulders or leaning sideways to get arm support.

#### Base

##### Standard Plastic Base

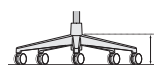

#### Colors:

Fog, Black

#### Casters:

Hard: Black or two-tone grey

Soft: Black

##### Optional Aluminum Base

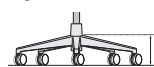

#### Colors:

Painted Metallic Silver, Metallic Champagne, Pitch (textured black), polished aluminum

#### Casters:

Hard: Black or two-tone grey

Soft: Black

##### Low Position Base (Aluminum only)

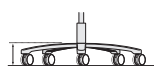

#### Colors:

Painted Metallic Silver, Metallic Champagne, Pitch (textured black)

#### Casters:

Hard: Black or two-tone grey

Soft: Black

# Fern

General Specifications  
UPHOLSTERY / AESTHETIC OPTIONS

## Fern Plastic Model

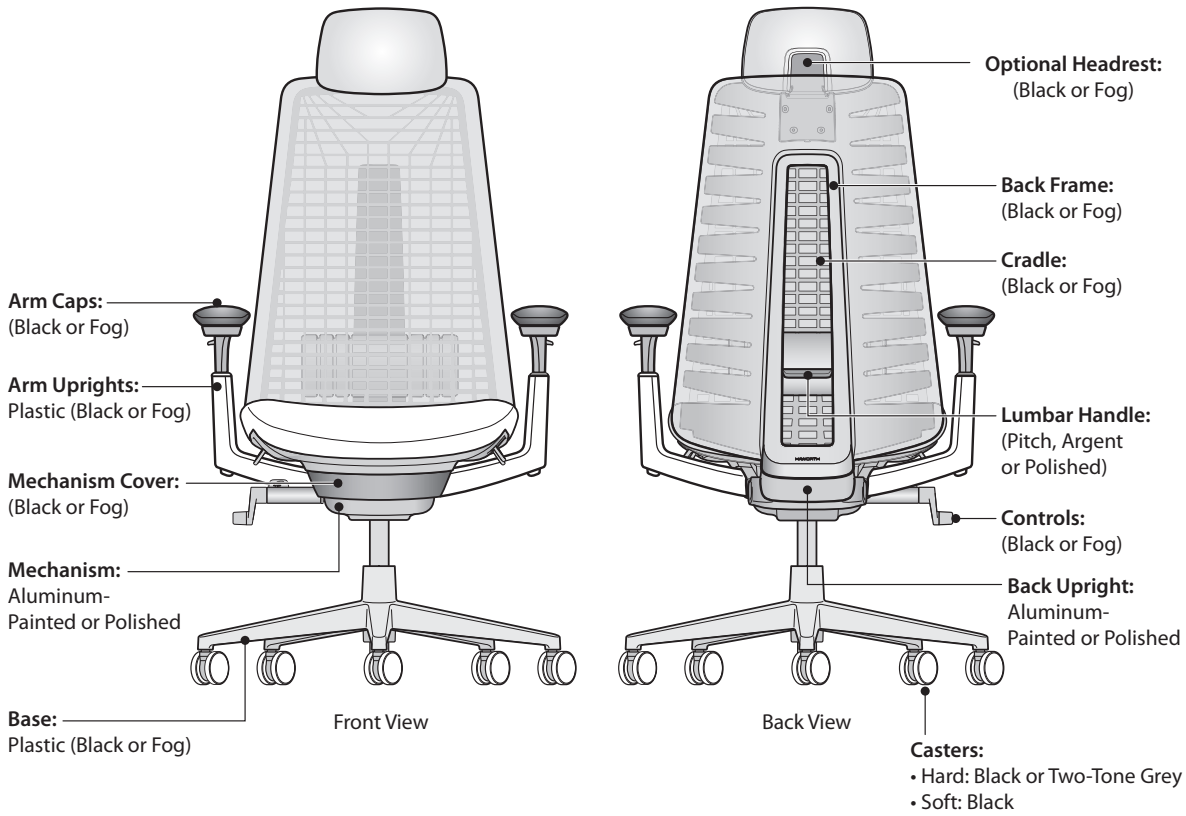

## Fern Aluminum Model

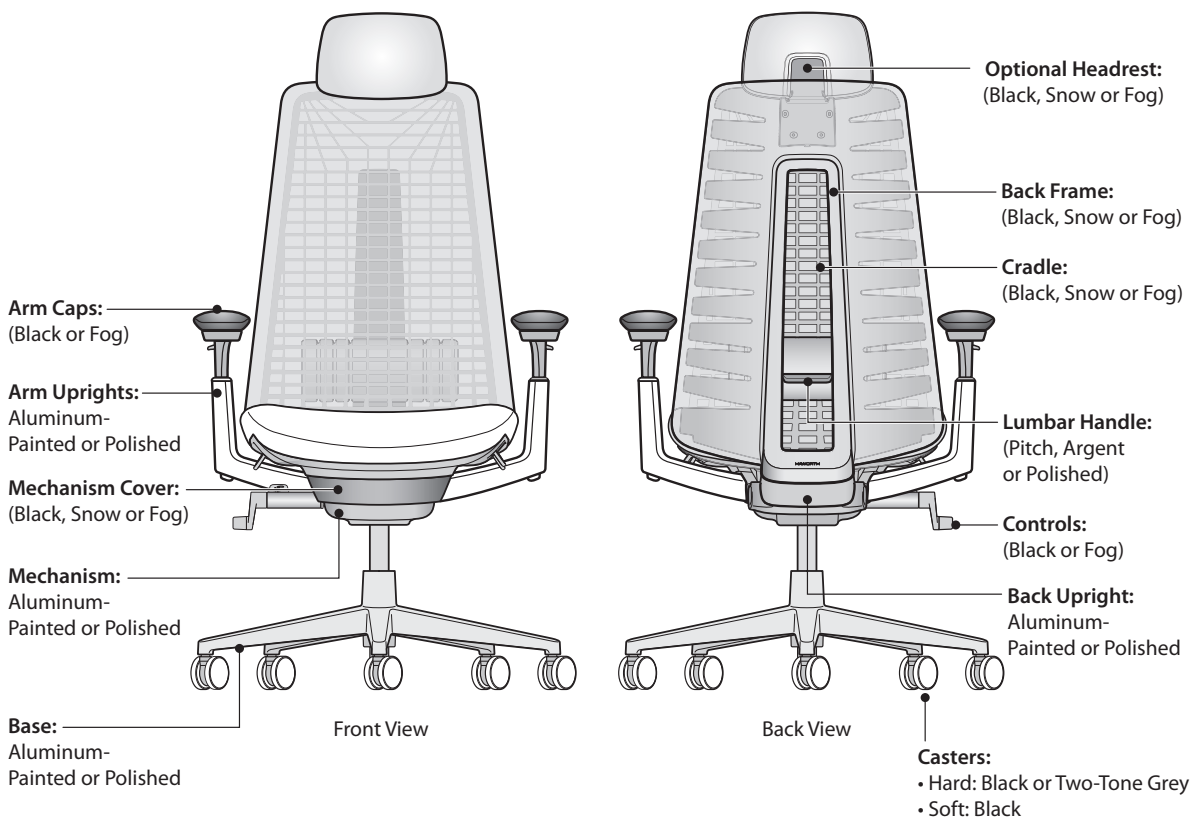

This page intentionally blank

# Fern

## Task Chair with 4D Arms — Plastic Base Model



SFT-U0-7S01A

1st Trim Color (Plastic)	Arm Cap/Levers	Lumbar Handle
TR-F Black	TR-F Black	TR-TF Pitch
TR-7 Fog	TR-7 Fog	TR-AR Argent

### Dimensions

- \*SH: 16.5"-21.5" (419mm-546mm)
- H: 41.5"-47" (1054mm-1194mm)
- D: 28.5"(724mm)
- W: 29"(737mm)
- \*SW: 19.9"(505mm)
- \*AH: 6.7"-11.5" (170mm-292mm)
- \*SD: 15.5"-18.5" (394mm-470mm)

\* All measurements taken with the BIFMA chair measuring device.

### Features

- Back: Flexible back with built in fronds wrapped in lofted mesh, knit or faux leather.
- Seat: Flexible seat pan with standard upholstered foam.
- Standard fixed seat. Optional seat depth adjustment (3"(76mm) range).
- Base: Plastic five-star base. Available in Black or Fog.
- Optional height adjustable lumbar support (4"(102mm) adjustment).
- Arms: 4D arms with plastic upright. –Move fore, aft, side to side and pivot in and out. –Height adjustment range of 4.8"(122mm).
- Arm Caps: Standard with soft arm caps.
- Optional headrest has an upholstered front with a plastic back. Headrest material and trim color are matched to the back.
- Mechanism: Synchronized 3-point tilt; standard tilt tension adjustment.
- Height Adjustment: Pneumatic. Range: 16.5"-21.5"(419mm-546mm).
- Back Stop: 5 positions.
- Optional Forward Tilt (with Back Stop): 5° downward from initial position.
- Casters: Hard casters in black or two-tone grey; Soft casters black only.
- COM yardage / COL square footage: (Seat only) 0.71/8

### To Order, Specify:

1) Product number, including;

#### 1) Caster Option:

- 5 Hard Casters (Black)
- 6 Soft Casters (Black), add \$60.15 to list
- 7 Hard Two-Tone Casters (Grey)

- 2) Fabric surface and color (seat).
- 3) Mesh, knit or faux leather color (back).
- 4) Plastic trim color (back frame/cradle/arm uprights/base).
- 5) Aluminum trim color (back upright and mechanism). (Add \$140.81 list for polished aluminum back upright and mechanism.)

### Specification Tip

- When Polished Aluminum trim is specified, lumbar handle will default to Polished Aluminum.

Description	Number	Fabric Grade								Leather Grade A	Leather Grade B	
		1	A	B	C	D	E	F	G			H
<b>Mesh Back, No Lumbar Adjustment</b>												
Back Stop w/Seat Depth Adjustment	SFT-U0-7S01A		\$1909.01	\$1962.20	\$2018.55	\$2046.70	\$2067.06	\$2117.14	\$2164.08	\$2287.67	\$2375.30	\$2597.50
Back Stop Forward Tilt w/Seat Depth Adjustment	SFT-U0-7S04A		2034.19	2087.38	2143.73	2171.88	2192.24	2242.32	2289.26	2412.85	2500.48	2722.68
<b>Knit Back, No Lumbar Adjustment</b>												
Back Stop w/Seat Depth Adjustment	SFT-UU-7S01A		\$2159.28	\$2212.47	\$2268.82	\$2296.97	\$2317.33	\$2367.41	\$2414.35	\$2537.94	\$2625.57	\$2847.77
Back Stop Forward Tilt w/Seat Depth Adjustment	SFT-UU-7S04A		2284.46	2337.65	2394.00	2422.15	2442.51	2492.59	2539.53	2663.12	2750.75	2972.95
<b>Mesh Back, Lumbar Adjustment</b>												
Back Stop w/Seat Depth Adjustment	SFT-U0-7S11A		\$2049.82	\$2103.01	\$2159.36	\$2187.51	\$2207.87	\$2257.95	\$2304.89	\$2428.48	\$2516.11	\$2738.31
Back Stop Forward Tilt w/Seat Depth Adjustment	SFT-U0-7S14A		2175.00	2228.19	2284.54	2312.69	2333.05	2383.13	2430.07	2553.66	2641.29	2863.49
<b>Knit Back, Lumbar Adjustment</b>												
Back Stop w/Seat Depth Adjustment	SFT-UU-7S11A		\$2300.09	\$2353.28	\$2409.63	\$2437.78	\$2458.14	\$2508.22	\$2555.16	\$2678.75	\$2766.38	\$2988.58
Back Stop Forward Tilt w/Seat Depth Adjustment	SFT-UU-7S14A		2425.27	2478.46	2534.81	2562.96	2583.32	2633.40	2680.34	2803.93	2891.56	3113.76

The following options require modification of the product number.

Fixed seat	To specify, change the 10th digit from an <b>A</b> to <b>F</b> ; <b>Example:</b> SFT-U0-7S01F5
Faux Leather back	To specify, change the fifth digit in the product number to <b>U</b> ; <b>Example:</b> SFT-UU-7S01A5 (Wellington; add \$179.95 list, Brisa; add \$464.73 list)
Headrest	To specify, change the third digit from a <b>T</b> to an <b>E</b> ; <b>Example:</b> SFE-U0-7S01A5 (Mesh; add \$210.63 list, Faux Leather; add \$273.21 list)
Stain repellent (Seat only)	To specify, add <b>P</b> to the end of the product number and add \$54.77 list; <b>Example:</b> SFT-U0-7S01A5P

# Fern

## Task Chair with 4D Arms — Aluminum Base Model



SFT-U0-7501A

### Dimensions

- \*SH: 16.5"-21.5"  
(419mm-546mm)
- H: 41.5"-47"  
(1054mm-1194mm)
- D: 28.5"(724mm)
- W: 29"(737mm)
- \*SW: 19.9"(505mm)
- \*AH: 6.7"-11.5"  
(170mm-292mm)
- \*SD: 15.5"-18.5"  
(394mm-470mm)

Low position seat height:  
15"-17.5"  
(381mm-445mm)

\* All measurements taken with the BIFMA chair measuring device.

### Features

- Back: Flexible back with built in fronds wrapped in lofted mesh, knit or faux leather.
- Seat: Flexible seat pan with standard upholstered foam.
- Standard fixed seat. Optional seat depth adjustment (3"(76mm) range).
- Base: Aluminum five-star base.
- Optional height adjustable lumbar support (4"(102mm) adjustment).
- Arms: 4D arms with aluminum upright.
  - Move fore, aft, side to side and pivot in and out.
  - Height adjustment range of 4.8"(122mm).
- Arm Caps: Standard with soft arm caps.
- Optional headrest has an upholstered front with a plastic back. Headrest material and trim color are matched to the back.
- Mechanism: Synchronized 3-point tilt; standard tilt tension adjustment.
- Height Adjustment: Pneumatic or optional low position. Range: 15"-17.5"(381mm-445mm).
- Back Stop: 5 positions.
- Optional Forward Tilt (with Back Stop): 5° downward from initial position.
- Casters: Hard casters in black or two-tone grey; Soft casters black only.
- COM yardage / COL square footage: (Seat only) 0.71/8

### To Order, Specify:

1) Product number, including;

#### 1) Caster Option: Standard Base

- 1** Std. Base Hard Casters (Black)
- 2** Std. Base Soft Casters (Black), add **\$60.15** to list
- T** Std. Base Hard Two-Tone Casters (Grey)

#### Low Base

- 3** Low Base, Hard Casters (Black)
- 4** Low Base, Soft Casters (Black), add **\$60.15** to list

2) Fabric surface and color (seat).

3) Mesh, knit or faux leather color (back).

4) Plastic trim color (back frame/cradle). (Add **\$86.06** list for Snow TR-UFM for back frame/cradle.)

5) Aluminum trim color (back and arm upright/mechanism/base). (Add **\$140.81** list for polished aluminum.)

1st Trim Color (Plastic)	Arm Cap/Levers	Lumbar Handle
TR-F Black	TR-F Black	TR-TF Pitch
TR-7 Fog	TR-7 Fog	TR-AR Argent
TR-UFM Snow	TR-7 Fog	TR-FS Snowfall
TR-UFM Snow w/2nd trim PM-P Polished Aluminum	TR-7 Fog	PM-P Polished Aluminum

### Specification Tip

- When Polished Aluminum trim is specified, lumbar handle will default to Polished Aluminum.

Description	Number <b>1</b>	Fabric Grade								Leather Grade A	Leather Grade B
		A	B	C	D	E	F	G	H		
<b>Mesh Back, No Lumbar Adjustment</b>											
Back Stop w/Seat Depth Adjustment	SFT-U0-7501A	\$2146.85	\$2200.04	\$2256.39	\$2284.54	\$2304.90	\$2354.98	\$2401.92	\$2525.51	\$2613.14	\$2835.34
Back Stop Forward Tilt w/Seat Depth Adjustment	SFT-U0-7504A	\$2272.03	\$2325.22	\$2381.57	\$2409.72	\$2430.08	\$2480.16	\$2527.10	\$2650.69	\$2738.32	\$2960.52
<b>Knit Back, No Lumbar Adjustment</b>											
Back Stop w/Seat Depth Adjustment	SFT-UU-7501A	\$2397.12	\$2450.31	\$2506.66	\$2534.81	\$2555.17	\$2605.25	\$2652.19	\$2775.78	\$2863.41	\$3085.61
Back Stop Forward Tilt w/Seat Depth Adjustment	SFT-UU-7504A	\$2522.30	\$2575.49	\$2631.84	\$2659.99	\$2680.35	\$2730.43	\$2777.37	\$2900.96	\$2988.59	\$3210.79
<b>Mesh Back, Lumbar Adjustment</b>											
Back Stop w/Seat Depth Adjustment	SFT-U0-7511A	\$2287.66	\$2340.85	\$2397.20	\$2425.35	\$2445.71	\$2495.79	\$2542.73	\$2666.32	\$2753.95	\$2976.15
Back Stop Forward Tilt w/Seat Depth Adjustment	SFT-U0-7514A	\$2412.84	\$2466.03	\$2522.38	\$2550.53	\$2570.89	\$2620.97	\$2667.91	\$2791.50	\$2879.13	\$3101.33
<b>Knit Back, Lumbar Adjustment</b>											
Back Stop w/Seat Depth Adjustment	SFT-UU-7511A	\$2537.93	\$2591.12	\$2647.47	\$2675.62	\$2695.98	\$2746.06	\$2793.00	\$2916.59	\$3004.22	\$3226.42
Back Stop Forward Tilt w/Seat Depth Adjustment	SFT-UU-7514A	\$2663.11	\$2716.30	\$2772.65	\$2800.80	\$2821.16	\$2871.24	\$2918.18	\$3041.77	\$3129.40	\$3351.60

The following options require modification of the product number.

- Fixed seat To specify, change the 10th digit from an **A** to **F**; **Example:** SFT-U0-7501**F1**
- Faux Leather back To specify, change the fifth digit in the product number to **U**; **Example:** SFT-UU-7501**A1** (Wellington; add **\$179.95** list, Brisa; add **\$464.73** list)
- Headrest To specify, change the third digit from a **T** to an **E**; **Example:** SFE-U0-7501**A1** (Mesh; add **\$210.63** list, Faux Leather; add **\$273.21** list)
- Stain repellent (Seat only) To specify, add **P** to the end of the product number and add **\$54.77** list; **Example:** SFT-U0-7501**A1P**



# Fern

## Task Chair with Height Adjustable Arms — Plastic Base Model



SFT-U0-4S01A

1st Trim Color (Plastic)	Arm Cap/Levers	Lumbar Handle
TR-F Black	TR-F Black	TR-TF Pitch
TR-7 Fog	TR-7 Fog	TR-AR Argent

### Dimensions

- \*SH: 16.5"-21.5"  
(419mm-546mm)
- H: 41.5"-47"  
(1054mm-1194mm)
- D: 28.5"(724mm)
- W: 29"(737mm)
- \*SW: 19.9"(505mm)
- \*AH: 6.7"-11.5"  
(170mm-292mm)
- \*SD: 15.5"-18.5"  
(394mm-470mm)

\* All measurements taken with the BIFMA chair measuring device.

### Features

- Back: Flexible back with built in fronds wrapped in lofted mesh, knit or faux leather.
- Seat: Flexible seat pan with standard upholstered foam.
- Standard fixed seat. Optional seat depth adjustment (3"(76mm) range).
- Base: Plastic five-star base. Available in Black or Fog.
- Optional height adjustable lumbar support (4"(102mm) adjustment).
- Arms: Height Adjustable with soft arm caps. Adjustment range of 4.8"(122mm).
- Optional headrest has an upholstered front with a plastic back. Headrest material and trim color are matched to the back.
- Mechanism: Synchronized 3-point tilt; standard tilt tension adjustment.
- Height Adjustment: Pneumatic. Range: 16.5"-21.5"(419mm-546mm).
- Back Stop: 5 positions.
- Optional Forward Tilt (with Back Stop): 5° downward from initial position.
- Casters: Hard casters in black or two-tone grey; Soft casters black only.
- COM yardage / COL square footage: (Seat only) 0.71/8

### To Order, Specify:

1) Product number, including;

#### 1 Caster Option:

- 5 Hard Casters (Black)
- 6 Soft Casters (Black), add \$60.15 to list
- 7 Hard Two-Tone Casters (Grey)

- 2) Fabric surface and color (seat).
- 3) Mesh, knit or faux leather color (back).
- 4) Plastic trim color (back frame/cradle/arm uprights/base).
- 5) Aluminum trim color (back upright and mechanism). (Add \$140.81 list for polished aluminum back upright and mechanism.)

### Specification Tip

- When Polished Aluminum trim is specified, lumbar handle will default to Polished Aluminum.

Description	Number ①	Fabric Grade								Leather Grade A	Leather Grade B
		A	B	C	D	E	F	G	H		
<b>Mesh Back, No Lumbar Adjustment</b>											
Back Stop w/Seat Depth Adjustment	SFT-U0-4S01A	\$1869.91	\$1923.10	\$1979.45	\$2007.60	\$2027.96	\$2078.04	\$2124.98	\$2248.57	\$2336.20	\$2558.40
Back Stop Forward Tilt w/Seat Depth Adjustment	SFT-U0-4S04A	1995.09	2048.28	2104.63	2132.78	2153.14	2203.22	2250.16	2373.75	2461.38	2683.58
<b>Knit Back, No Lumbar Adjustment</b>											
Back Stop w/Seat Depth Adjustment	SFT-UU-4S01A	\$2120.18	\$2173.37	\$2229.72	\$2257.87	\$2278.23	\$2328.31	\$2375.25	\$2498.84	\$2586.47	\$2808.67
Back Stop Forward Tilt w/Seat Depth Adjustment	SFT-UU-4S04A	2245.36	2298.55	2354.90	2383.05	2403.41	2453.49	2500.43	2624.02	2711.65	2933.85
<b>Mesh Back, Lumbar Adjustment</b>											
Back Stop w/Seat Depth Adjustment	SFT-U0-4S11A	\$2010.72	\$2063.91	\$2120.26	\$2148.41	\$2168.77	\$2218.85	\$2265.79	\$2389.38	\$2477.01	\$2699.21
Back Stop Forward Tilt w/Seat Depth Adjustment	SFT-U0-4S14A	2135.90	2189.09	2245.44	2273.59	2293.95	2344.03	2390.97	2514.56	2602.19	2824.39
<b>Knit Back, Lumbar Adjustment</b>											
Back Stop w/Seat Depth Adjustment	SFT-UU-4S11A	\$2260.99	\$2314.18	\$2370.53	\$2398.68	\$2419.04	\$2469.12	\$2516.06	\$2639.65	\$2727.28	\$2949.48
Back Stop Forward Tilt w/Seat Depth Adjustment	SFT-UU-4S14A	2386.17	2439.36	2495.71	2523.86	2544.22	2594.30	2641.24	2764.83	2852.46	3074.66

The following options require modification of the product number.

- Fixed seat To specify, change the 10th digit from an **A** to **F**; **Example:** SFT-U0-4S01F5
- Faux Leather back To specify, change the fifth digit in the product number to **U**; **Example:** SFT-UU-4S01A5 (Wellington; add \$179.95 list, Brisa; add \$464.73 list)
- Headrest To specify, change the third digit from a **T** to an **E**; **Example:** SFE-U0-4S01A5 (Mesh; add \$210.63 list, Faux Leather; add \$273.21 list)
- Stain repellent (Seat only) To specify, add **P** to the end of the product number and add \$54.77 list; **Example:** SFT-U0-4S01kA5P

# Fern

## Task Chair with Height Adjustable Arms — Aluminum Base Model



SFT-U0-4S01A

### Dimensions

- \*SH: 16.5"-21.5"  
(419mm-546mm)
- H: 41.5"-47"  
(1054mm-1194mm)
- D: 28.5"(724mm)
- W: 29"(737mm)
- \*SW: 19.9"(505mm)
- \*AH: 6.7"-11.5"  
(170mm-292mm)
- \*SD: 15.5"-18.5"  
(394mm-470mm)

Low position seat height:  
15"-17.5"  
(381mm-445mm)

\* All measurements taken with the BIFMA chair measuring device.

1st Trim Color (Plastic)	Arm Cap/Levers	Lumbar Handle
TR-F Black	TR-F Black	TR-TF Pitch
TR-7 Fog	TR-7 Fog	TR-AR Argent
TR-UFM Snow	TR-7 Fog	TR-FS Snowfall
TR-UFM Snow w/2nd trim PM-P Polished Aluminum	TR-7 Fog	PM-P Polished Aluminum

### Features

- Back: Flexible back with built in fronds wrapped in lofted mesh, knit or faux leather.
- Seat: Flexible seat pan with standard upholstered foam.
- Standard fixed seat. Optional seat depth adjustment (3"(76mm) range).
- Base: Aluminum five-star base.
- Optional height adjustable lumbar support (4"(102mm) adjustment).
- Arms: Height Adjustable with soft arm caps. Adjustment range of 4.8"(122mm).
- Optional headrest has an upholstered front with a plastic back. Headrest material and trim color are matched to the back.
- Mechanism: Synchronized 3-point tilt; standard tilt tension adjustment.
- Height Adjustment: Pneumatic or optional low position. Range: 15"-17.5"(381mm-445mm).
- Back Stop: 5 positions.
- Optional Forward Tilt (with Back Stop): 5° downward from initial position.
- Casters: Hard casters in black or two-tone grey; Soft casters black only.
- COM yardage / COL square footage: (Seat only) 0.71/8

### Specification Tip

- When Polished Aluminum trim is specified, lumbar handle will default to Polished Aluminum.

### To Order, Specify:

- 1) Product number, including;

#### 1 Caster Option: Standard Base

- 1 Std. Base Hard Casters (Black)
- 2 Std. Base Soft Casters (Black), add **\$60.15** to list
- T Std. Hard Base Two-Tone Casters (Grey)

#### Low Base

- 3 Low Base, Hard Casters (Black)
- 4 Low Base, Soft Casters (Black), add **\$60.15** to list

- 2) Fabric surface and color (seat).
- 3) Mesh, knit or faux leather color (back).
- 4) Plastic trim color (back frame/cradle). (Add **\$86.06** list for Snow TR-UFM for back frame/cradle.)
- 5) Aluminum trim color (back and arm upright/mechanism/base). (Add **\$140.81** list for polished aluminum.)

Description	Number 1	Fabric Grade								Leather Grade A	Leather Grade B
		A	B	C	D	E	F	G	H		
<b>Mesh Back, No Lumbar Adjustment</b>											
Back Stop w/Seat Depth Adjustment	SFT-U0-4S01A	\$2107.75	2160.94	2217.29	2245.44	2265.80	2315.88	2362.82	2486.41	2574.04	2796.24
Back Stop Forward Tilt w/Seat Depth Adjustment	SFT-U0-4S04A	2232.93	2286.12	2342.47	2370.62	2390.98	2441.06	2488.00	2611.59	2699.22	2921.42
<b>Knit Back, No Lumbar Adjustment</b>											
Back Stop w/Seat Depth Adjustment	SFT-UU-4S01A	\$2358.02	2411.21	2467.56	2495.71	2516.07	2566.15	2613.09	2736.68	2824.31	3046.51
Back Stop Forward Tilt w/Seat Depth Adjustment	SFT-UU-4S04A	2483.20	2536.39	2592.74	2620.89	2641.25	2691.33	2738.27	2861.86	2949.49	3171.69
<b>Mesh Back, Lumbar Adjustment</b>											
Back Stop w/Seat Depth Adjustment	SFT-U0-4S11A	\$2248.56	2301.75	2358.10	2386.25	2406.61	2456.69	2503.63	2627.22	2714.85	2937.05
Back Stop Forward Tilt w/Seat Depth Adjustment	SFT-U0-4S14A	2373.74	2426.93	2483.28	2511.43	2531.79	2581.87	2628.81	2752.40	2840.03	3062.23
<b>Knit Back, Lumbar Adjustment</b>											
Back Stop w/Seat Depth Adjustment	SFT-UU-4S11A	\$2498.83	2552.02	2608.37	2636.52	2656.88	2706.96	2753.90	2877.49	2965.12	3187.32
Back Stop Forward Tilt w/Seat Depth Adjustment	SFT-UU-4S14A	2624.01	2677.20	2733.55	2761.70	2782.06	2832.14	2879.08	3002.67	3090.30	3312.50

The following options require modification of the product number.

- Fixed seat To specify, change the 10th digit from an **A** to **F**; **Example:** SFT-U0-4S01F1
- Faux Leather back To specify, change the fifth digit in the product number to **U**; **Example:** SFT-UU-4S01A1 (Wellington; add **\$179.95** list, Brisa; add **\$464.73** list)
- Headrest To specify, change the third digit from a **T** to an **E**; **Example:** SFE-U0-4S01A1 (Mesh; add **\$210.63** list, Faux Leather; add **\$273.21** list)
- Stain repellent (Seat only) To specify, add **P** to the end of the product number and add **\$54.77** list; **Example:** SFT-U0-4S01A1P

# Fern

## Task Chair with Fixed Arms — Plastic Base Model



SFT-U0-1S01A

1st Trim Color (Plastic)	Arm Cap/Levers	Lumbar Handle
TR-F Black	TR-F Black	TR-TF Pitch
TR-7 Fog	TR-7 Fog	TR-AR Argent

### Dimensions

- \*SH: 16.5"-21.5" (419mm-546mm)
- H: 41.5"-47" (1054mm-1194mm)
- D: 28.5"(724mm)
- W: 29"(737mm)
- \*SW: 19.9"(505mm)
- \*AH: 9"(229mm)
- \*SD: 15.5"-18.5" (394mm-470mm)

\* All measurements taken with the BIFMA chair measuring device.

### Features

- Back: Flexible back with built in fronds wrapped in lofted mesh, knit or faux leather.
- Seat: Flexible seat pan with standard upholstered foam.
- Standard fixed seat. Optional seat depth adjustment (3"(76mm) range).
- Base: Plastic five-star base. Available in Black or Fog.
- Optional height adjustable lumbar support (4"(102mm) adjustment).
- Arms: Fixed aluminum arms with soft arm caps.
- Optional leather arm cap available when ordering a leather seat. Leather arm cap coordinates with leather seat selection.
- Optional headrest has an upholstered front with a plastic back. Headrest material and trim color are matched to the back.
- Mechanism: Synchronized 3-point tilt; standard tilt tension adjustment.
- Height Adjustment: Pneumatic. Range: 15"-17.5"(381mm-445mm).
- Back Stop: 5 positions.
- Optional Forward Tilt (with Back Stop): 5° downward from initial position.
- Casters: Hard casters in black or two-tone grey; Soft casters black only.
- COM yardage / COL square footage: (Seat only) 0.71/8

### To Order, Specify:

- 1) Product number, including;
  - 1** **Caster Option:**
    - 5** Hard Casters (Black)
    - 6** Soft Casters (Black), add **\$60.15** to list
    - 7** Hard Two-Tone Casters (Grey)
- 2) Fabric surface and color (seat).
- 3) Mesh, knit or faux leather color (back).
- 4) Plastic trim color (back frame/cradle/base).
- 5) Aluminum trim color (back upright/arm uprights/mechanism). (Add **\$140.81** list for polished aluminum back upright and mechanism.)

### Specification Tip

- When Polished Aluminum trim is specified, lumbar handle will default to Polished Aluminum.

Description	Number <b>1</b>	Fabric Grade								Leather Grade A	Leather Grade B
		A	B	C	D	E	F	G	H		
<b>Mesh Back, No Lumbar Adjustment</b>											
Back Stop w/Seat Depth Adjustment	SFT-U0-1S01A	\$1846.43	\$1899.62	\$1955.97	\$1984.12	\$2004.48	\$2054.56	\$2101.50	\$2225.09	\$2312.72	\$2534.92
Back Stop Forward Tilt w/Seat Depth Adjustment	SFT-U0-1S04A	1971.61	2024.80	2081.15	2109.30	2129.66	2179.74	2226.68	2350.27	2437.90	2660.10
<b>Knit Back, No Lumbar Adjustment</b>											
Back Stop w/Seat Depth Adjustment	SFT-UU-1S01A	\$2096.70	\$2149.89	\$2206.24	\$2234.39	\$2254.75	\$2304.83	\$2351.77	\$2475.36	\$2562.99	\$2785.19
Back Stop Forward Tilt w/Seat Depth Adjustment	SFT-UU-1S04A	2221.88	2275.07	2331.42	2359.57	2379.93	2430.01	2476.95	2600.54	2688.17	2910.37
<b>Mesh Back, Lumbar Adjustment</b>											
Back Stop w/Seat Depth Adjustment	SFT-U0-1S11A	\$1987.24	\$2040.43	\$2096.78	\$2124.93	\$2145.29	\$2195.37	\$2242.31	\$2365.90	\$2453.53	\$2675.73
Back Stop Forward Tilt w/Seat Depth Adjustment	SFT-U0-1S14A	2112.42	2165.61	2221.96	2250.11	2270.47	2320.55	2367.49	2491.08	2578.71	2800.91
<b>Knit Back, Lumbar Adjustment</b>											
Back Stop w/Seat Depth Adjustment	SFT-UU-1S11A	\$2237.51	\$2290.70	\$2347.05	\$2375.20	\$2395.56	\$2445.64	\$2492.58	\$2616.17	\$2703.80	\$2926.00
Back Stop Forward Tilt w/Seat Depth Adjustment	SFT-UU-1S14A	2362.69	2415.88	2472.23	2500.38	2520.74	2570.82	2617.76	2741.35	2828.98	3051.18

The following options require modification of the product number.

- Fixed seat To specify, change the 10th digit from an **A** to **F**; **Example:** SFT-U0-1S01F5
- Leather arm cap To specify, change the 7th digit from **S** to **L**; **Example:** SFT-U0-1L01A5 (matches required Leather seat), add **\$109.54** list
- Faux Leather back To specify, change the fifth digit in the product number to **U**; **Example:** SFT-UU-1S01A5 (Wellington; add **\$179.95** list, Brisa; add **\$464.73** list)
- Headrest To specify, change the third digit from a **T** to an **E**; **Example:** SFE-U0-1S01A5 (Mesh; add **\$210.63** list, Faux Leather; add **\$273.21** list)
- Stain repellent (Seat only) To specify, add **P** to the end of the product number and add **\$54.77** list; **Example:** SFT-U0-1S02A5P

# Fern

## Task Chair with Fixed Arms — Aluminum Base Model



SFT-U0-1S01A

### Dimensions

- \*SH: 16.5"-21.5"  
(419mm-546mm)
- H: 41.5"-47"  
(1054mm-1194mm)
- D: 28.5"(724mm)
- W: 29"(737mm)
- \*SW: 19.9"(505mm)
- \*AH: 9"(229mm)
- \*SD: 15.5"-18.5"  
(394mm-470mm)

Low position seat height:  
15"-17.5"(381mm-445mm)

\* All measurements taken with the BIFMA chair measuring device.

### Features

- Back: Flexible back with built in fronds wrapped in lofted mesh, knit or faux leather.
- Seat: Flexible seat pan with standard upholstered foam.
- Standard fixed seat. Optional seat depth adjustment (3"(76mm) range).
- Base: Aluminum five-star base.
- Optional height adjustable lumbar support (4"(102mm) adjustment).
- Arms: Fixed with soft arm caps.
- Optional leather arm cap available when ordering a leather seat. Leather arm cap coordinates with leather seat selection.
- Optional headrest has an upholstered front with a plastic back. Headrest material and trim color are matched to the back.
- Mechanism: Synchronized 3-point tilt; standard tilt tension adjustment.
- Height Adjustment: Pneumatic or optional low position. Range: 15"-17.5"(381mm-445mm).
- Back Stop: 5 positions.
- Optional Forward Tilt (with Back Stop): 5° downward from initial position.
- Casters: Hard casters in black or two-tone grey; Soft casters black only.
- COM yardage / COL square footage: (Seat only) 0.71/8

### To Order, Specify:

1) Product number, including;

#### 1) Caster Option: Standard Base

- 1** Std. Base Hard Casters (Black)
- 2** Std. Base Soft Casters (Black), add **\$60.15** to list
- T** Std. Base Hard Two-Tone Casters (Grey)

#### Low Base

- 3** Low Base, Hard Casters (Black)
- 4** Low Base, Soft Casters (Black), add **\$60.15** to list

- 2) Fabric surface and color (seat).
- 3) Mesh, knit or faux leather color (back).
- 4) Plastic trim color (back frame/cradle). (Add **\$86.06** list for Snow TR-UFM for back frame/cradle/arm caps.)
- 5) Aluminum trim color (back and arm upright/mechanism/base). (Add **\$140.81** list for polished aluminum back upright and mechanism.)

1st Trim Color (Plastic)	Arm Cap/Levers	Lumbar Handle
TR-F Black	TR-F Black	TR-TF Pitch
TR-7 Fog	TR-7 Fog	TR-AR Argent
TR-UFM Snow	TR-7 Fog	TR-FS Snowfall
TR-UFM Snow w/2nd trim PM-P Polished Aluminum	TR-7 Fog	PM-P Polished Aluminum

### Specification Tip

- When Polished Aluminum trim is specified, lumbar handle will default to Polished Aluminum.

Description	Number	1	Fabric Grade								Leather Grade A	Leather Grade B
			A	B	C	D	E	F	G	H		
<b>Mesh Back, No Lumbar Adjustment</b>												
Back Stop w/Seat Depth Adjustment	SFT-U0-1S01A	■	\$2084.27	\$2137.46	\$2193.81	\$2221.96	\$2242.32	\$2292.40	\$2339.34	\$2462.93	\$2550.56	\$2772.76
Back Stop Forward Tilt w/Seat Depth Adjustment	SFT-U0-1S04A	■	2209.45	2262.64	2318.99	2347.14	2367.50	2417.58	2464.52	2588.11	2675.74	2897.94
<b>Knit Back, No Lumbar Adjustment</b>												
Back Stop w/Seat Depth Adjustment	SFT-UU-1S01A	■	\$2334.54	\$2387.73	\$2444.08	\$2472.23	\$2492.59	\$2542.67	\$2589.61	\$2713.20	\$2800.83	\$3023.03
Back Stop Forward Tilt w/Seat Depth Adjustment	SFT-UU-1S04A	■	2459.72	2512.91	2569.26	2597.41	2617.77	2667.85	2714.79	2838.38	2926.01	3148.21
<b>Mesh Back, Lumbar Adjustment</b>												
Back Stop w/Seat Depth Adjustment	SFT-U0-1S11A	■	\$2225.08	\$2278.27	\$2334.62	\$2362.77	\$2383.13	\$2433.21	\$2480.15	\$2603.74	\$2691.37	\$2913.57
Back Stop Forward Tilt w/Seat Depth Adjustment	SFT-U0-1S14A	■	2350.26	2403.45	2459.80	2487.95	2508.31	2558.39	2605.33	2728.92	2816.55	3038.75
<b>Knit Back, Lumbar Adjustment</b>												
Back Stop w/Seat Depth Adjustment	SFT-UU-1S11A	■	\$2475.35	\$2528.54	\$2584.89	\$2613.04	\$2633.40	\$2683.48	\$2730.42	\$2854.01	\$2941.64	\$3163.84
Back Stop Forward Tilt w/Seat Depth Adjustment	SFT-UU-1S14A	■	2600.53	2653.72	2710.07	2738.22	2758.58	2808.66	2855.60	2979.19	3066.82	3289.02

The following options require modification of the product number.

- Fixed seat To specify, change the 10th digit from an **A** to **F**; **Example:** SFT-U0-1S01F1
- Leather arm cap To specify, change the 7th digit from **S** to **L**; **Example:** SFT-U0-1L01A1 (matches required Leather seat), add **\$109.54** list
- Faux Leather back To specify, change the fifth digit in the product number to **U**; **Example:** SFT-UU-1S01A1 (Wellington; add **\$179.95** list, Brisa; add **\$464.73** list)
- Headrest To specify, change the third digit from a **T** to an **E**; **Example:** SFE-U0-1S01A1 (Mesh; add **\$210.63** list, Faux Leather; add **\$273.21** list)
- Stain repellent (Seat only) To specify, add **P** to the end of the product number and add **\$54.77** list; **Example:** SFT-U0-1S01A1P

# Fern

## Task Chair without Arms — Plastic Base Model



SFT-U0-0N01A

1st Trim Color (Plastic)	Levers	Lumbar Handle
TR-F Black	TR-F Black	TR-TF Pitch
TR-7 Fog	TR-7 Fog	TR-AR Argent

### Dimensions

- \*SH: 16.5"-21.5" (419mm-546mm)
- H: 41.5"-47" (1054mm-1194mm)
- D: 28.5"(724mm)
- W: 29"(737mm)
- \*SW: 19.9"(505mm)
- \*SD: 15.5"-18.5" (394mm-470mm)

\* All measurements taken with the BIFMA chair measuring device.

### Features

- Back: Flexible back with built in fronds wrapped in lofted mesh, knit or faux leather.
- Seat: Flexible seat pan with standard upholstered foam.
- Standard fixed seat. Optional seat depth adjustment (3"(76mm) range).
- Base: Plastic five-star base. Available in Black or Fog.
- Optional height adjustable lumbar support (4"(102mm) adjustment).
- Optional headrest has an upholstered front with a plastic back. Headrest material and trim color are matched to the back.
- Mechanism: Synchronized 3-point tilt; standard tilt tension adjustment.
- Height Adjustment: Pneumatic. Range: 16.5"-21.5"(419mm-546mm).
- Back Stop: 5 positions.
- Optional Forward Tilt (with Back Stop): 5° downward from initial position.
- Casters: Hard casters in black or two-tone grey; Soft casters black only.
- COM yardage / COL square footage: (Seat only) 0.71/8

### To Order, Specify:

- 1) Product number, including;
  - 1** **Caster Option:**
    - 5** Hard Casters (Black)
    - 6** Soft Casters (Black), add **\$60.15** to list
    - 7** Hard Two-Tone Casters (Grey)
- 2) Fabric surface and color (seat).
- 3) Mesh, knit or faux leather color (back).
- 4) Plastic trim color (back frame/cradle/base).
- 5) Aluminum trim color (back upright and mechanism). (Add **\$140.81** list for polished aluminum back upright and mechanism.)

### Specification Tip

- When Polished Aluminum trim is specified, lumbar handle will default to Polished Aluminum.

Description	Number	Fabric Grade								Leather Grade A	Leather Grade B
		A	B	C	D	E	F	G	H		
<b>Mesh Back, No Lumbar Adjustment</b>											
Back Stop w/Seat Depth Adjustment	SFT-U0-0N01A	\$1658.66	\$1711.85	\$1768.20	\$1796.35	\$1816.71	\$1866.79	\$1913.73	\$2037.32	\$2124.95	\$2347.15
Back Stop Forward Tilt w/Seat Depth Adjustment	SFT-U0-0N04A	1783.84	1837.03	1893.38	1921.53	1941.89	1991.97	2038.91	2162.50	2250.13	2472.33
<b>Knit Back, No Lumbar Adjustment</b>											
Back Stop w/Seat Depth Adjustment	SFT-UU-0N01A	\$1908.93	\$1962.12	\$2018.47	\$2046.62	\$2066.98	\$2117.06	\$2164.00	\$2287.59	\$2375.22	\$2597.42
Back Stop Forward Tilt w/Seat Depth Adjustment	SFT-UU-0N04A	2034.11	2087.30	2143.65	2171.80	2192.16	2242.24	2289.18	2412.77	2500.40	2722.60
<b>Mesh Back, Lumbar Adjustment</b>											
Back Stop w/Seat Depth Adjustment	SFT-U0-0N11A	\$1799.47	\$1852.66	\$1909.01	\$1937.16	\$1957.52	\$2007.60	\$2054.54	\$2178.13	\$2265.76	\$2487.96
Back Stop Forward Tilt w/Seat Depth Adjustment	SFT-U0-0N14A	1924.65	1977.84	2034.19	2062.34	2082.70	2132.78	2179.72	2303.31	2390.94	2613.14
<b>Knit Back, Lumbar Adjustment</b>											
Back Stop w/Seat Depth Adjustment	SFT-UU-0N11A	\$2049.74	\$2102.93	\$2159.28	\$2187.43	\$2207.79	\$2257.87	\$2304.81	\$2428.40	\$2516.03	\$2738.23
Back Stop Forward Tilt w/Seat Depth Adjustment	SFT-UU-0N14A	2174.92	2228.11	2284.46	2312.61	2332.97	2383.05	2429.99	2553.58	2641.21	2863.41

The following options require modification of the product number.

- Fixed seat To specify, change the 10th digit from an **A** to **F**; **Example:** SFT-U0-0N01**F5**
- Faux Leather back To specify, change the fifth digit in the product number to **U**; **Example:** SFT-UU-0N01**A5** (Wellington; add **\$179.95** list, Brisa; add **\$464.73** list)
- Headrest To specify, change the third digit from a **T** to an **E**; **Example:** SFE-U0-0N01**A5** (Mesh; add **\$210.63** list, Faux Leather; add **\$273.21** list)
- Stain repellent (Seat only) To specify, add **P** to the end of the product number and add **\$54.77** list; **Example:** SFT-U0-0N01**A5P**

# Fern

## Task Chair without Arms — Aluminum Base Model

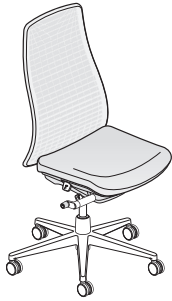

SFT-U0-0N01A

### Dimensions

- \*SH: 16.5"-21.5"  
(419mm-546mm)
- H: 41.5"-47"  
(1054mm-1194mm)
- D: 28.5"(724mm)
- W: 29"(737mm)
- \*SW: 19.9"(505mm)
- \*SD: 15.5"-18.5"  
(394mm-470mm)

Low position seat height:  
15"-17.5"(381mm-445mm)

\* All measurements taken with the BIFMA chair measuring device.

### Features

- Back: Flexible back with built in fronds wrapped in lofted mesh, knit or faux leather.
- Seat: Flexible seat pan with standard upholstered foam.
- Standard fixed seat. Optional seat depth adjustment (3"(76mm) range).
- Base: Aluminum five-star base.
- Optional height adjustable lumbar support (4"(102mm) adjustment).
- Optional headrest has an upholstered front with a plastic back. Headrest material and trim color are matched to the back.
- Mechanism: Synchronized 3-point tilt; standard tilt tension adjustment.
- Height Adjustment: Pneumatic or optional low position. Range: 15"-17.5"(381mm-445mm).
- Back Stop: 5 positions.
- Optional Forward Tilt (with Back Stop): 5° downward from initial position.
- Casters: Hard casters in black or two-tone grey; Soft casters black only.
- COM yardage / COL square footage: (Seat only) 0.71/8

### Specification Tip

- When Polished Aluminum trim is specified, lumbar handle will default to Polished Aluminum.

### To Order, Specify:

1) Product number, including;

#### 1) Caster Option: Standard Base

- 1** Std. Base Hard Casters (Black)
- 2** Std. Base Soft Casters (Black), add **\$60.15** to list
- T** Std. Base Hard Two-Tone Casters (Grey)

#### Low Base

- 3** Low Base, Hard Casters (Black)
- 4** Low Base, Soft Casters (Black), add **\$60.15** to list

- 2) Fabric surface and color (seat).
- 3) Mesh, knit or faux leather color (back).
- 4) Plastic trim color (back frame/cradle). (Add **\$86.06** list for Snow TR-UFM for back frame/cradle.)
- 5) Aluminum trim color (back upright/mechanism/base). (Add **\$140.81** list for polished aluminum back upright and mechanism.)

1st Trim Color (Plastic)	Levers	Lumbar Handle
TR-F Black	TR-F Black	TR-TF Pitch
TR-7 Fog	TR-7 Fog	TR-AR Argent
TR-UFM Snow	TR-7 Fog	TR-FS Snowfall
TR-UFM Snow w/2nd trim PM-P Polished Aluminum	TR-7 Fog	PM-P Polished Aluminum

Description	Number	Fabric Grade								Leather Grade A	Leather Grade B
		A	B	C	D	E	F	G	H		
<b>Mesh Back, No Lumbar Adjustment</b>											
Back Stop w/Seat Depth Adjustment	SFT-U0-0N01A	\$1896.50	\$1949.69	\$2006.04	\$2034.19	\$2054.55	\$2104.63	\$ 2151.57	\$2275.16	\$2362.79	\$2584.99
Back Stop Forward Tilt w/Seat Depth Adjustment	SFT-U0-0N04A	2021.68	2074.87	2131.22	2159.37	2179.73	2229.81	2276.75	2400.34	2487.97	2710.17
<b>Knit Back, No Lumbar Adjustment</b>											
Back Stop w/Seat Depth Adjustment	SFT-UU-0N01A	\$2146.77	\$2199.96	\$2256.31	\$2284.46	\$2304.82	\$2354.90	41796.54	\$2525.43	\$2613.06	\$2835.26
Back Stop Forward Tilt w/Seat Depth Adjustment	SFT-UU-0N04A	2271.95	2325.14	2381.49	2409.64	2430.00	2480.08	2527.02	2650.61	2738.24	2960.44
<b>Mesh Back, Lumbar Adjustment</b>											
Back Stop w/Seat Depth Adjustment	SFT-U0-0N11A	\$2037.31	\$2090.50	\$2146.85	\$2175.00	\$2195.36	\$2245.44	\$ 2292.38	\$2415.97	\$2503.60	\$2725.80
Back Stop Forward Tilt w/Seat Depth Adjustment	SFT-U0-0N14A	2162.49	2215.68	2272.03	2300.18	2320.54	2370.62	2417.56	2541.15	2628.78	2850.98
<b>Knit Back, Lumbar Adjustment</b>											
Back Stop w/Seat Depth Adjustment	SFT-UU-0N11A	\$2287.58	\$2340.77	\$2397.12	\$2425.27	\$2445.63	\$2495.71	\$ 2542.65	\$2666.24	\$2753.87	\$2976.07
Back Stop Forward Tilt w/Seat Depth Adjustment	SFT-UU-0N14A	2412.76	2465.95	2522.30	2550.45	2570.81	2620.89	2667.83	2791.42	2879.05	3101.25

The following options require modification of the product number.

- Fixed seat To specify, change the 10th digit from an **A** to **F**; **Example:** SFT-U0-0N01F1
- Faux Leather back To specify, change the fifth digit in the product number to **U**; **Example:** SFT-UU-0N01A1 (Wellington; add **\$179.95** list, Brisa; add **\$464.73** list)
- Headrest To specify, change the third digit from a **T** to an **E**; **Example:** SFE-U0-0N01A1 (Mesh; add **\$210.63** list, Faux Leather; add **\$273.21** list)
- Stain repellent (Seat only) To specify, add **P** to the end of the product number and add **\$54.77** list; **Example:** SFT-U0-0N01A1P

# Fern

## Task Stool with 4D Arms — Plastic Base Model



SFS-U0-7501A

1st Trim Color (Plastic)	Arm Cap/Levers	Lumbar Handle
TR-F Black	TR-F Black	TR-TF Pitch
TR-7 Fog	TR-7 Fog	TR-AR Argent

### Dimensions

- \*SH: 21.75"-29.25"  
(552mm-743mm)
- H: 46.75"-54.75"  
(1187mm-1391mm)
- D: 28.5"(724mm)
- W: 29"(737mm)
- \*SW: 19.9"(505mm)
- \*AH: 6.7"-11.5"  
(170mm-292mm)
- \*SD: 15.5"-18.5"  
(394mm-470mm)

\* All measurements taken with the BIFMA chair measuring device.

### Features

- Back: Flexible back with built in fronds wrapped in lofted mesh, knit or faux leather.
- Seat: Flexible seat pan with standard upholstered foam.
- Standard fixed seat. Optional seat depth adjustment (3"(76mm) range).
- Optional height adjustable lumbar support (4"(102mm) adjustment).
- Arms: 4D arms with plastic upright.
  - Move fore, aft, side to side and pivot in and out.
  - Height adjustment range of 4.8"(122mm).
- Arm Caps: Standard with soft arm caps.
- Mechanism: Synchronized 3-point tilt; standard tilt tension adjustment.
- Height Adjustment: Pneumatic. Range: 21.75"-29.25"(552mm-743mm).
- Back Stop: 5 positions.
- Base: Plastic five-star base.
- Footring: Adjusts 1.5"(38mm) up and down. Brushed aluminum finish.
- Casters: Hard casters in black or two-tone grey; Soft casters black only.
- COM yardage / COL square footage: (Seat only) 0.71/8

### To Order, Specify:

- 1) Product number, including;
  - 1** **Caster Option:**
    - 5** Hard Casters (Black)
    - 6** Soft Casters (Black), add **\$60.15** to list
    - 7** Hard Two-Tone Casters (Grey)
- 2) Fabric surface and color (seat).
- 3) Mesh, knit or faux leather color (back).
- 4) Plastic trim color for back frame/cradle/arm uprights/base.
- 5) Aluminum trim color for back upright and mechanism. (Add **\$140.81** list for polished aluminum back upright and mechanism.)

### Specification Tip

- When Polished Aluminum trim is specified, lumbar handle will default to Polished Aluminum.

Description	Number	①	Fabric Grade							Leather Grade A	Leather Grade B	
			A	B	C	D	E	F	G			H
<b>Mesh Back, No Lumbar Adjustment</b>												
Back Stop w/Seat Depth Adjustment	SFS-U0-7501A	■	\$2538.03	\$2591.22	\$2647.57	\$2675.72	\$2696.08	\$2746.16	\$2793.10	\$2916.69	\$3004.32	\$3226.52
<b>Knit Back, No Lumbar Adjustment</b>												
Back Stop w/Seat Depth Adjustment	SFS-UU-7501A	■	\$2788.30	\$2841.49	\$2897.84	\$2925.99	\$2946.35	\$2996.43	\$3043.37	\$3166.96	\$3254.59	\$3476.79
<b>Mesh Back, Lumbar Adjustment</b>												
Back Stop w/Seat Depth Adjustment	SFS-U0-7511A	■	\$2678.84	\$2732.03	\$2788.38	\$2816.53	\$2836.89	\$2886.97	\$2933.91	\$3057.50	\$3145.13	\$3367.33
<b>Knit Back, Lumbar Adjustment</b>												
Back Stop w/Seat Depth Adjustment	SFS-UU-7511A	■	\$2929.11	\$2982.30	\$3038.65	\$3066.80	\$3087.16	\$3137.24	\$3184.18	\$3307.77	\$3395.40	\$3617.60

The following options require modification of the product number.

- |                             |  |
|-----------------------------|--|
| Fixed seat                  | To specify, change the 10th digit from an <b>A</b> to <b>F</b> ; <b>Example:</b> SFS-U0-7501 <b>F5</b>   |
| Faux Leather back           | To specify, change the fifth digit in the product number to <b>U</b> ; <b>Example:</b> SFS-UU-7501A <b>5</b> (Wellington; add <b>\$179.95</b> list, Brisa; add <b>\$464.73</b> list) |
| Stain repellent (Seat only) | To specify, add <b>P</b> to the end of the product number and add <b>\$54.77</b> list; <b>Example:</b> SFS-U0-7501A <b>5P</b>  |

# Fern

## Task Stool with 4D Arms — Aluminum Base Model



SFS-U0-7S01A

### Dimensions

- \*SH: 21.75"-29.25"  
(552mm-743mm)
- H: 46.75"-54.75"  
(1187mm-1391mm)
- D: 28.5"(724mm)
- W: 29"(737mm)
- \*SW: 19.9"(505mm)
- \*AH: 6.7"-11.5"  
(170mm-292mm)
- \*SD: 15.5"-18.5"  
(394mm-470mm)

\* All measurements taken with the BIFMA chair measuring device.

### Features

- Back: Flexible back with built in fronds wrapped in lofted mesh, knit or faux leather.
- Seat: Flexible seat pan with standard upholstered foam.
- Standard fixed seat. Optional seat depth adjustment (3"(76mm) range).
- Optional height adjustable lumbar support (4"(102mm) adjustment).
- Arms: 4D arms with aluminum upright.
  - Move fore, aft, side to side and pivot in and out.
  - Height adjustment range of 4.8"(122mm).
- Arm Caps: Standard with soft arm caps.
- Mechanism: Synchronized 3-point tilt; standard tilt tension adjustment.
- Height Adjustment: Pneumatic. Range: 21.75"-29.25"(552mm-743mm).
- Back Stop: 5 positions.
- Base: Aluminum five-star base.
- Footring: Adjusts 1.5"(38mm) up and down. Brushed aluminum finish.
- Casters: Hard casters in black or two-tone grey; Soft casters black only.
- COM yardage / COL square footage: (Seat only) 0.71/8

### To Order, Specify:

1) Product number, including;

#### 1 Caster Option:

- 1** Hard Casters (Black)
- 2** Soft Casters (Black), add **\$60.15** to list
- T** Hard Two-Tone Casters (Grey)

- 2) Fabric surface and color (seat).
- 3) Mesh, knit or faux leather color (back).
- 4) Plastic trim color for back frame/cradle. (Add **\$86.06** list for Snow TR-UFM for back frame/cradle.)
- 5) Aluminum trim color for back and arm upright/mechanism/base. (Add **\$140.81** list for polished aluminum back upright and mechanism.)

1st Trim Color (Plastic)	Arm Cap/Levers	Lumbar Handle
TR-F Black	TR-F Black	TR-TF Pitch
TR-7 Fog	TR-7 Fog	TR-AR Argent
TR-UFM Snow	TR-7 Fog	TR-FS Snowfall
TR-UFM Snow w/2nd trim PM-P Polished Aluminum	TR-7 Fog	PM-P Polished Aluminum

### Specification Tip

- When Polished Aluminum trim is specified, lumbar handle will default to Polished Aluminum.

Description	Number	1	Fabric Grade							Leather Grade A	Leather Grade B	
			A	B	C	D	E	F	G			H
<b>Mesh Back, No Lumbar Adjustment</b>												
Back Stop w/Seat Depth Adjustment	SFS-U0-7S01A	■	\$2775.87	\$2829.06	\$2885.41	\$2913.56	\$2933.92	\$2984.00	\$3030.94	\$3154.53	\$3242.16	\$3464.36
<b>Knit Back, No Lumbar Adjustment</b>												
Back Stop w/Seat Depth Adjustment	SFS-UU-7S01A	■	\$3026.14	\$3079.33	\$3135.68	\$3163.83	\$3184.19	\$3234.27	\$3281.21	\$3404.80	\$3492.43	\$3714.63
<b>Mesh Back, Lumbar Adjustment</b>												
Back Stop w/Seat Depth Adjustment	SFS-U0-7S11A	■	\$2916.68	\$2969.87	\$3026.22	\$3054.37	\$3074.73	\$3124.81	\$3171.75	\$3295.34	\$3382.97	\$3605.17
<b>Knit Back, Lumbar Adjustment</b>												
Back Stop w/Seat Depth Adjustment	SFS-UU-7S11A	■	\$3166.95	\$3220.14	\$3276.49	\$3304.64	\$3325.00	\$3375.08	\$3422.02	\$3545.61	\$3633.24	\$3855.44

The following options require modification of the product number.

- Fixed seat To specify, change the 10th digit from an **A** to **F**; **Example:** SFS-U0-7S01**F1**
- Faux Leather back To specify, change the fifth digit in the product number to **U**; **Example:** SFS-UU-7S01**A1** (Wellington; add **\$179.95** list, Brisa; add **\$464.73** list)
- Stain repellent (Seat only) To specify, add **P** to the end of the product number and add **\$54.77** list; **Example:** SFS-U0-7S01**A1P**



# Fern

## Task Stool with Height Adjustable Arms — Plastic Base Model



SFS-U0-4S01A

1st Trim Color (Plastic)	Arm Cap/Levers	Lumbar Handle
TR-F Black	TR-F Black	TR-TF Pitch
TR-7 Fog	TR-7 Fog	TR-AR Argent

### Dimensions

- \*SH: 21.75"-29.25"  
(552mm-743mm)
- H: 46.75"-54.75"  
(1187mm-1391mm)
- D: 28.5"(724mm)
- W: 29"(737mm)
- \*SW: 19.9"(505mm)
- \*AH: 6.7"-11.5"  
(170mm-292mm)
- \*SD: 15.5"-18.5"  
(394mm-470mm)

\* All measurements taken with the BIFMA chair measuring device.

### Features

- Back: Flexible back with built in fronds wrapped in lofted mesh, knit or faux leather.
- Seat: Flexible seat pan with standard upholstered foam.
- Standard fixed seat. Optional seat depth adjustment (3"(76mm) range).
- Base: Plastic five-star base.
- Optional height adjustable lumbar support (4"(102mm) adjustment).
- Arms: Height Adjustable with soft arm caps. Adjustment range of 4.8"(122mm).
- Mechanism: Synchronized 3-point tilt; standard tilt tension adjustment.
- Height Adjustment: Pneumatic. Range: 21.75"-29.25"(552mm-743mm).
- Back Stop: 5 positions.
- Footring: Adjusts 1.5"(38mm) up and down. Brushed aluminum finish.
- Casters: Hard casters in black or two-tone grey; Soft casters black only.
- COM yardage / COL square footage: (Seat only) 0.71/8

### To Order, Specify:

- 1) Product number, including;
  - 1** **Caster Option:**
    - 5** Hard Casters (Black)
    - 6** Soft Casters (Black), add **\$60.15** to list
    - 7** Hard Two-Tone Casters (Grey)
- 2) Fabric surface and color (seat).
- 3) Mesh, knit or faux leather color (back).
- 4) Plastic trim color for back frame/cradle/arm uprights/base.
- 5) Aluminum trim color for back upright and mechanism. (Add **\$140.81** list for polished aluminum back upright and mechanism.)

### Specification Tip

- When Polished Aluminum trim is specified, lumbar handle will default to Polished Aluminum.

Description	Number	①	Fabric Grade							Leather Grade A	Leather Grade B	
			A	B	C	D	E	F	G			H
<b>Mesh Back, No Lumbar Adjustment</b>												
Back Stop w/Seat Depth Adjustment	SFS-U0-4S01A	■	\$2498.93	\$2552.12	\$2608.47	\$2636.62	\$2656.98	\$2707.06	\$2754.00	\$2877.59	\$2965.22	\$3187.42
<b>Knit Back, No Lumbar Adjustment</b>												
Back Stop w/Seat Depth Adjustment	SFS-UU-4S01A	■	\$2749.20	\$2802.39	\$2858.74	\$2886.89	\$2907.25	\$2957.33	\$3004.27	\$3127.86	\$3215.49	\$3437.69
<b>Mesh Back, Lumbar Adjustment</b>												
Back Stop w/Seat Depth Adjustment	SFS-U0-4S11A	■	\$2639.74	\$2692.93	\$2749.28	\$2777.43	\$2797.79	\$2847.87	\$2894.81	\$3018.40	\$3106.03	\$3328.23
<b>Knit Back, Lumbar Adjustment</b>												
Back Stop w/Seat Depth Adjustment	SFS-UU-4S11A	■	\$2890.01	\$2943.20	\$2999.55	\$3027.70	\$3048.06	\$3098.14	\$3145.08	\$3268.67	\$3356.30	\$3578.50

The following options require modification of the product number.

- Fixed seat To specify, change the 10th digit from an **A** to **F**; **Example:** SFS-U0-4S01F5
- Faux Leather back To specify, change the fifth digit in the product number to **U**; **Example:** SFS-UU-4S01A5 (Wellington; add **\$179.95** list, Brisa; add **\$464.73** list)
- Stain repellent (Seat only) To specify, add **P** to the end of the product number and add **\$54.77** list; **Example:** SFS-U0-4S01A5P

# Fern

## Task Stool with Height Adjustable Arms — Aluminum Base Model



SFS-U0-4S01A

### Dimensions

- \*SH: 21.75"-29.25"  
(552mm-743mm)
- H: 46.75"-54.75"  
(1187mm-1391mm)
- D: 28.5"(724mm)
- W: 29"(737mm)
- \*SW: 19.9"(505mm)
- \*AH: 6.7"-11.5"  
(170mm-292mm)
- \*SD: 15.5"-18.5"  
(394mm-470mm)

\* All measurements taken with the BIFMA chair measuring device.

### Features

- Back: Flexible back with built in fronds wrapped in lofted mesh, knit or faux leather.
- Seat: Flexible seat pan with standard upholstered foam.
- Standard fixed seat. Optional seat depth adjustment (3"(76mm) range).
- Optional height adjustable lumbar support (4"(102mm) adjustment).
- Arms: Height Adjustable with soft arm caps. Adjustment range of 4.8"(122mm).
- Mechanism: Synchronized 3-point tilt; standard tilt tension adjustment.
- Height Adjustment: Pneumatic. Range: 21.75"-29.25"(552mm-743mm).
- Back Stop: 5 positions.
- Base: Aluminum five-star base.
- Footring: Adjusts 1.5"(38mm) up and down. Brushed aluminum finish.
- Casters: Hard casters in black or two-tone grey; Soft casters black only.
- COM yardage / COL square footage: (Seat only) 0.71/8

### To Order, Specify:

1) Product number, including;

#### 1 Caster Option:

- 1** Hard Casters (Black)
- 2** Soft Casters (Black), add **\$60.15** to list
- T** Hard Two-Tone Casters (Grey)

- 2) Fabric surface and color (seat).
- 3) Mesh, knit or faux leather color (back).
- 4) Plastic trim color for back frame/cradle. (Add **\$86.06** list for Snow TR-UFM for back frame/cradle.)
- 5) Aluminum trim color for back and arm upright/mechanism/base. (Add **\$140.81** list for polished aluminum back upright and mechanism.)

1st Trim Color (Plastic)	Arm Cap/Levers	Lumbar Handle
TR-F Black	TR-F Black	TR-TF Pitch
TR-7 Fog	TR-7 Fog	TR-AR Argent
TR-UFM Snow	TR-7 Fog	TR-FS Snowfall
TR-UFM Snow w/2nd trim PM-P Polished Aluminum	TR-7 Fog	PM-P Polished Aluminum

### Specification Tip

- When Polished Aluminum trim is specified, lumbar handle will default to Polished Aluminum.

Description	Number	1	Fabric Grade							Leather Grade A	Leather Grade B	
			A	B	C	D	E	F	G			H
<b>Mesh Back, No Lumbar Adjustment</b>												
Back Stop w/Seat Depth Adjustment	SFS-U0-4S01A		\$2736.77	\$2789.96	\$2846.31	\$2874.46	\$2894.82	\$2944.90	\$2991.84	\$3115.43	\$3203.06	\$3425.26
<b>Knit Back, No Lumbar Adjustment</b>												
Back Stop w/Seat Depth Adjustment	SFS-UU-4S01A		\$2987.04	\$3040.23	\$3096.58	\$3124.73	\$3145.09	\$3195.17	\$3242.11	\$3365.70	\$3453.33	\$3675.53
<b>Mesh Back, Lumbar Adjustment</b>												
Back Stop w/Seat Depth Adjustment	SFS-U0-4S11A		\$2877.58	\$2930.77	\$2987.12	\$3015.27	\$3035.63	\$3085.71	\$3132.65	\$3256.24	\$3343.87	\$3566.07
<b>Knit Back, Lumbar Adjustment</b>												
Back Stop w/Seat Depth Adjustment	SFS-UU-4S11A		\$3127.85	\$3181.04	\$3237.39	\$3265.54	\$3285.90	\$3335.98	\$3382.92	\$3506.51	\$3594.14	\$3816.34

The following options require modification of the product number.

- Fixed seat To specify, change the 10th digit from an **A** to **F**; **Example:** SFS-U0-4S01F1
- Faux Leather back To specify, change the fifth digit in the product number to **U**; **Example:** SFS-UU-4S01A1 (Wellington; add **\$179.95** list, Brisa; add **\$464.73** list)
- Stain repellent (Seat only) To specify, add **P** to the end of the product number and add **\$54.77** list; **Example:** SFS-U0-4S01A1P

# Fern

## Task Stool with Fixed Arms — Plastic Base Model



SFS-U0-1S01A

### Dimensions

- \*SH: 21.75"-29.25"  
(552mm-743mm)
- H: 46.75"-54.75"  
(1187mm-1391mm)
- D: 28.5"(724mm)
- W: 29"(737mm)
- \*SW: 19.9"(505mm)
- \*AH: 9"(229mm)
- \*SD: 15.5"-18.5"  
(394mm-470mm)

\* All measurements taken with the BIFMA chair measuring device.

### Features

- Back: Flexible back with built in fronds wrapped in lofted mesh, knit or faux leather.
- Seat: Flexible seat pan with standard upholstered foam.
- Standard fixed seat. Optional seat depth adjustment (3"(76mm) range).
- Optional height adjustable lumbar support (4"(102mm) adjustment).
- Arms: Fixed aluminum arms with soft arm caps.
- Optional leather arm cap available when ordering a leather seat. Leather arm cap coordinates with leather seat selection.
- Mechanism: Synchronized 3-point tilt; standard tilt tension adjustment.
- Height Adjustment: Pneumatic. Range: 21.75"-29.25"(552mm-743mm).
- Back Stop: 5 positions.
- Base: Plastic five-star base.
- Footring: Adjusts 1.5"(38mm) up and down. Brushed aluminum finish.
- Casters: Hard casters in black or two-tone grey; Soft casters black only.
- COM yardage / COL square footage: (Seat only) 0.71/8

### To Order, Specify:

1) Product number, including;

#### 1 Caster Option:

- 5 Hard Casters (Black)
- 6 Soft Casters (Black), add \$60.15 to list
- 7 Hard Two-Tone Casters (Grey)

- 2) Fabric surface and color (seat).
- 3) Mesh, knit or faux leather color (back).
- 4) Plastic trim color for back frame/cradle/base.
- 5) Aluminum trim color for back and arm upright/mechanism. (Add \$140.81 list for polished aluminum back upright and mechanism.)

1st Trim Color (Plastic)	Arm Cap/Levers	Lumbar Handle
TR-F Black	TR-F Black	TR-TF Pitch
TR-7 Fog	TR-7 Fog	TR-AR Argent

### Specification Tip

- When Polished Aluminum trim is specified, lumbar handle will default to Polished Aluminum.

Description	Number	1	Fabric Grade								Leather Grade A	Leather Grade B
			A	B	C	D	E	F	G	H		
<b>Mesh Back, No Lumbar Adjustment</b>												
Back Stop w/Seat Depth Adjustment	SFS-U0-1S01A		\$2475.45	\$2528.64	\$2584.99	\$2613.14	\$2633.50	\$2683.58	\$2730.52	\$2854.11	\$2941.74	\$3163.94
<b>Knit Back, No Lumbar Adjustment</b>												
Back Stop w/Seat Depth Adjustment	SFS-UU-1S01A		\$2725.72	\$2778.91	\$2835.26	\$2863.41	\$2883.77	\$2933.85	\$2980.79	\$3104.38	\$3192.01	\$3414.21
<b>Mesh Back, Lumbar Adjustment</b>												
Back Stop w/Seat Depth Adjustment	SFS-U0-1S11A		\$2616.26	\$2669.45	\$2725.80	\$2753.95	\$2774.31	\$2824.39	\$2871.33	\$2994.92	\$3082.55	\$3304.75
<b>Knit Back, Lumbar Adjustment</b>												
Back Stop w/Seat Depth Adjustment	SFS-UU-1S11A		\$2866.53	\$2919.72	\$2976.07	\$3004.22	\$3024.58	\$3074.66	\$3121.60	\$3245.19	\$3332.82	\$3555.02

The following options require modification of the product number.

- |                             |  |
|-----------------------------|--|
| Fixed seat                  | To specify, change the 10th digit from an <b>A</b> to <b>F</b> ; <b>Example:</b> SFS-U0-1S01 <b>F5</b>   |
| Leather arm cap             | To specify, change the 7th digit from <b>S</b> to <b>L</b> ; <b>Example:</b> SFS-U0-1 <b>L</b> 01A5 (matches required Leather seat), add \$109.54 list         |
| Faux Leather back           | To specify, change the fifth digit in the product number to <b>U</b> ; <b>Example:</b> SFS-UU-1S01A5 (Wellington; add \$179.95 list, Brisa; add \$464.73 list) |
| Stain repellent (Seat only) | To specify, add <b>P</b> to the end of the product number and add \$54.77 list; <b>Example:</b> SFS-U0-1S01A5 <b>P</b>   |

# Fern

## Task Stool with Fixed Arms — Aluminum Base Model



SFS-U0-1S01A

### Dimensions

- \*SH: 21.75"-29.25"  
(552mm-743mm)
- H: 46.75"-54.75"  
(1187mm-1391mm)
- D: 28.5"(724mm)
- W: 29"(737mm)
- \*SW: 19.9"(505mm)
- \*AH: 9"(229mm)
- \*SD: 15.5"-18.5"  
(394mm-470mm)

\* All measurements taken with the BIFMA chair measuring device.

### Features

- Back: Flexible back with built in fronds wrapped in lofted mesh, knit or faux leather.
- Seat: Flexible seat pan with standard upholstered foam.
- Standard fixed seat. Optional seat depth adjustment (3"(76mm) range).
- Optional height adjustable lumbar support (4"(102mm) adjustment).
- Arms: Fixed with soft arm caps.
- Optional leather arm cap available when ordering a leather seat. Leather arm cap coordinates with leather seat selection.
- Mechanism: Synchronized 3-point tilt; standard tilt tension adjustment.
- Height Adjustment: Pneumatic. Range: 21.75"-29.25"(552mm-743mm).
- Back Stop: 5 positions.
- Base: Aluminum five-star base.
- Footring: Adjusts 1.5"(38mm) up and down. Brushed aluminum finish.
- Casters: Hard casters in black or two-tone grey; Soft casters black only.
- COM yardage / COL square footage: (Seat only) 0.71/8

### To Order, Specify:

1) Product number, including;

#### 1 Caster Option:

- 1** Hard Casters (Black)
- 2** Soft Casters (Black), add **\$60.15** to list
- T** Hard Two-Tone Casters (Grey)

- 2) Fabric surface and color (seat).
- 3) Mesh, knit or faux leather color (back).
- 4) Plastic trim color for base frame/cradle. (Add **\$86.06** list for Snow TR-UFM for back frame/cradle.)
- 5) Aluminum trim color for back and arm upright/mechanism/base. (Add **\$140.81** list for polished aluminum back upright and mechanism.)

1st Trim Color (Plastic)	Arm Cap/Levers	Lumbar Handle
TR-F Black	TR-F Black	TR-TF Pitch
TR-7 Fog	TR-7 Fog	TR-AR Argent
TR-UFM Snow	TR-7 Fog	TR-FS Snowfall
TR-UFM Snow w/2nd trim PM-P Polished Aluminum	TR-7 Fog	PM-P Polished Aluminum

### Specification Tip

- When Polished Aluminum trim is specified, lumbar handle will default to Polished Aluminum.

Description	Number	1	Fabric Grade							Leather Grade A	Leather Grade B	
			A	B	C	D	E	F	G			H
<b>Mesh Back, No Lumbar Adjustment</b>												
Back Stop w/Seat Depth Adjustment	SFS-U0-1S01A		\$2713.29	\$2766.48	\$2822.83	\$2850.98	\$2871.34	\$2921.42	\$2968.36	\$3091.95	\$3179.58	\$3401.78
<b>Knit Back, No Lumbar Adjustment</b>												
Back Stop w/Seat Depth Adjustment	SFS-UU-1S01A		\$2963.56	\$3016.75	\$3073.10	\$3101.25	\$3121.61	\$3171.69	\$3218.63	\$3342.22	\$3429.85	\$3652.05
<b>Mesh Back, Lumbar Adjustment</b>												
Back Stop w/Seat Depth Adjustment	SFS-U0-1S11A		\$2854.10	\$2907.29	\$2963.64	\$2991.79	\$3012.15	\$3062.23	\$3109.17	\$3232.76	\$3320.39	\$3542.59
<b>Knit Back, Lumbar Adjustment</b>												
Back Stop w/Seat Depth Adjustment	SFS-UU-1S11A		\$3104.37	\$3157.56	\$3213.91	\$3242.06	\$3262.42	\$3312.50	\$3359.44	\$3483.03	\$3570.66	\$3792.86

The following options require modification of the product number.

- Fixed seat To specify, change the 10th digit from an **A** to **F**; **Example:** SFS-U0-1S01F1
- Leather arm cap To specify, change the 7th digit from **S** to **L**; **Example:** SFS-U0-1L01A1 (matches required Leather seat), add **\$109.54** list
- Faux Leather back To specify, change the fifth digit in the product number to **U**; **Example:** SFS-UU-1S01A1 (Wellington; add **\$179.95** list, Brisa; add **\$464.73** list)
- Stain repellent (Seat only) To specify, add **P** to the end of the product number and add **\$54.77** list; **Example:** SFS-U0-1S01A1P

# Fern

## Task Stool without Arms — Plastic Base Model



SFS-U0-0N01A

1st Trim Color (Plastic)	Levers	Lumbar Handle
TR-F Black	TR-F Black	TR-TF Pitch
TR-7 Fog	TR-7 Fog	TR-AR Argent

### Dimensions

- \*SH: 21.75"-29.25"  
(552mm-743mm)
- H: 46.75"-54.75"  
(1187mm-1391mm)
- D: 28.5"(724mm)
- W: 29"(737mm)
- \*SW: 19.9"(505mm)
- \*SD: 15.5"-18.5"  
(394mm-470mm)

\* All measurements taken with the BIFMA chair measuring device.

### Features

- Back: Flexible back with built in fronds wrapped in lofted mesh, knit or faux leather.
- Seat: Flexible seat pan with standard upholstered foam.
- Standard fixed seat. Optional seat depth adjustment (3"(76mm) range).
- Optional height adjustable lumbar support (4"(102mm) adjustment).
- Mechanism: Synchronized 3-point tilt; standard tilt tension adjustment.
- Height Adjustment: Pneumatic. Range: 21.75"-29.25"(552mm-743mm).
- Back Stop: 5 positions.
- Footring: Adjusts 1.5"(38mm) up and down. Brushed aluminum finish.
- Casters: Hard casters in black or two-tone grey; Soft casters black only.
- COM yardage / COL square footage: (Seat only) 0.71/8

### To Order, Specify:

- 1) Product number, including;
  - 1** **Caster Option:**
    - 5** Hard Casters (Black)
    - 6** Soft Casters (Black), add **\$60.15** to list
    - 7** Hard Two-Tone Casters (Grey)
- 2) Fabric surface and color (seat).
- 3) Mesh, knit or faux leather color (back).
- 4) Plastic trim color for back frame/cradle/base.
- 5) Aluminum trim color for back upright and mechanism. (Add **\$140.81** list for polished aluminum back upright and mechanism.)

### Specification Tip

- When Polished Aluminum trim is specified, lumbar handle will default to Polished Aluminum.

Description	Number	1	Fabric Grade								Leather Grade A	Leather Grade B
			A	B	C	D	E	F	G	H		
<b>Mesh Back, No Lumbar Adjustment</b>												
Back Stop w/Seat Depth Adjustment	SFS-U0-0N01A		\$2287.68	\$2340.87	\$2397.22	\$2425.37	\$2445.73	\$2495.81	\$2542.75	\$2666.34	\$2753.97	\$2976.17
<b>Knit Back, No Lumbar Adjustment</b>												
Back Stop w/Seat Depth Adjustment	SFS-UU-0N01A		\$2537.95	\$2591.14	\$2647.49	\$2675.64	\$2696.00	\$2746.08	\$2793.02	\$2916.61	\$3004.24	\$3226.44
<b>Mesh Back, Lumbar Adjustment</b>												
Back Stop w/Seat Depth Adjustment	SFS-U0-0N11A		\$2428.49	\$2481.68	\$2538.03	\$2566.18	\$2586.54	\$2636.62	\$2683.56	\$2807.15	\$2894.78	\$3116.98
<b>Knit Back, Lumbar Adjustment</b>												
Back Stop w/Seat Depth Adjustment	SFS-UU-0N11A		\$2678.76	\$2731.95	\$2788.30	\$2816.45	\$2836.81	\$2886.89	\$2933.83	\$3057.42	\$3145.05	\$3367.25

The following options require modification of the product number.

- |                             |  |
|-----------------------------|--|
| Fixed seat                  | To specify, change the 10th digit from an <b>A</b> to <b>F</b> ; <b>Example:</b> SFS-U0-0N01 <b>F5</b>   |
| Faux Leather back           | To specify, change the fifth digit in the product number to <b>U</b> ; <b>Example:</b> SFS-UU-0N01 <b>A5</b> (Wellington; add <b>\$179.95</b> list, Brisa; add <b>\$464.73</b> list) |
| Stain repellent (Seat only) | To specify, add <b>P</b> to the end of the product number and add <b>\$54.77</b> list; <b>Example:</b> SFS-U0-0N01 <b>A5P</b>  |

# Fern

## Task Stool without Arms — Aluminum Base Model



SFS-U0-0N01A

### Dimensions

- \*SH: 21.75"-29.25"  
(552mm-743mm)
- H: 46.75"-54.75"  
(1187mm-1391mm)
- D: 28.5"(724mm)
- W: 29"(737mm)
- \*SW: 19.9"(505mm)
- \*SD: 15.5"-18.5"  
(394mm-470mm)

\* All measurements taken with the BIFMA chair measuring device.

### Features

- Back: Flexible back with built in fronds wrapped in lofted mesh, knit or faux leather.
- Seat: Flexible seat pan with standard upholstered foam.
- Standard fixed seat. Optional seat depth adjustment (3"(76mm) range).
- Optional height adjustable lumbar support (4"(102mm) adjustment).
- Mechanism: Synchronized 3-point tilt; standard tilt tension adjustment.
- Height Adjustment: Pneumatic. Range: 21.75"-29.25"(552mm-743mm).
- Back Stop: 5 positions.
- Base: Aluminum five-star base.
- Footring: Adjusts 1.5"(38mm) up and down. Brushed aluminum finish.
- Casters: Hard casters in black or two-tone grey; Soft casters black only.
- COM yardage / COL square footage: (Seat only) 0.71/8

### To Order, Specify:

1) Product number, including;

#### 1 Caster Option:

- 1 Hard Casters (Black)
- 2 Soft Casters (Black), add **\$60.15** to list
- T Hard Two-Tone Casters (Grey)

- 2) Fabric surface and color (seat).
- 3) Mesh, knit or faux leather color (back).
- 4) Plastic trim color for back frame/cradle. (Add **\$86.06** list for Snow TR-UFM for back frame/cradle.)
- 5) Aluminum trim color for back upright/mechanism/base. (Add **\$140.81** list for polished aluminum back upright and mechanism.)

1st Trim Color (Plastic)	Levers	Lumbar Handle
TR-F Black	TR-F Black	TR-TF Pitch
TR-7 Fog	TR-7 Fog	TR-AR Argent
TR-UFM Snow	TR-7 Fog	TR-FS Snowfall
TR-UFM Snow w/2nd trim PM-P Polished Aluminum	TR-7 Fog	PM-P Polished Aluminum

### Specification Tip

- When Polished Aluminum trim is specified, lumbar handle will default to Polished Aluminum.

Description	Number	Fabric Grade								Leather Grade A	Leather Grade B	
		1	A	B	C	D	E	F	G			H
<b>Mesh Back, No Lumbar Adjustment</b>												
Back Stop w/Seat Depth Adjustment	SFS-U0-0N01A		\$2525.52	\$2578.71	\$2635.06	\$2663.21	\$2683.57	\$2733.65	\$2780.59	\$2904.18	\$2991.81	\$3214.01
<b>Knit Back, No Lumbar Adjustment</b>												
Back Stop w/Seat Depth Adjustment	SFS-UU-0N01A		\$2775.79	\$2828.98	\$2885.33	\$2913.48	\$2933.84	\$2983.92	\$3030.86	\$3154.45	\$3242.08	\$3464.28
<b>Mesh Back, Lumbar Adjustment</b>												
Back Stop w/Seat Depth Adjustment	SFS-U0-0N11A		\$2666.33	\$2719.52	\$2775.87	\$2804.02	\$2824.38	\$2874.46	\$2921.40	\$3044.99	\$3132.62	\$3354.82
<b>Knit Back, Lumbar Adjustment</b>												
Back Stop w/Seat Depth Adjustment	SFS-UU-0N11A		\$2916.60	\$2969.79	\$3026.14	\$3054.29	\$3074.65	\$3124.73	\$3171.67	\$3295.26	\$3382.89	\$3605.09

The following options require modification of the product number.

- Fixed seat To specify, change the 10th digit from an **A** to **F**; **Example:** SFS-U0-0N01**F**1
- Faux Leather back To specify, change the fifth digit in the product number to **U**; **Example:** SFS-UU-0N01**A**1 (Wellington; add **\$179.95** list, Brisa; add **\$464.73** list)
- Stain repellent (Seat only) To specify, add **P** to the end of the product number and add **\$54.77** list; **Example:** SFS-U0-0N01**A**1**P**

# Zody II At-A-Glance

<b>Designer</b>	ITO Design and Haworth Design Studio
<b>Awards/Achievements</b>	<p>NeoCon Silver, Best of NeoCon, Seating: Ergonomic Desk/Task, June 2022, USA</p> <p>Metropolis Likes: Task Seating (winner) June 2022, USA</p> <p>Greenguard Gold</p> <p>Cradle to Cradle Certified Bronze</p>

**Zody II** A high-performing chair that blends science-based wellness and comfort with sustainability and international design.

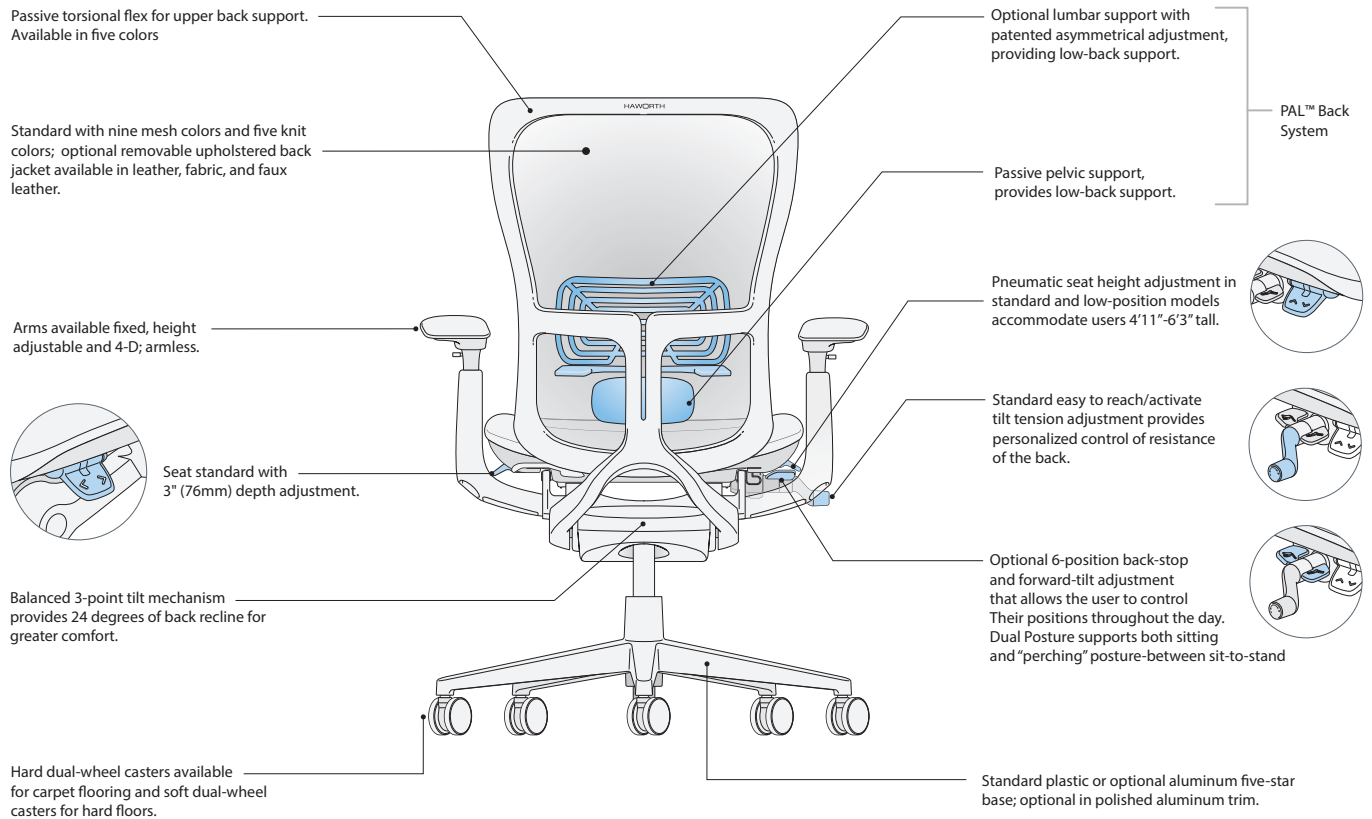

**Note:** Headrest and forward-tilt options available on task chair only.

# Zody II At-A-Glance

## General Guidelines for Product Specification

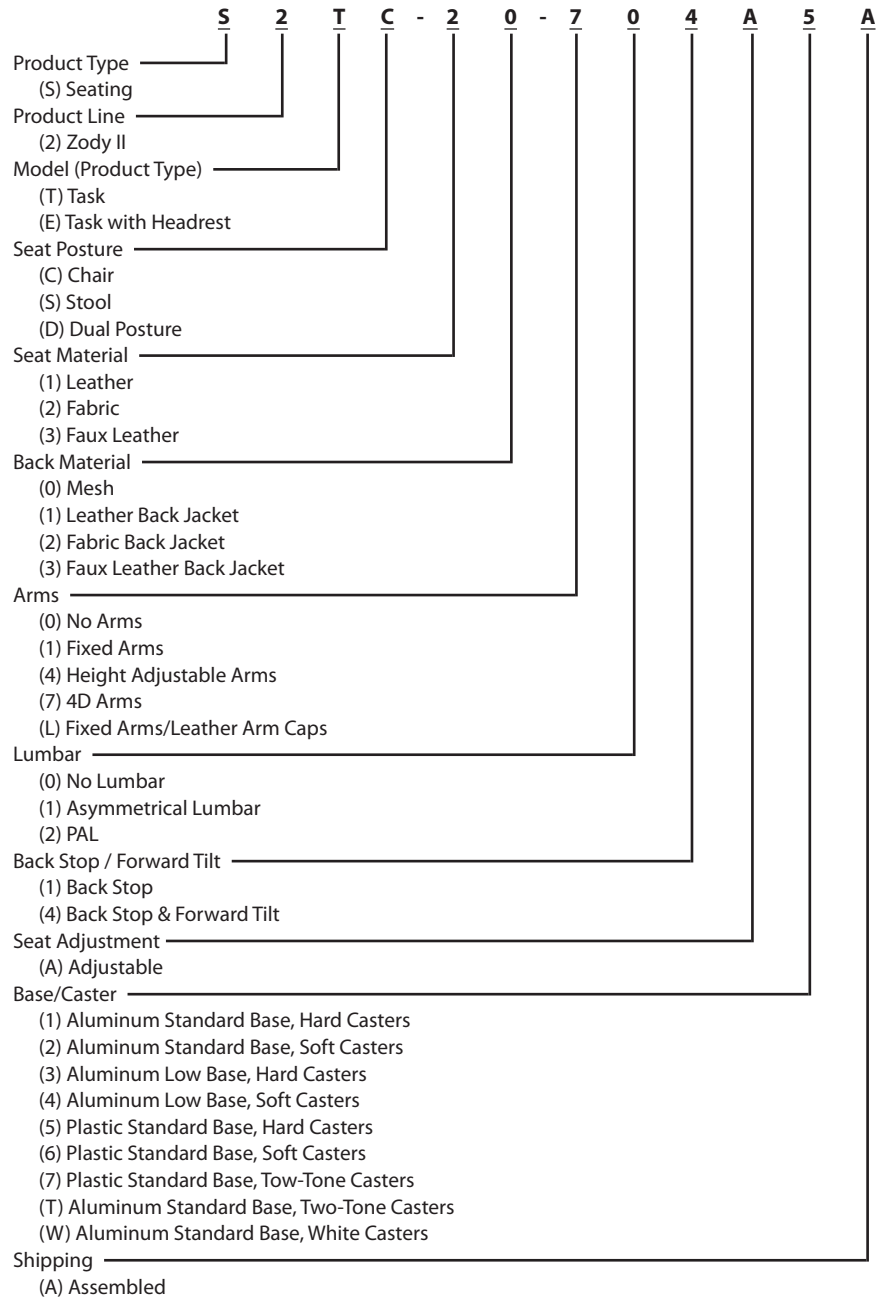



# Zody II At-A-Glance

## General Specifications

<b>Environmental Factors</b>	<ul style="list-style-type: none"> <li>• Zody II has been evaluated for its human health, environmental health, lifecycle attributes, renewable energy, water stewardship and social responsibility characteristics against stringent certification criteria and is considered an ecologically intelligent product.</li> <li>• Refer to Product Environmental Data sheet (PED) for recycled content and certifications.</li> <li>• Zody II is produced in an ISO 14001 certified manufacturing facility.</li> <li>• Components are identified with ISO recycling symbols and material information to assist in the recycling effort, where practical.</li> <li>• Haworth will take back Zody II chairs after their useful life and recycle the components. Please contact Haworth's Material Recovery Center at (616)393-1215.</li> </ul>
<b>COM &amp; COL General Information</b>	<p>To order a COM fabric (Customer's Own Material), contact the Haworth Inquiry Center (1.800.426.8562), your local Haworth dealer, or go to <a href="https://surfaces.haworth.com">surfaces.haworth.com</a> to find out if the COM you have selected has already been tested and approved. The surface collection site also has information on the Haworth alliance program with Carnegie, Luna Textiles, and Maharam as well as our industry-leading Pre-Approved COM program.</p> <p>COM fabrics are placed into Grades based on the cost per linear yard. If a fabric's cost exceeds the range of our highest Grade it will be noted as Non-Graded. The product will be priced at Grade A; the COM fabric costs will appear as a separate line item. The fabric charge will be Haworth's purchase cost plus a 4% administrative fee (based on the cost of the fabric). Yardage calculations will include any applicable fabric repeat.</p> <p>COM Leather products will be priced at a leather Grade A; COL costs will appear as a separate line item. The leather costs will be Haworth's purchase cost plus a 4% administrative fee (based on the cost of the leather).</p>
<b>Finishes and Fabrics</b>	For available finishes and fabrics please visit <a href="https://surfaces.haworth.com">surfaces.haworth.com</a>
<b>Stain Repellent</b>	<p>Stain Repellent or Stain Repellent with Moisture Barrier available on fabric surfaces only.</p> <p>Stain Repellent only: To specify add "<b>P</b>" to the end of the product number. Example: S2TC-20-714A5<b>AP</b></p> <p>Stain Repellent with Moisture Barrier: To specify add "<b>D</b>" to the end of the product number. Example: S2TC-20-714A5<b>AD</b></p>
<b>Shipping Weights (Including packaging)</b>	<ul style="list-style-type: none"> <li>• Chairs with arms: 55 pounds/1 chair per carton/19.4 cubic feet</li> <li>• Chairs without arms: 49 pounds/1 chair per carton/19.4 cubic feet</li> <li>• Dual Posture with arms: 57.6 pounds/1 chair per carton/22.1 cubic feet</li> <li>• Dual Posture without arms: 51.6 pounds/1 chair per carton/22.1 cubic feet</li> <li>• Stool with arms: 58 pounds/1 stool per carton/22.1 cubic feet</li> <li>• Stool without arms: 52 pounds/1 stool per carton/22.1 cubic feet</li> </ul>

# Zody II

## General Specifications

### STANDARD MOBILITY AND ADJUSTABILITY

#### Balanced 3-point tilt

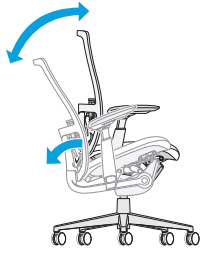

#### Features:

- Balanced 3-point tilt mechanism.
- Back reclines 24° from the upright position.
- Seat pan moves downward 3° from the initial position.

#### Benefits:

- Comfortable relaxed posture.
- Recline allows for the opening of the users' chest cavity providing good airflow to promote alertness.
- Users' feet remain flat.

#### Tilt Tension Control

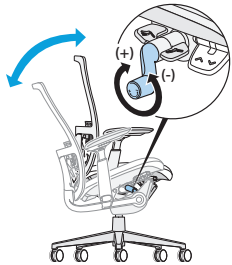

#### Feature:

- Easy-to-reach and easy-to-activate side-mounted tilt tension control regulates the amount of resistance felt when leaning back in the chair and the effort required to recline the chair backwards.

#### Benefit:

- Personalized support to accommodate users of different body types and different work styles.

#### Seat Height Adjustment

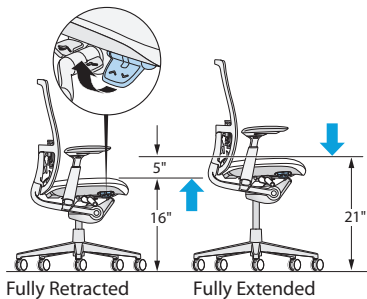

#### Features:

- Pneumatic seat height adjustment.
- Task chair seat height adjusts 5"(127mm) from 16" to 21"(406mm to 533mm) in standard models. Low-position adjusts 14.7" to 18"(373 to 457mm).
- Task stool seat height adjusts 7.3"(185mm) from 21" to 28.3"(533mm to 719mm).
- Dual Posture seat height adjusts 17.5" to 24.2"(445mm to 615mm).

#### Benefits:

- Ensures the comfort of the lower limbs by avoiding pressure on the underside of the thigh caused by a seat pan that is too high, or decreased thigh-to-torso angle if the seat pan is too low.
- Accommodates for users between approximately 4'11"(1499mm) and 6'3"(1905mm) tall to provide good leg circulation.
- Seat height adjustment also is important in setting the proper hand position and allowing for a proper sitting eye height.

#### Seat Depth Adjustment

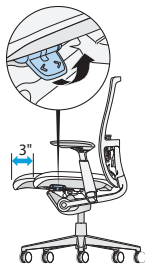

#### Features:

- 3"(76mm) of seat depth range.
- Waterfall edge.

#### Benefit:

- Supports the thighs, allows users to rest against the seat back for back support, and avoids pressure on the back of the knees of small to tall users.

#### Upper Back Torsional Movement



#### Feature:

- Passive 2"(51mm) of torsional flex in the upper back.
- Patented mesh with built in tension zones for added comfort.

#### Benefit:

- Increases users' mobility and comfort when reaching sideways for objects.

**Zody II**

## General Specifications

## OPTIONAL MOBILITY AND ADJUSTABILITY

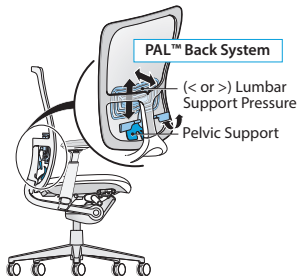
**PAL Back System****Features:**

- PAL Back System includes Asymmetrical Lumbar Adjustment and passive pelvic support.
- Asymmetrical Lumbar Adjustment adjusts 4”(102mm) in height; support level can be adjusted independently for right or left-hand side of users’ body.
- Passive pelvic support.

**Benefits:**

- Lumbar adjustment maintains the natural curvature of the spine at the lower back and allows users to choose the support that feels right for them.
- Passive pelvic support rotates the pelvis forward to maintain the natural spine shape.

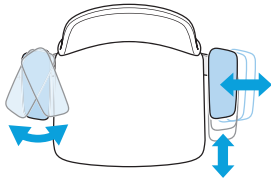
**4D Arm****Features:**

- Optional 4D arm.
- Arm adjusts in 4 ways:
  - Height adjustment: 4”(102mm)
  - Side-to-side arm cap adjustment range: 4”(102mm) [2”(51mm) each arm cap]
  - Front-to-back adjustment range: 2”(51mm)
  - Pivoting: In 20°; out 20°

**Benefits:**

- Arms support the muscular system of users’ neck and shoulders and proper arm support provides back relief. Arms can be an aid in standing or sitting down.
- Height adjustment accommodates for users with varying elbow rest heights so that users avoid lifting their shoulders or leaning sideways to get arm support.
- Front-to-back adjustment adjusts the armrest length, which is important because it allows users to get close to the worksurface while maintaining the effective use of the backrest.
- Side-to-side adjustment ensures a comfortable resting position for the arms with proper support of the forearm while allowing for easy entry/exit of the chair.
- Pivoting provides proper support of the forearm when performing tasks involving keying and mousing.

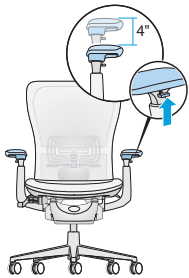
**Adjustable Height Arm****Feature:**

- Optional height adjustable arms adjust 4”(102mm) vertically.

**Benefit:**

- Height adjustment accommodates users with varying elbow rest heights so that users avoid lifting their shoulders or leaning sideways to get arm support.

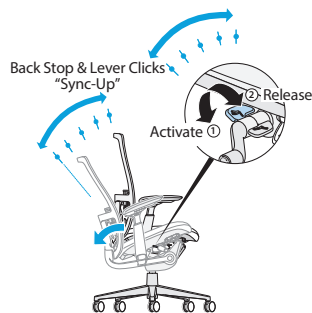
**Back Stop****Features:**

- Optional back stop;
- Back stops in 6 positions - upright and every 4° backward.

**Benefit:**

- Allows users the choice of selecting an upright position or limiting the amount of recline while performing different tasks.

# Zody II

## General Specifications

### OPTIONAL MOBILITY AND ADJUSTABILITY (continued)

#### Back Stop/Forward Tilt

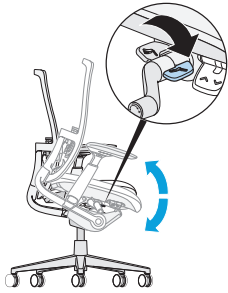

**Feature:**

- Optional back-stop and forward tilt.
- Back stops in 6 positions, upright and every 4° backward.
- Seat pan moves downward 5° from the initial position.

**Benefits:**

- Allows users to sit forward in the chair for task intensive work.
- Allows users to vary their posture for maximum comfort and for changes in task requirements.

**Note:** Not available on task stool.

#### Dual Posture

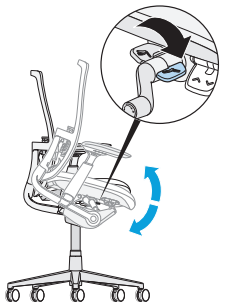

**Features:**

- Increased seat height range of 17.5”(445mm)-24.2”(615mm).
- Seat pan moves downward 5° from initial position with an increased degree of forward tilt.

**Benefit:**

- Promotes the in-between “perch” posture of sit-to-stand. Ideal for use with a height adjustable table.

#### Base

##### Standard Plastic Base

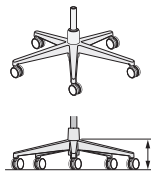

- TR-F Black
- TR-7 Fog

**Note:** When plastic base is specified all metal trim defaults to base color.

Hard casters in Black or Two-Tone Grey.  
Soft casters in Black.

##### Optional Aluminum Base

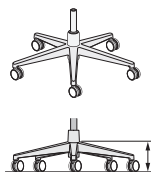

- TR-TF Pitch
- TR-LE Metallic Silver
- TR-MC Metallic Champagne
- TR-UFS Snowfall
- PM-P Polished Aluminum

Hard casters in Black, Two-Tone White or Two-Tone Grey.  
Soft casters in Black.

##### Low Position Base (Aluminum only)

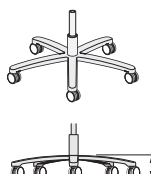

- TR-TF Pitch
- TR-LE Metallic Silver
- TR-MC Metallic Champagne
- TR-UFS Snowfall

**Note:** Low Position Base available on task chair only.

Hard or soft casters in Black.

#### Ergonomic Standards Guidelines

- All Zody II models meet or exceed all ANSI/BIFMA durability standards for office seating.
- Zody II meets the following ergonomic standards/guidelines:
  - BSR/HFES 100-2002
  - BIFMA G1-2002
  - CSA-Z412-2000
  - CAN/CGSB 44.232-2002
  - HFES 2007

# Zody II

General Specifications  
UPHOLSTERY / AESTHETIC OPTIONS

## Leather Upholstery



**Seat:** Stitched double seams. Vertically in the center and on the edges of the seat cushion.

**Back:** Vertical stitched double seams on the upholstered back jacket with leather or Customers Own Leather (COL).

## Upholstered Back Jacket

### Front View:

Leather Jacket



### Back View:



### Features

- Removable.
- Back jacket covers the inside back of the chairs allowing a back view of the mesh. Jacket consists of padding covered with fabric or leather upholstery.
- Available in fabric, faux leather, leather, COM and COL.

## Headrest



### Features

- Height-adjustable 2.5" to fit a wide range of users, headrest is TPU material, like Zody II arm.
- Trim color of headrest front and back are in same color. Black or Fog only. If a trim color other than Black or Fog is specified, the headrest will default to Black or Fog based on the matrix below.
- Headrest sent not attached; 10.5"W x 7.5"H, 2.5" height adjustment.
- See Zody II price pages for specification (available on all task seating models). Not available on stools or Dual Posture.

Specification Example: S2EC-20-714A5A

To add a headrest to an existing model in the field order service part: Back and Headrest replacement, see e-Parts.

## Specification

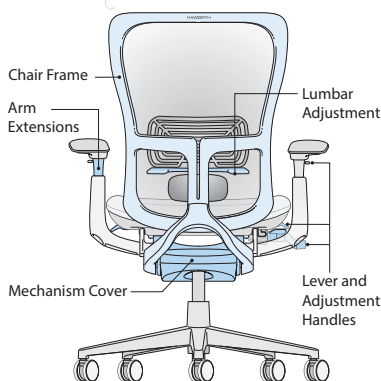

### Features

- Trim color specification applies to the following components:
  - Chair frame
  - Levers
  - Adjustment handles
  - Lumbar adjustment (not lumbar pad)
  - Arm extensions
  - Mechanism covers
- Arm cap and Headrest color defaults based on the matrix below.

Trim Color	Arm Cap & Headrest Color*	
	Black	Fog
Black (TR-F)	•	
Fog (TR-7)		•
Snow (TR-UFM)		•

\*Not specifiable.

# Zody II

## Task Chair



S2TC-20-0



S2TC-20-1



S2TC-20-4



S2TC-20-7

### Dimensions\*

- \*SH: 16"-21"(406mm-533mm)  
(Std. base)  
14.7"-18"(373-457mm)  
(Low base)
- H: 38"-43"(965mm-1092mm)  
(Std. base)  
36.7"-40"(932mm-1016mm)  
(Low base)
- D: 29"(737mm)
- W: 29"(737mm)
- \*SW: 19.5"(495mm)
- \*SD: 16.8"-19.5"(427mm-495mm)  
(with lumbar)  
17.5"-20.2"(445mm-513mm)  
(no lumbar)
- \*AH: 7.6"-11.6"(193mm-295mm)  
(Height Adjustable and 4D)  
8.5"(216mm) (Fixed)

\* Measurements taken with ISO chair measuring device.

### Features

- Back: Knit, mesh, or mesh back with upholstered back jacket.
- Seat: Upholstered with 3"(76mm) adjustable seat depth range.
- Base options:
  - Plastic standard five-star base.  
Casters: Hard casters in black or two-tone grey; Soft casters black only.
  - Aluminum standard five-star base.  
Casters: Hard casters in black, two-tone white or two-tone grey; Soft casters black only.
  - Aluminum low-position five-star base.  
Not available in PM-P Polished Aluminum.  
Casters: Hard or soft casters in black only.
  - Aluminum base available on chairs with arms only.  
Not available on armless chairs.
- Arm options:
  - No arms
  - Fixed arms; Optional leather arm caps available when leather seat is specified. Leather arm caps will match seat.
  - Height Adjustable; 4"(102mm) height adjustment range.
  - 4D; 4"(102mm) height adjustment, 4"(102mm) side-to-side range, 2"(51mm) front-to-back range and pivots 20° in and 20° out.
- Arm Cap will match plastic trim color (Black or Fog). When Snow is specified, arm cap will default to Fog.
- Height adjustment: Pneumatic or low-position pneumatic.
- Back Stop: Tilt stop in 6 positions.
- Back Stop/Forward Tilt; Tilt stop in 6 positions plus forward tilt 5° downward from initial position.
- Lumbar adjustment options:
  - No Lumbar
  - Asymmetrical Lumbar Adjustment: 4"(102mm) height adjustment; support level can be adjusted independently for right or left hand side of user's body.
  - PAL Back System: Asymmetrical lumbar adjustment with passive pelvic support.
- COM yardage / COL square footage:  
Upholstered back jacket: 0.75/10  
Seat: 0.75/10

**NOTE:** When specifying upholstered back jacket; must also specify mesh surface color for outside back.

Upcharge for mixed grade surfaces, refer to the electronic design and specification tools.

### To Order, Specify:

1) Product number, including:

#### 1 Seat Material

- 1 Leather
- 2 Fabric
- 3 Faux Leather

#### 2 Base/Caster Option:

##### Plastic Base

- 5 Plastic Base, Hard Caster
- 6 Plastic Base, Soft Caster, add **\$60.74** list
- 7 Plastic Base, Two-Tone Grey Caster, add **\$23.33** list

##### Aluminum Base

- 1 Aluminum Base, Hard Caster, add **\$104.97** list
- 2 Aluminum Base, Soft Caster, add **\$165.71** list
- T Aluminum Base, Two-Tone Grey Caster, add **\$128.30** list
- W Aluminum Base, White Caster, add **\$128.30** list

##### Low Base - Aluminum

- 3 Aluminum Low Base, Hard Caster, add **\$104.97** list
- 4 Aluminum Low Base, Soft Caster, add **\$174.95** list

- 2) Seat upholstery.
- 3) Back upholstery (Mesh or Knit).
- 4) Back jacket surface and color (if applicable).
- 5) Plastic trim color.<sup>1</sup>  
TR-F Black  
TR-7 Fog, add **\$104.97** list  
TR-UFM Snow,<sup>2</sup> add **\$174.95** list
- 6) Aluminum trim color.<sup>3</sup>  
TR-TF Pitch  
TR-LE Metallic Silver  
TR-MC Metallic Champagne  
TR-UFS Snowfall  
PM-P Polished Aluminum
- 7) Base trim color.  
*Plastic*  
TR-F Black  
TR-7 Fog, add **\$23.33** list  
*Aluminum*  
TR-TF Pitch  
TR-LE Metallic Silver  
TR-MC Metallic Champagne  
TR-UFS Snowfall, add **\$23.33** list  
PM-P Polished Aluminum, add **\$338.23** list

<sup>1</sup> Plastic trim color for back frame, arm caps, seat pan cover.

<sup>2</sup> When TR-UFM Snow trim is specified, arm cap and head rest will default to TR-7 Fog.

<sup>3</sup> Aluminum trim color for arm supports/uprights.

# Zody II

Task Chair

Plastic Base* Adjustments	Arm	Number		Fabric Grade								Leather Grade A	Leather Grade B	
		①	②	A	B	C	D	E	F	G	H			
<b>No Lumbar Adjustment - Mesh Back</b>														
Back Stop	No arm	S2TC-	0-001A	A	\$1142.97	\$1181.40	\$1222.36	\$1242.88	\$1258.23	\$1295.39	\$1328.67	\$1419.62	\$1708.15	\$1900.90
	Fixed	S2TC-	0-101A	A	1329.58	1368.01	1408.97	1429.49	1444.84	1482.00	1515.28	1606.23	1894.76	2087.51
	Height Adjustable	S2TC-	0-401A	A	1376.23	1414.66	1455.62	1476.14	1491.49	1528.65	1561.93	1652.88	1941.41	2134.16
	4D	S2TC-	0-701A	A	1415.88	1454.31	1495.27	1515.79	1531.14	1568.30	1601.58	1692.53	1981.06	2173.81
Back Stop/ Forward Tilt	No arm	S2TC-	0-004A	A	1266.60	1305.03	1345.99	1366.51	1381.86	1419.02	1452.30	1543.25	1831.78	2024.53
	Fixed	S2TC-	0-104A	A	1453.21	1491.64	1532.60	1553.12	1568.47	1605.63	1638.91	1729.86	2018.39	2211.14
	Height Adjustable	S2TC-	0-404A	A	1499.86	1538.29	1579.25	1599.77	1615.12	1652.28	1685.56	1776.51	2065.04	2257.79
	4D	S2TC-	0-704A	A	1539.51	1577.94	1618.90	1639.42	1654.77	1691.93	1725.21	1816.16	2104.69	2297.44
<b>No Lumbar Adjustment - Knit Back</b>														
Back Stop	No arm	S2TC-	0-001A	A	\$1296.92	\$1335.35	\$1376.31	\$1396.83	\$1412.18	\$1449.34	\$1482.62	\$1573.57	\$1862.10	\$2054.85
	Fixed	S2TC-	0-101A	A	1483.53	1521.96	1562.92	1583.44	1598.79	1635.95	1669.23	1760.18	2048.71	2241.46
	Height Adjustable	S2TC-	0-401A	A	1530.18	1568.61	1609.57	1630.09	1645.44	1682.60	1715.88	1806.83	2095.36	2288.11
	4D	S2TC-	0-701A	A	1569.83	1608.26	1649.22	1669.74	1685.09	1722.25	1755.53	1846.48	2135.01	2327.76
Back Stop/ Forward Tilt	No arm	S2TC-	0-004A	A	1420.55	1458.98	1499.94	1520.46	1535.81	1572.97	1606.25	1697.20	1985.73	2178.48
	Fixed	S2TC-	0-104A	A	1607.16	1645.59	1686.55	1707.07	1722.42	1759.58	1792.86	1883.81	2172.34	2365.09
	Height Adjustable	S2TC-	0-404A	A	1653.81	1692.24	1733.20	1753.72	1769.07	1806.23	1839.51	1930.46	2218.99	2411.74
	4D	S2TC-	0-704A	A	1693.46	1731.89	1772.85	1793.37	1808.72	1845.88	1879.16	1970.11	2258.64	2451.39
<b>No Lumbar Adjustment - Back Jacket</b>														
Back Stop	No arm	S2TC-	2-001A	A	\$1288.76	\$1365.07	\$1446.41	\$1487.14	\$1517.64	\$1591.43	\$1657.49	\$1838.10	\$2686.10	\$3153.77
	Fixed	S2TC-	2-101A	A	1475.37	1551.68	1633.02	1673.75	1704.25	1778.04	1844.10	2024.71	2872.71	3340.38
	Height Adjustable	S2TC-	2-401A	A	1522.02	1598.33	1679.67	1720.40	1750.90	1824.69	1890.75	2071.36	2919.36	3387.03
	4D	S2TC-	2-701A	A	1561.67	1637.98	1719.32	1760.05	1790.55	1864.34	1930.40	2111.01	2959.01	3426.68
Back Stop/ Forward Tilt	No arm	S2TC-	2-004A	A	1412.39	1488.70	1570.04	1610.77	1641.27	1715.06	1781.12	1961.73	2809.73	3277.40
	Fixed	S2TC-	2-104A	A	1599.00	1675.31	1756.65	1797.38	1827.88	1901.67	1967.73	2148.34	2996.34	3464.01
	Height Adjustable	S2TC-	2-404A	A	1645.65	1721.96	1803.30	1844.03	1874.53	1948.32	2014.38	2194.99	3042.99	3510.66
	4D	S2TC-	2-704A	A	1685.30	1761.61	1842.95	1883.68	1914.18	1987.97	2054.03	2234.64	3082.64	3550.31
<b>Asymmetrical Lumbar Adjustment - Mesh Back</b>														
Back Stop	No arm	S2TC-	0-011A	A	\$1256.10	\$1294.53	\$1335.49	\$1356.01	\$1371.36	\$1408.52	\$1441.80	\$1532.75	\$1821.28	\$2014.03
	Fixed	S2TC-	0-111A	A	1442.71	1481.14	1522.10	1542.62	1557.97	1595.13	1628.41	1719.36	2007.89	2200.64
	Height Adjustable	S2TC-	0-411A	A	1489.36	1527.79	1568.75	1589.27	1604.62	1641.78	1675.06	1766.01	2054.54	2247.29
	4D	S2TC-	0-711A	A	1529.01	1567.44	1608.40	1628.92	1644.27	1681.43	1714.71	1805.66	2094.19	2286.94
Back Stop/ Forward Tilt	No arm	S2TC-	0-014A	A	1379.73	1418.16	1459.12	1479.64	1494.99	1532.15	1565.43	1656.38	1944.91	2137.66
	Fixed	S2TC-	0-114A	A	1566.34	1604.77	1645.73	1666.25	1681.60	1718.76	1752.04	1842.99	2131.52	2324.27
	Height Adjustable	S2TC-	0-414A	A	1612.99	1651.42	1692.38	1712.90	1728.25	1765.41	1798.69	1889.64	2178.17	2370.92
	4D	S2TC-	0-714A	A	1652.64	1691.07	1732.03	1752.55	1767.90	1805.06	1838.34	1929.29	2217.82	2410.57
<b>Asymmetrical Lumbar Adjustment - Knit Back</b>														
Back Stop	No arm	S2TC-	0-011A	A	\$1410.05	\$1448.48	\$1489.44	\$1509.96	\$1525.31	\$1562.47	\$1595.75	\$1686.70	\$1975.23	\$2167.98
	Fixed	S2TC-	0-111A	A	1596.66	1635.09	1676.05	1696.57	1711.92	1749.08	1782.36	1873.31	2161.84	2354.59
	Height Adjustable	S2TC-	0-411A	A	1643.31	1681.74	1722.70	1743.22	1758.57	1795.73	1829.01	1919.96	2208.49	2401.24
	4D	S2TC-	0-711A	A	1682.96	1721.39	1762.35	1782.87	1798.22	1835.38	1868.66	1959.61	2248.14	2440.89
Back Stop/ Forward Tilt	No arm	S2TC-	0-014A	A	1533.68	1572.11	1613.07	1633.59	1648.94	1686.10	1719.38	1810.33	2098.86	2291.61
	Fixed	S2TC-	0-114A	A	1720.29	1758.72	1799.68	1820.20	1835.55	1872.71	1905.99	1996.94	2285.47	2478.22
	Height Adjustable	S2TC-	0-414A	A	1766.94	1805.37	1846.33	1866.85	1882.20	1919.36	1952.64	2043.59	2332.12	2524.87
	4D	S2TC-	0-714A	A	1806.59	1845.02	1885.98	1906.50	1921.85	1959.01	1992.29	2083.24	2371.77	2564.52

\* Pricing based on Plastic base with hard casters.

# Zody II

## Task Chair

Plastic Base* Adjustments	Arm	Number		Fabric Grade								Leather Grade A	Leather Grade B	
		①	②	A	B	C	D	E	F	G	H			
<b>Asymmetrical Lumbar Adjustment - Back Jacket</b>														
Back Stop	No arm	S2TC-	2-011A	A	\$1401.89	\$1478.20	\$1559.54	\$1600.27	\$1630.77	\$1704.56	\$1770.62	\$1951.23	\$2799.23	\$3266.90
	Fixed	S2TC-	2-111A	A	1588.50	1664.81	1746.15	1786.88	1817.38	1891.17	1957.23	2137.84	2985.84	3453.51
	Height Adjustable	S2TC-	2-411A	A	1635.15	1711.46	1792.80	1833.53	1864.03	1937.82	2003.88	2184.49	3032.49	3500.16
	4D	S2TC-	2-711A	A	1674.80	1751.11	1832.45	1873.18	1903.68	1977.47	2043.53	2224.14	3072.14	3539.81
Back Stop/ Forward Tilt	No arm	S2TC-	2-014A	A	1525.52	1601.83	1683.17	1723.90	1754.40	1828.19	1894.25	2074.86	2922.86	3390.53
	Fixed	S2TC-	2-114A	A	1712.13	1788.44	1869.78	1910.51	1941.01	2014.80	2080.86	2261.47	3109.47	3577.14
	Height Adjustable	S2TC-	2-414A	A	1758.78	1835.09	1916.43	1957.16	1987.66	2061.45	2127.51	2308.12	3156.12	3623.79
	4D	S2TC-	2-714A	A	1798.43	1874.74	1956.08	1996.81	2027.31	2101.10	2167.16	2347.77	3195.77	3663.44
<b>PAL Back System - Mesh Back</b>														
Back Stop	No arm	S2TC-	0-021A	A	\$1289.92	\$1328.35	\$1369.31	\$1389.83	\$1405.18	\$1442.34	\$1475.62	\$1566.57	\$1855.10	\$2047.85
	Fixed	S2TC-	0-121A	A	1476.53	1514.96	1555.92	1576.44	1591.79	1628.95	1662.23	1753.18	2041.71	2234.46
	Height Adjustable	S2TC-	0-421A	A	1523.18	1561.61	1602.57	1623.09	1638.44	1675.60	1708.88	1799.83	2088.36	2281.11
	4D	S2TC-	0-721A	A	1562.83	1601.26	1642.22	1662.74	1678.09	1715.25	1748.53	1839.48	2128.01	2320.76
Back Stop/ Forward Tilt	No arm	S2TC-	0-024A	A	1413.55	1451.98	1492.94	1513.46	1528.81	1565.97	1599.25	1690.20	1978.73	2171.48
	Fixed	S2TC-	0-124A	A	1600.16	1638.59	1679.55	1700.07	1715.42	1752.58	1785.86	1876.81	2165.34	2358.09
	Height Adjustable	S2TC-	0-424A	A	1646.81	1685.24	1726.20	1746.72	1762.07	1799.23	1832.51	1923.46	2211.99	2404.74
	4D	S2TC-	0-724A	A	1686.46	1724.89	1765.85	1786.37	1801.72	1838.88	1872.16	1963.11	2251.64	2444.39
<b>PAL Back System - Knit Back</b>														
Back Stop	No arm	S2TC-	0-021A	A	\$1443.87	\$1482.30	\$1523.26	\$1543.78	\$1559.13	\$1596.29	\$1629.57	\$1720.52	\$2009.05	\$2201.80
	Fixed	S2TC-	0-121A	A	1630.48	1668.91	1709.87	1730.39	1745.74	1782.90	1816.18	1907.13	2195.66	2388.41
	Height Adjustable	S2TC-	0-421A	A	1677.13	1715.56	1756.52	1777.04	1792.39	1829.55	1862.83	1953.78	2242.31	2435.06
	4D	S2TC-	0-721A	A	1716.78	1755.21	1796.17	1816.69	1832.04	1869.20	1902.48	1993.43	2281.96	2474.71
Back Stop/ Forward Tilt	No arm	S2TC-	0-024A	A	1567.50	1605.93	1646.89	1667.41	1682.76	1719.92	1753.20	1844.15	2132.68	2325.43
	Fixed	S2TC-	0-124A	A	1754.11	1792.54	1833.50	1854.02	1869.37	1906.53	1939.81	2030.76	2319.29	2512.04
	Height Adjustable	S2TC-	0-424A	A	1800.76	1839.19	1880.15	1900.67	1916.02	1953.18	1986.46	2077.41	2365.94	2558.69
	4D	S2TC-	0-724A	A	1840.41	1878.84	1919.80	1940.32	1955.67	1992.83	2026.11	2117.06	2405.59	2598.34
<b>PAL Back System - Back Jacket</b>														
Back Stop	No arm	S2TC-	2-021A	A	\$1435.71	\$1512.02	\$1593.36	\$1634.09	\$1664.59	\$1738.38	\$1804.44	\$1985.05	\$2833.05	\$3300.72
	Fixed	S2TC-	2-121A	A	1622.32	1698.63	1779.97	1820.70	1851.20	1924.99	1991.05	2171.66	3019.66	3487.33
	Height Adjustable	S2TC-	2-421A	A	1668.97	1745.28	1826.62	1867.35	1897.85	1971.64	2037.70	2218.31	3066.31	3533.98
	4D	S2TC-	2-721A	A	1708.62	1784.93	1866.27	1907.00	1937.50	2011.29	2077.35	2257.96	3105.96	3573.63
Back Stop/ Forward Tilt	No arm	S2TC-	2-024A	A	1559.34	1635.65	1716.99	1757.72	1788.22	1862.01	1928.07	2108.68	2956.68	3424.35
	Fixed	S2TC-	2-124A	A	1745.95	1822.26	1903.60	1944.33	1974.83	2048.62	2114.68	2295.29	3143.29	3610.96
	Height Adjustable	S2TC-	2-424A	A	1792.60	1868.91	1950.25	1990.98	2021.48	2095.27	2161.33	2341.94	3189.94	3657.61
	4D	S2TC-	2-724A	A	1832.25	1908.56	1989.90	2030.63	2061.13	2134.92	2200.98	2381.59	3229.59	3697.26

\* Pricing based on Plastic base with hard casters.

The following options require modification of the product number.

- Headrest
- Leather Arm Caps (Fixed arm only)
- Leather Seat and Back Jacket
- Faux Leather Seat and Back Jacket
- Stain Repellent

To specify, change the 3rd digit to an **E**; **Example:** S2EC-20-714A5A (add **\$75.81** list)  
 To specify, change the 7th digit to an **L**; **Example:** S2TC-10-L14A5A (add **\$303.24** list)  
**Note:** Leather arm caps available only when leather seat is specified. Arm cap will match seat.  
 To Specify, change the 6th digit to a **1**; **Example:** S2TC-11-714A5A  
 To Specify, change the 6th digit to a **3**; **Example:** S2TC-33-714A5A  
 To specify, add **P** to end of the product number; **Example:** S2TC-20-714A5AP (add **\$40.82** list)



# Zody II

## Stool



S2TS-20-0



S2TS-20-1



S2TS-20-4



S2TS-20-7

### Dimensions\*

- \*SH: 21"-28.3"(533mm-719mm)
- H: 43"-50.3"(1092mm-1278mm)
- D: 29"(737mm)
- W: 29"(737mm)
- \*SW: 19.5"(495mm)
- \*SD: 16.8"-19.5"(427mm-495mm) (with lumbar)
- 17.5"-20.2"(445mm-513mm) (no lumbar)
- \*AH: 7.6"-11.6"(193mm-295mm) (Height Adjustable and 4D)
- 8.5"(216mm) (Fixed)

\* Measurements taken with ISO chair measuring device.

### Features

- Back: Knit, mesh, or mesh back with upholstered back jacket.
- Seat: Upholstered with 3"(76mm) adjustable seat depth range.
- Base options:
  - Plastic standard five-star base. Casters: Hard casters in black or two-tone grey; Soft casters black only.
  - Aluminum standard five-star base. Casters: Hard casters in black, two-tone white or two-tone grey; Soft casters black only.
  - Aluminum base available on chairs with arms only. Not available on armless chairs.
- Arm options:
  - No arms
  - Fixed arms; Optional leather arm caps available when leather seat is specified. Leather arm caps will match seat.
  - Height Adjustable; 4"(102mm) height adjustment range.
  - 4D; 4"(102mm) height adjustment, 4"(102mm) side-to-side range, 2"(51mm) front-to-back range and pivots 20° in and 20° out.
- Arm Cap will match plastic trim color (Black or Fog). When Snow is specified, arm cap will default to Fog.
- Height adjustment: Pneumatic.
- Back Stop: Tilt stop in 6 positions.
- Lumbar adjustment options:
  - No Lumbar
  - Asymmetrical Lumbar Adjustment: 4"(102mm) height adjustment; support level can be adjusted independently for right or left hand side of user's body.
  - PAL Back System: Asymmetrical lumbar adjustment with passive pelvic support.
- COM yardage / COL square footage: Upholstered back jacket: 0.75/10  
Seat: 0.75/10

**NOTE:** When specifying upholstered back jacket; must also specify mesh surface color for outside back.

Upcharge for mixed grade surfaces, refer to the electronic design and specification tools.

### To Order, Specify:

1) Product number, including:

#### 1 Seat Material

- 1 Leather
- 2 Fabric
- 3 Faux Leather

#### 2 Base/Caster Option:

##### Plastic Base

- 5 Plastic Base, Hard Caster
- 6 Plastic Base, Soft Caster, add **\$60.74** list
- 7 Plastic Base, Two-Tone Grey Caster, add **\$23.33** list

##### Aluminum Base

- 1 Aluminum Base, Hard Caster, add **\$104.97** list
- 2 Aluminum Base, Soft Caster, add **\$165.71** list
- T Aluminum Base, Two-Tone Grey Caster, add **\$128.30** list
- W Aluminum Base, White Caster, add **\$128.30** list

- 2) Seat upholstery.
- 3) Back upholstery (Mesh or Knit).
- 4) Plastic trim color.<sup>1</sup>  
TR-F Black  
TR-7 Fog, add **\$104.97** list  
TR-UFM Snow,<sup>2</sup> add **\$174.95** list
- 5) Aluminum trim color.<sup>3</sup>  
TR-TF Pitch  
TR-LE Metallic Silver  
TR-MC Metallic Champagne  
TR-UFS Snowfall  
PM-P Polished Aluminum
- 6) Base trim color.  
*Plastic*  
TR-F Black  
TR-7 Fog, add **\$23.33** list  
*Aluminum*  
TR-TF Pitch  
TR-LE Metallic Silver  
TR-MC Metallic Champagne  
TR-UFS Snowfall, add **\$23.33** list  
PM-P Polished Aluminum, add **\$338.23** list

<sup>1</sup> Plastic trim color for back frame, arm caps, seat pan cover.

<sup>2</sup> When TR-UFM Snow trim is specified, arm cap will default to TR-7 Fog.

<sup>3</sup> Aluminum trim color for arm supports/uprights.

# Zody II

## Stool

Plastic Base* Adjustments	Arm	Number		Fabric Grade								Leather Grade A	Leather Grade B	
		①	②	A	B	C	D	E	F	G	H			
<b>No Lumbar Adjustment - Mesh Back</b>														
Back Stop	No arm	S2TS-	0-001A	A	\$1442.71	\$1481.14	\$1522.10	\$1542.62	\$1557.97	\$1595.13	\$1628.41	\$1719.36	\$2007.89	\$2200.64
	Fixed	S2TS-	0-101A	A	1629.32	1667.75	1708.71	1729.23	1744.58	1781.74	1815.02	1905.97	2194.50	2387.25
	Height Adjustable	S2TS-	0-401A	A	1675.97	1714.40	1755.36	1775.88	1791.23	1828.39	1861.67	1952.62	2241.15	2433.90
	4D	S2TS-	0-701A	A	1715.62	1754.05	1795.01	1815.53	1830.88	1868.04	1901.32	1992.27	2280.80	2473.55
<b>No Lumbar Adjustment - Knit Back</b>														
Back Stop	No arm	S2TS-	0-001A	A	\$1596.66	\$1635.09	\$1676.05	\$1696.57	\$1711.92	\$1749.08	\$1782.36	\$1873.31	\$2161.84	\$2354.59
	Fixed	S2TS-	0-101A	A	1783.27	1821.70	1862.66	1883.18	1898.53	1935.69	1968.97	2059.92	2348.45	2541.20
	Height Adjustable	S2TS-	0-401A	A	1829.92	1868.35	1909.31	1929.83	1945.18	1982.34	2015.62	2106.57	2395.10	2587.85
	4D	S2TS-	0-701A	A	1869.57	1908.00	1948.96	1969.48	1984.83	2021.99	2055.27	2146.22	2434.75	2627.50
<b>No Lumbar Adjustment - Back Jacket</b>														
Back Stop	No arm	S2TS-	2-001A	A	\$1588.50	\$1664.81	\$1746.15	\$1786.88	\$1817.38	\$1891.17	\$1957.23	\$2137.84	\$2985.84	\$3453.51
	Fixed	S2TS-	2-101A	A	1775.11	1851.42	1932.76	1973.49	2003.99	2077.78	2143.84	2324.45	3172.45	3640.12
	Height Adjustable	S2TS-	2-401A	A	1821.76	1898.07	1979.41	2020.14	2050.64	2124.43	2190.49	2371.10	3219.10	3686.77
	4D	S2TS-	2-701A	A	1861.41	1937.72	2019.06	2059.79	2090.29	2164.08	2230.14	2410.75	3258.75	3726.42
<b>Asymmetrical Lumbar Adjustment - Mesh Back</b>														
Back Stop	No arm	S2TS-	0-011A	A	\$1555.84	\$1594.27	\$1635.23	\$1655.75	\$1671.10	\$1708.26	\$1741.54	\$1832.49	\$2121.02	\$2313.77
	Fixed	S2TS-	0-111A	A	1742.45	1780.88	1821.84	1842.36	1857.71	1894.87	1928.15	2019.10	2307.63	2500.38
	Height Adjustable	S2TS-	0-411A	A	1789.10	1827.53	1868.49	1889.01	1904.36	1941.52	1974.80	2065.75	2354.28	2547.03
	4D	S2TS-	0-711A	A	1828.75	1867.18	1908.14	1928.66	1944.01	1981.17	2014.45	2105.40	2393.93	2586.68
<b>Asymmetrical Lumbar Adjustment - Knit Back</b>														
Back Stop	No arm	S2TS-	0-011A	A	\$1709.79	\$1748.22	\$1789.18	\$1809.70	\$1825.05	\$1862.21	\$1895.49	\$1986.44	\$2274.97	\$2467.72
	Fixed	S2TS-	0-111A	A	1896.40	1934.83	1975.79	1996.31	2011.66	2048.82	2082.10	2173.05	2461.58	2654.33
	Height Adjustable	S2TS-	0-411A	A	1943.05	1981.48	2022.44	2042.96	2058.31	2095.47	2128.75	2219.70	2508.23	2700.98
	4D	S2TS-	0-711A	A	1982.70	2021.13	2062.09	2082.61	2097.96	2135.12	2168.40	2259.35	2547.88	2740.63
<b>Asymmetrical Lumbar Adjustment - Back Jacket</b>														
Back Stop	No arm	S2TS-	2-011A	A	\$1701.63	\$1777.94	\$1859.28	\$1900.01	\$1930.51	\$2004.30	\$2070.36	\$2250.97	\$3098.97	\$3566.64
	Fixed	S2TS-	2-111A	A	1888.24	1964.55	2045.89	2086.62	2117.12	2190.91	2256.97	2437.58	3285.58	3753.25
	Height Adjustable	S2TS-	2-411A	A	1934.89	2011.20	2092.54	2133.27	2163.77	2237.56	2303.62	2484.23	3332.23	3799.90
	4D	S2TS-	2-711A	A	1974.54	2050.85	2132.19	2172.92	2203.42	2277.21	2343.27	2523.88	3371.88	3839.55
<b>PAL Back System - Mesh Back</b>														
Back Stop	No arm	S2TS-	0-021A	A	\$1589.66	\$1628.09	\$1669.05	\$1689.57	\$1704.92	\$1742.08	\$1775.36	\$1866.31	\$2154.84	\$2347.59
	Fixed	S2TS-	0-121A	A	1776.27	1814.70	1855.66	1876.18	1891.53	1928.69	1961.97	2052.92	2341.45	2534.20
	Height Adjustable	S2TS-	0-421A	A	1822.92	1861.35	1902.31	1922.83	1938.18	1975.34	2008.62	2099.57	2388.10	2580.85
	4D	S2TS-	0-721A	A	1862.57	1901.00	1941.96	1962.48	1977.83	2014.99	2048.27	2139.22	2427.75	2620.50
<b>PAL Back System - Knit Back</b>														
Back Stop	No arm	S2TS-	0-021A	A	\$1743.61	\$1782.04	\$1823.00	\$1843.52	\$1858.87	\$1896.03	\$1929.31	\$2020.26	\$2308.79	\$2501.54
	Fixed	S2TS-	0-121A	A	1930.22	1968.65	2009.61	2030.13	2045.48	2082.64	2115.92	2206.87	2495.40	2688.15
	Height Adjustable	S2TS-	0-421A	A	1976.87	2015.30	2056.26	2076.78	2092.13	2129.29	2162.57	2253.52	2542.05	2734.80
	4D	S2TS-	0-721A	A	2016.52	2054.95	2095.91	2116.43	2131.78	2168.94	2202.22	2293.17	2581.70	2774.45
<b>PAL Back System - Back Jacket</b>														
Back Stop	No arm	S2TS-	2-021A	A	\$1735.45	\$1811.76	\$1893.10	\$1933.83	\$1964.33	\$2038.12	\$2104.18	\$2284.79	\$3132.79	\$3600.46
	Fixed	S2TS-	2-121A	A	1922.06	1998.37	2079.71	2120.44	2150.94	2224.73	2290.79	2471.40	3319.40	3787.07
	Height Adjustable	S2TS-	2-421A	A	1968.71	2045.02	2126.36	2167.09	2197.59	2271.38	2337.44	2518.05	3366.05	3833.72
	4D	S2TS-	2-721A	A	2008.36	2084.67	2166.01	2206.74	2237.24	2311.03	2377.09	2557.70	3405.70	3873.37

\* Pricing based on Plastic base with hard casters.

The following options require modification of the product number.

Leather Arm Caps (Fixed arm only)

Leather Seat and Back Jacket  
Faux Leather Seat and Back Jacket  
Stain Repellent

To specify, change the 7th digit to an L; **Example:** S2TS-10-L14A5A (add \$303.24 list)

**Note:** Leather arm caps available only when leather seat is specified. Arm cap will match seat.

To Specify, change the 6th digit to a 1; **Example:** S2TS-11-714A5A

To Specify, change the 6th digit to a 3; **Example:** S2TS-33-714A5A

To specify, add P to end of the product number; **Example:** S2TS-20-714A5AP (add \$40.82 list)

**Zody II**

Dual Posture



S2TD-20-1



S2TD-20-4



S2TD-20-7

**Dimensions\***

- \*SH: 17.5"-24.2"(445mm-615mm)
- H: 39.5"-46.2"(1003mm-1173mm)
- D: 29"(737mm)
- W: 29"(737mm)
- \*SW: 19.5"(495mm)
- \*SD: 16.8"-19.5"(427mm-495mm)
- (with lumbar)
- 17.5"-20.2"(445mm-513mm)
- (no lumbar)
- \*AH: 7.6"-11.6"(193mm-295mm)
- (Height Adjustable and 4D)
- 8.5"(216mm) (Fixed)

\* Measurements taken with ISO chair measuring device.

**Features**

- Back: Knit, mesh, or mesh back with upholstered back jacket.
- Seat: Upholstered with 3"(76mm) adjustable seat depth range.
- Base options:
  - Aluminum standard five-star base.
  - Casters: Hard casters in black, two-tone white or two-tone grey; Soft casters black only.
- Arm options:
  - Fixed arms; Optional leather arm caps available when leather seat is specified. Leather arm caps will match seat.
  - Height Adjustable; 4"(102mm) height adjustment range.
  - 4D; 4"(102mm) height adjustment, 4"(102mm) side-to-side range, 2"(51mm) front-to-back range and pivots 20° in and 20° out.
- Arm Cap will match plastic trim color (Black or Fog). When Snow is specified, arm cap will default to Fog.
- Height adjustment: Pneumatic.
- Back Stop/Forward Tilt; Tilt stop in 6 positions plus forward tilt 5° downward from initial position.
- Lumbar adjustment options:
  - No Lumbar
  - Asymmetrical Lumbar Adjustment: 4"(102mm) height adjustment; support level can be adjusted independently for right or left hand side of user's body.
  - PAL Back System: Asymmetrical lumbar adjustment with passive pelvic support.
- COM yardage / COL square footage:
  - Upholstered back jacket: 0.75/10
  - Seat: 0.75/10

**NOTE:** When specifying upholstered back jacket; must also specify mesh surface color for outside back.

Upcharge for mixed grade surfaces, refer to the electronic design and specification tools.

**To Order, Specify:**

1) Product number, including:

**1 Seat Material**

- 1** Leather
- 2** Fabric
- 3** Faux Leather

**2 Base/Caster Option:****Aluminum Base**

- 1** Aluminum Base, Hard Caster
- 2** Aluminum Base, Soft Caster, add **\$60.74** list
- T** Aluminum Base, Two-Tone Grey Caster, add **\$23.33** list
- W** Aluminum Base, White Caster, add **\$23.33** list

- 2) Seat upholstery.
- 3) Back upholstery (Mesh or Knit).
- 4) Plastic trim color.<sup>1</sup>
  - TR-F Black
  - TR-7 Fog, add **\$104.97** list
  - TR-UFM Snow,<sup>2</sup> add **\$174.95** list
- 5) Aluminum trim color.<sup>3</sup>
  - TR-TF Pitch
  - TR-LE Metallic Silver
  - TR-MC Metallic Champagne
  - TR-UFS Snowfall
  - PM-P Polished Aluminum
- 6) Base trim color.
  - TR-TF Pitch
  - TR-LE Metallic Silver
  - TR-MC Metallic Champagne
  - TR-UFS Snowfall, add **\$23.33** list
  - PM-P Polished Aluminum, add **\$338.23** list

<sup>1</sup> Plastic trim color for back frame, arm caps, seat pan cover.

<sup>2</sup> When TR-UFM Snow trim is specified, arm cap will default to TR-7 Fog.

<sup>3</sup> Aluminum trim color for arm supports/uprights.

# Zody II

## Dual Posture

Adjustments	Arm	Number		Fabric Grade								Leather Grade A	Leather Grade B	
		①	②	A	B	C	D	E	F	G	H			
<b>No Lumbar Adjustment - Mesh Back</b>														
Back Stop/ Forward Tilt	Fixed	S2TD-	0-104A	A	\$1791.44	\$1829.87	\$1870.83	\$1891.35	\$1906.70	\$1943.86	\$1977.14	\$2068.09	\$2356.62	\$2549.37
	Height Adjustable	S2TD-	0-404A	A	1838.09	1876.52	1917.48	1938.00	1953.35	1990.51	2023.79	2114.74	2403.27	2596.02
	4D	S2TD-	0-704A	A	1877.74	1916.17	1957.13	1977.65	1993.00	2030.16	2063.44	2154.39	2442.92	2635.67
<b>No Lumbar Adjustment - Knit Back</b>														
Back Stop/ Forward Tilt	Fixed	S2TD-	0-104A	A	\$1945.39	\$1983.82	\$2024.78	\$2045.30	\$2060.65	\$2097.81	\$2131.09	\$2222.04	\$2510.57	\$2703.32
	Height Adjustable	S2TD-	0-404A	A	1992.04	2030.47	2071.43	2091.95	2107.30	2144.46	2177.74	2268.69	2557.22	2749.97
	4D	S2TD-	0-704A	A	2031.69	2070.12	2111.08	2131.60	2146.95	2184.11	2217.39	2308.34	2596.87	2789.62
<b>No Lumbar Adjustment - Back Jacket</b>														
Back Stop/ Forward Tilt	Fixed	S2TD-	2-104A	A	\$1937.23	\$2013.54	\$2094.88	\$2135.61	\$2166.11	\$2239.90	\$2305.96	\$2486.57	\$3334.57	\$3802.24
	Height Adjustable	S2TD-	2-404A	A	1983.88	2060.19	2141.53	2182.26	2212.76	2286.55	2352.61	2533.22	3381.22	3848.89
	4D	S2TD-	2-704A	A	2023.53	2099.84	2181.18	2221.91	2252.41	2326.20	2392.26	2572.87	3420.87	3888.54
<b>Asymmetrical Lumbar Adjustment - Mesh Back</b>														
Back Stop/ Forward Tilt	Fixed	S2TD-	0-114A	A	\$1904.57	\$1943.00	\$1983.96	\$2004.48	\$2019.83	\$2056.99	\$2090.27	\$2181.22	\$2469.75	\$2662.50
	Height Adjustable	S2TD-	0-414A	A	1951.22	1989.65	2030.61	2051.13	2066.48	2103.64	2136.92	2227.87	2516.40	2709.15
	4D	S2TD-	0-714A	A	1990.87	2029.30	2070.26	2090.78	2106.13	2143.29	2176.57	2267.52	2556.05	2748.80
<b>Asymmetrical Lumbar Adjustment - Knit Back</b>														
Back Stop/ Forward Tilt	Fixed	S2TD-	0-114A	A	\$2058.52	\$2096.95	\$2137.91	\$2158.43	\$2173.78	\$2210.94	\$2244.22	\$2335.17	\$2623.70	\$2816.45
	Height Adjustable	S2TD-	0-414A	A	2105.17	2143.60	2184.56	2205.08	2220.43	2257.59	2290.87	2381.82	2670.35	2863.10
	4D	S2TD-	0-714A	A	2144.82	2183.25	2224.21	2244.73	2260.08	2297.24	2330.52	2421.47	2710.00	2902.75
<b>Asymmetrical Lumbar Adjustment - Back Jacket</b>														
Back Stop/ Forward Tilt	Fixed	S2TD-	2-114A	A	\$2050.36	\$2126.67	\$2208.01	\$2248.74	\$2279.24	\$2353.03	\$2419.09	\$2599.70	\$3447.70	\$3915.37
	Height Adjustable	S2TD-	2-414A	A	2097.01	2173.32	2254.66	2295.39	2325.89	2399.68	2465.74	2646.35	3494.35	3962.02
	4D	S2TD-	2-714A	A	2136.66	2212.97	2294.31	2335.04	2365.54	2439.33	2505.39	2686.00	3534.00	4001.67
<b>PAL Back System - Mesh Back</b>														
Back Stop/ Forward Tilt	Fixed	S2TD-	0-124A	A	\$1938.39	\$1976.82	\$2017.78	\$2038.30	\$2053.65	\$2090.81	\$2124.09	\$2215.04	\$2503.57	\$2696.32
	Height Adjustable	S2TD-	0-424A	A	1985.04	2023.47	2064.43	2084.95	2100.30	2137.46	2170.74	2261.69	2550.22	2742.97
	4D	S2TD-	0-724A	A	2024.69	2063.12	2104.08	2124.60	2139.95	2177.11	2210.39	2301.34	2589.87	2782.62
<b>PAL Back System - Knit Back</b>														
Back Stop/ Forward Tilt	Fixed	S2TD-	0-124A	A	\$2092.34	\$2130.77	\$2171.73	\$2192.25	\$2207.60	\$2244.76	\$2278.04	\$2368.99	\$2657.52	\$2850.27
	Height Adjustable	S2TD-	0-424A	A	2138.99	2177.42	2218.38	2238.90	2254.25	2291.41	2324.69	2415.64	2704.17	2896.92
	4D	S2TD-	0-724A	A	2178.64	2217.07	2258.03	2278.55	2293.90	2331.06	2364.34	2455.29	2743.82	2936.57
<b>PAL Back System - Back Jacket</b>														
Back Stop/ Forward Tilt	Fixed	S2TD-	2-124A	A	\$2084.18	\$2160.49	\$2241.83	\$2282.56	\$2313.06	\$2386.85	\$2452.91	\$2633.52	\$3481.52	\$3949.19
	Height Adjustable	S2TD-	2-424A	A	2130.83	2207.14	2288.48	2329.21	2359.71	2433.50	2499.56	2680.17	3528.17	3995.84
	4D	S2TD-	2-724A	A	2170.48	2246.79	2328.13	2368.86	2399.36	2473.15	2539.21	2719.82	3567.82	4035.49

The following options require modification of the product number.

Leather Arm Caps (Fixed arm only)

To specify, change the 7th digit to an L; **Example:** S2TD-10-L14A1A (add **\$303.24** list)

**Note:** Leather arm caps available only when leather seat is specified. Arm cap will match seat.

Leather Seat and Back Jacket

To Specify, change the 6th digit to a 1; **Example:** S2TD-11-714A1A

Faux Leather Seat and Back Jacket

To Specify, change the 6th digit to a 3; **Example:** S2TD-33-714A1A

Stain Repellent

To specify, add P to end of the product number; **Example:** S2TD-20-714A1AP (add **\$40.82** list)

# Zody LX At-A-Glance

<b>Designer</b>	ITO Design and Haworth Design Studio
<b>Awards/Achievements</b>	<p>NeoCon Silver, Best of NeoCon, Seating: Ergonomic Desk/Task, June 2022, USA</p> <p>Metropolis Likes: Task Seating (winner) June 2022, USA</p> <p>Greenguard Gold</p> <p>Cradle to Cradle Certified Bronze</p>

**Zody LX** A high-performing chair that blends science-based wellness and comfort with sustainability and international design.

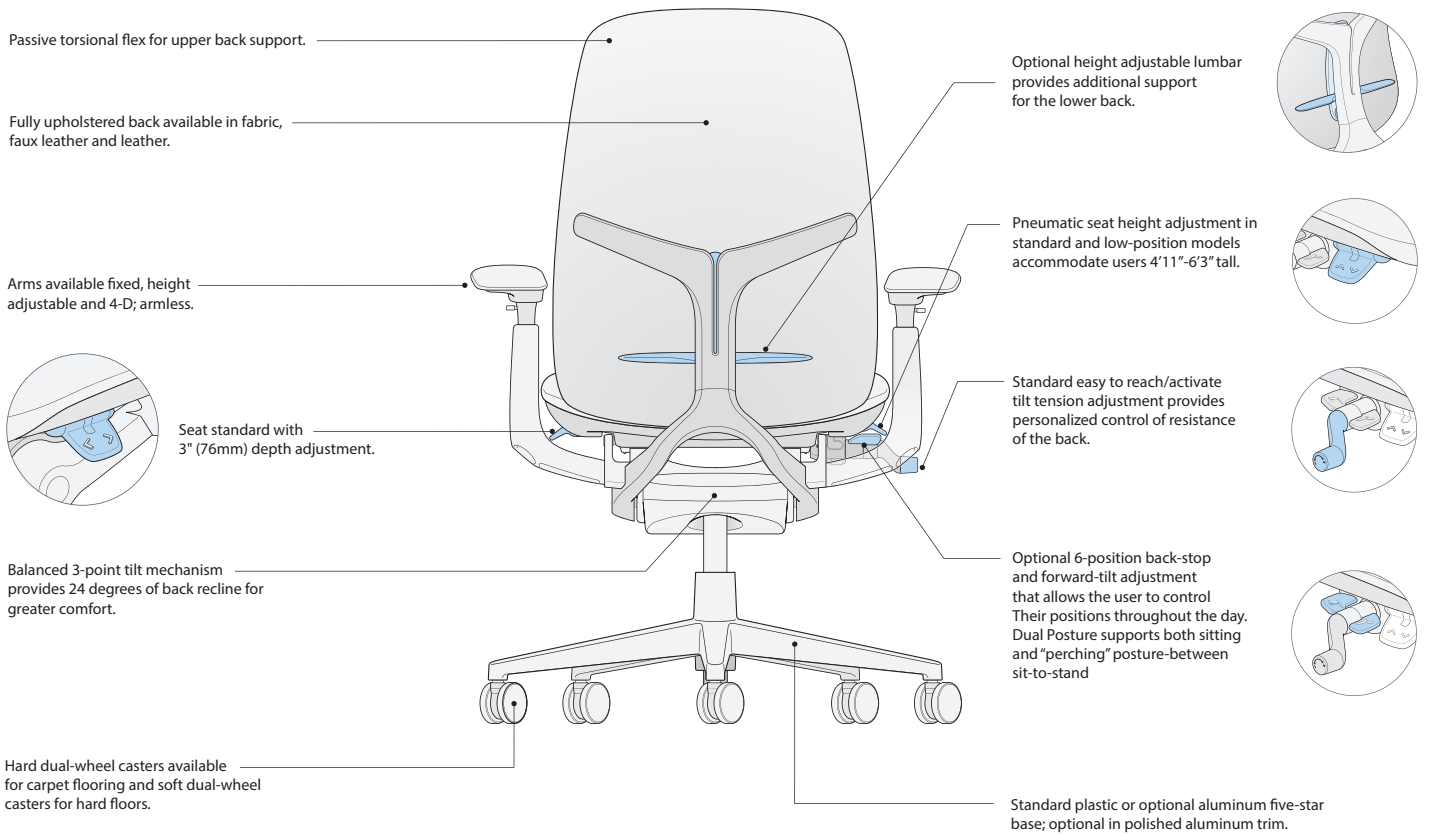

**Note:** Forward-tilt option not available on Stool.

# Zody LX At-A-Glance

## General Guidelines for Product Specification

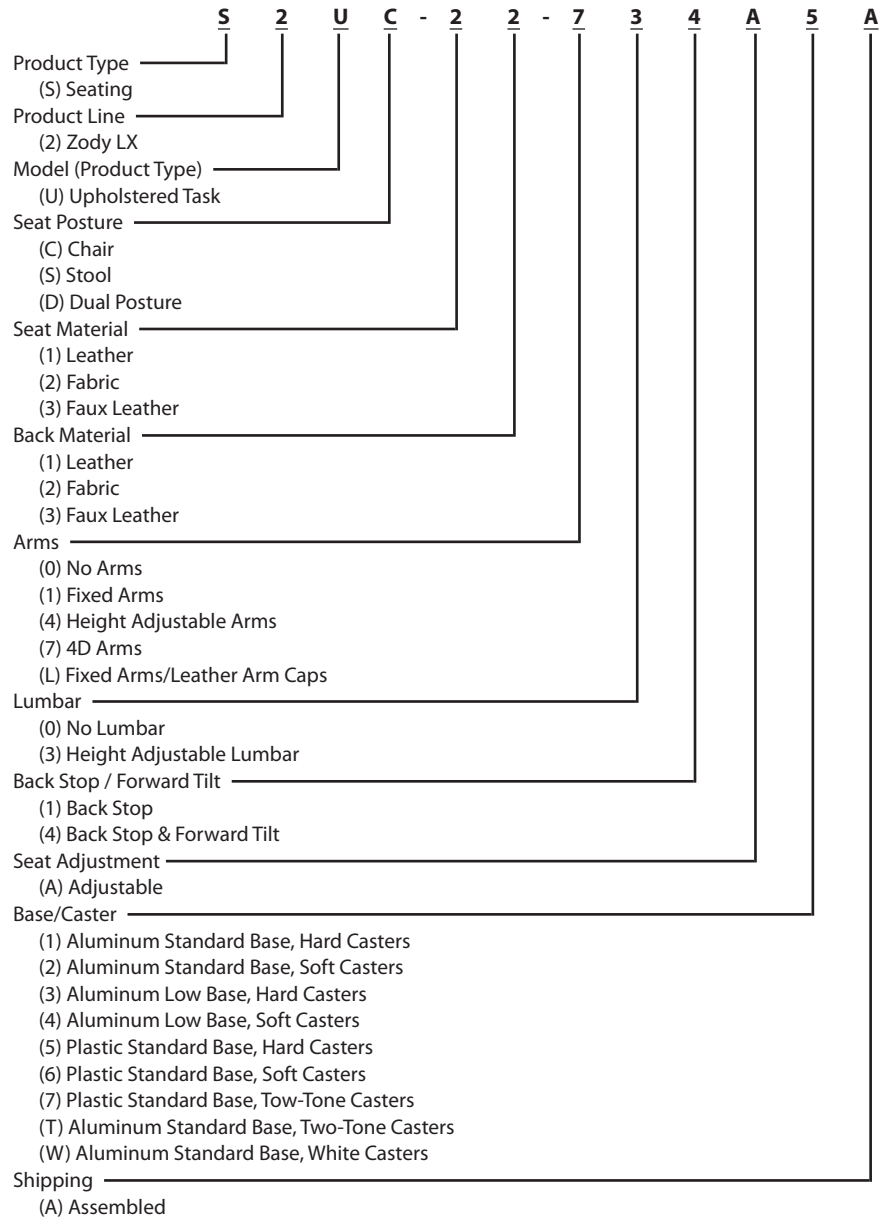

# Zody LX At-A-Glance

## General Specifications

<b>Environmental Factors</b>	<ul style="list-style-type: none"> <li>• Zody LX has been evaluated for its human health, environmental health, lifecycle attributes, renewable energy, water stewardship and social responsibility characteristics against stringent certification criteria and is considered an ecologically intelligent product.</li> <li>• Refer to Product Environmental Data sheet (PED) for recycled content and certifications.</li> <li>• Zody LX is produced in an ISO 14001 certified manufacturing facility.</li> <li>• Components are identified with ISO recycling symbols and material information to assist in the recycling effort, where practical.</li> <li>• Haworth will take back Zody LX chairs after their useful life and recycle the components. Please contact Haworth's Material Recovery Center at (616)393-1215.</li> </ul>
<b>COM &amp; COL General Information</b>	<p>To order a COM fabric (Customer's Own Material), contact the Haworth Inquiry Center (1.800.426.8562), your local Haworth dealer, or go to <a href="https://surfaces.haworth.com">surfaces.haworth.com</a> to find out if the COM you have selected has already been tested and approved. The surface collection site also has information on the Haworth alliance program with Carnegie, Luna Textiles, and Maharam as well as our industry-leading Pre-Approved COM program.</p> <p>COM fabrics are placed into Grades based on the cost per linear yard. If a fabric's cost exceeds the range of our highest Grade it will be noted as Non-Graded. The product will be priced at Grade A; the COM fabric costs will appear as a separate line item. The fabric charge will be Haworth's purchase cost plus a 4% administrative fee (based on the cost of the fabric). Yardage calculations will include any applicable fabric repeat.</p> <p>COM Leather products will be priced at a leather Grade A; COL costs will appear as a separate line item. The leather costs will be Haworth's purchase cost plus a 4% administrative fee (based on the cost of the leather).</p>
<b>Finishes and Fabrics</b>	For available finishes and fabrics please visit <a href="https://surfaces.haworth.com">surfaces.haworth.com</a>
<b>Stain Repellent</b>	<p>Stain Repellent or Stain Repellent with Moisture Barrier available on fabric surfaces only.</p> <p>Stain Repellent only: To specify add "P" to the end of the product number. Example: SZUC-22-731A5AP</p> <p>Stain Repellent with Moisture Barrier: To specify add "D" to the end of the product number. Example: SZUC-22-731A5AD</p>
<b>Shipping Weights (Including packaging)</b>	<ul style="list-style-type: none"> <li>• Chairs with arms: 58 pounds/1 chair per carton/19.4 cubic feet</li> <li>• Chairs without arms: 52.6 pounds/1 chair per carton/19.4 cubic feet</li> <li>• Dual Posture with arms: 60.6 pounds/1 chair per carton/22.1 cubic feet</li> <li>• Dual Posture without arms: 55.2 pounds/1 chair per carton/22.1 cubic feet</li> <li>• Stool with arms: 61 pounds/1 stool per carton/22.1 cubic feet</li> <li>• Stool without arms: 55.6 pounds/1 stool per carton/22.1 cubic feet</li> </ul>

# Zody LX

## General Specifications

### STANDARD MOBILITY AND ADJUSTABILITY

#### Balanced 3-point tilt



#### Features:

- Balanced 3-point tilt mechanism.
- Back reclines 24° from the upright position.
- Seat pan moves downward 3° from the initial position.

#### Benefits:

- Comfortable relaxed posture.
- Recline allows for the opening of the users' chest cavity providing good airflow to promote alertness.
- Users' feet remain flat.

#### Tilt Tension Control

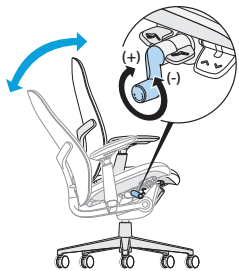

#### Feature:

- Easy-to-reach and easy-to-activate side-mounted tilt tension control regulates the amount of resistance felt when leaning back in the chair and the effort required to recline the chair backwards.

#### Benefit:

- Personalized support to accommodate users of different body types and different work styles.

#### Seat Height Adjustment

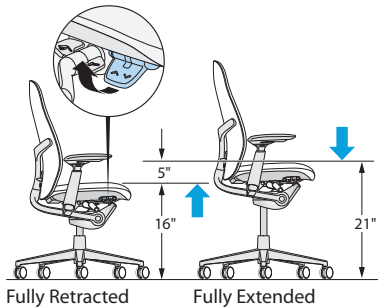

#### Features:

- Pneumatic seat height adjustment.
- Task chair seat height adjusts 5" (127mm) from 16" to 21" (406mm to 533mm) in standard models. Low-position adjusts 14.7" to 18" (373 to 457mm).
- Task stool seat height adjusts 7.3" (185mm) from 21" to 28.3" (533mm to 719mm).
- Dual Posture adjusts 17.5" to 24.2" (445mm to 615mm).

#### Benefits:

- Ensures the comfort of the lower limbs by avoiding pressure on the underside of the thigh caused by a seat pan that is too high, or decreased thigh-to-torso angle if the seat pan is too low.
- Accommodates for users between approximately 4'11" (1499mm) and 6'3" (1905mm) tall to provide good leg circulation.
- Seat height adjustment also is important in setting the proper hand position and allowing for a proper sitting eye height.

#### Seat Depth Adjustment

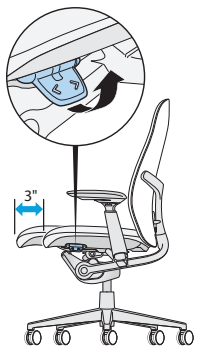

#### Features:

- 3" (76mm) of seat depth range.
- Waterfall edge.

#### Benefit:

- Supports the thighs, allows users to rest against the seat back for back support, and avoids pressure on the back of the knees of small to tall users.



**Zody LX**

## General Specifications

## OPTIONAL MOBILITY AND ADJUSTABILITY

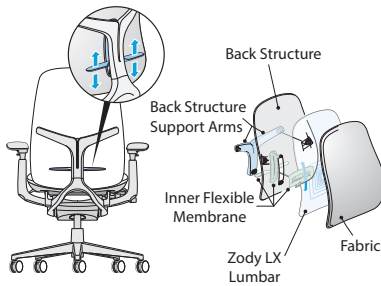
**Lumbar****Features:**

- Optional height adjustable lumbar.
- Range of 4"(102mm) of height adjustment.

**Benefits:**

- Lumbar adjustment maintains the natural curvature of the spine at the lower back and allows users to choose the support that feels right for them.

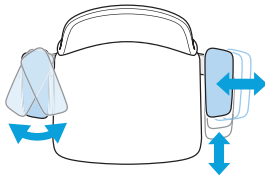
**4D Arm****Features:**

- Optional 4D arm.
- Arm adjusts in 4 ways:
  - Height adjustment: 4"(102mm)
  - Side-to-side arm cap adjustment range: 4"(102mm) [2"(51mm) each arm cap]
  - Front-to-back adjustment range: 2"(51mm)
  - Pivoting: In 20°; out 20°

**Benefits:**

- Arms support the muscular system of users' neck and shoulders and proper arm support provides back relief. Arms can be an aid in standing or sitting down.
- Height adjustment accommodates for users with varying elbow rest heights so that users avoid lifting their shoulders or leaning sideways to get arm support.
- Front-to-back adjustment adjusts the armrest length, which is important because it allows users to get close to the worksurface while maintaining the effective use of the backrest.
- Side-to-side adjustment ensures a comfortable resting position for the arms with proper support of the forearm while allowing for easy entry/exit of the chair.
- Pivoting provides proper support of the forearm when performing tasks involving keying and mousing.

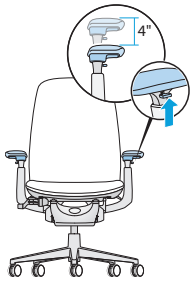
**Adjustable Height Arm****Feature:**

- Optional height adjustable arms adjust 4"(102mm) vertically.

**Benefit:**

- Height adjustment accommodates users with varying elbow rest heights so that users avoid lifting their shoulders or leaning sideways to get arm support.

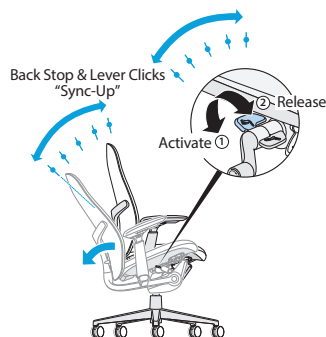
**Back Stop****Features:**

- Optional back stop;
- Back stops in 6 positions - upright and every 4° backward.

**Benefit:**

- Allows users the choice of selecting an upright position or limiting the amount of recline while performing different tasks.

# Zody LX

## General Specifications

### OPTIONAL MOBILITY AND ADJUSTABILITY (continued)

#### Back Stop/Forward Tilt

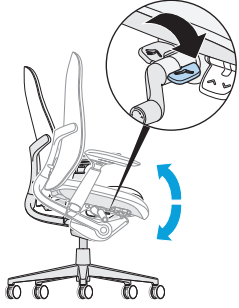

**Feature:**

- Optional back-stop and forward tilt.
- Back stops in 6 positions, upright and every 4° backward.
- Seat pan moves downward 5° from the initial position.

**Benefits:**

- Allows users to sit forward in the chair for task intensive work.
- Allows users to vary their posture for maximum comfort and for changes in task requirements.

**Note:** Not available on task stool.

#### Dual Posture

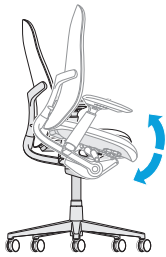

**Features:**

- Increased seat height range of 17.5”(445mm)-24.2”(615mm).
- Seat pan moves downward 5° from initial position with an increased degree of forward tilt.

**Benefit:**

- Promotes the in-between “perch” posture of sit-to-stand. Ideal for use with a height adjustable table.

#### Base

##### Standard Plastic Base

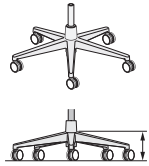

- TR-F Black
- TR-7 Fog

**Note:** When plastic base is specified all metal trim defaults to base color.

Hard casters in Black or Two-Tone Grey.  
Soft casters in Black.

##### Optional Aluminum Base

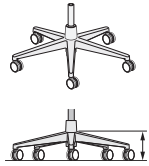

- TR-TF Pitch
- TR-LE Metallic Silver
- TR-MC Metallic Champagne
- TR-UFS Snowfall
- PM-P Polished Aluminum

Hard casters in Black, Two-Tone White or Two-Tone Grey.  
Soft casters in Black.

##### Low Position Base (Aluminum only)

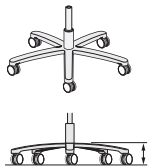

- TR-TF Pitch
- TR-LE Metallic Silver
- TR-MC Metallic Champagne
- TR-UFS Snowfall

Soft casters in Black.

#### Ergonomic Standards Guidelines

- All Zody LX models meet or exceed all ANSI/BIFMA durability standards for office seating.
- Zody LX meets the following ergonomic standards/guidelines:
  - BSR/HFES 100-2002
  - BIFMA G1-2002
  - CSA-Z412-2000
  - CAN/CGSB 44.232-2002
  - HFES 2007

# Zody LX

## Task Chair



S2UC-22-0



S2UC-22-1



S2UC-22-4



S2UC-22-7

### Dimensions\*

- \*SH: 16"-21"(406mm-533mm)  
(Std. base)  
14.7"-18"(373mm-457mm)  
(Low base)
- H: 38.8"-43.8"(986mm-1113mm)  
(Std. base)  
37.5"-40.8"(953mm-1036mm)  
(Low base)
- D: 29"(737mm)
- W: 29"(737mm)
- \*SW: 19.5"(495mm)
- \*SD: 16.4"-19.4"(417mm-493mm)
- \*AH: 7.6"-11.6"(193mm-295mm)  
(Height Adjustable and 4D)  
8.5"(216mm) (Fixed)

\* Measurements taken with ISO chair measuring device.

### Features

- Back: Fully upholstered.
- Seat: Upholstered with 3"(76mm) adjustable seat depth range.
- Base options:
  - Plastic standard five-star base.  
Casters: Hard casters in black or two-tone grey; Soft casters black only.
  - Aluminum standard five-star base.  
Casters: Hard casters in black, two-tone white or two-tone grey; Soft casters black only.
  - Aluminum low-position five-star base.  
Not available in PM-P Polished Aluminum.  
Casters: Hard or soft casters in black only.
  - Aluminum base available on chairs with arms only.  
Not available on armless chairs.
- Arm options:
  - No arms
  - Fixed arms; Optional leather arm caps available when leather seat is specified. Leather arm caps will match seat.
  - Height Adjustable; 4"(102mm) height adjustment range.
  - 4D; 4"(102mm) height adjustment, 4"(102mm) side-to-side range, 2"(51mm) front-to-back range and pivots 20° in and 20° out.
- Arm Cap will match plastic trim color (Black or Fog). When Snow is specified, arm cap will default to Fog.
- Height adjustment: Pneumatic or low-position pneumatic.
- Back Stop: Tilt stop in 6 positions.
- Back Stop/Forward Tilt; Tilt stop in 6 positions plus forward tilt 5° downward from initial position.
- Lumbar adjustment options:
  - No Lumbar
  - Height Adjustable Lumbar: 4"(102mm) height adjustment.
- COM yardage / COL square footage:  
Back: 0.80/12  
Seat: 0.75/10

Upcharge for mixed grade surfaces, refer to the electronic design and specification tools.

### To Order, Specify:

- 1) Product number, including:

#### 1 Seat Material

- 1 Leather
- 2 Fabric
- 3 Faux Leather

#### 2 Back Material

- 1 Leather
- 2 Fabric
- 3 Faux Leather

#### 3 Base/Caster Option:

##### Plastic Base

- 5 Plastic Base, Hard Caster
- 6 Plastic Base, Soft Caster, add **\$60.74** list
- 7 Plastic Base, Two-Tone Grey Caster, add **\$23.33** list

##### Aluminum Base

- 1 Aluminum Base, Hard Caster, add **\$104.97** list
- 2 Aluminum Base, Soft Caster, add **\$165.71** list
- T Aluminum Base, Two-Tone Grey Caster, add **\$128.30** list
- W Aluminum Base, White Caster, add **\$128.30** list

##### Low Base - Aluminum

- 3 Aluminum Low Base, Hard Caster, add **\$104.97** list
- 4 Aluminum Low Base, Soft Caster, add **\$165.71** list

- 2) Seat upholstery.
- 3) Back upholstery.
- 4) Plastic trim color.<sup>1</sup>
  - TR-F Black
  - TR-7 Fog, add **\$104.97** list
  - TR-UFM Snow,<sup>2</sup> add **\$174.95** list
- 5) Aluminum trim color.<sup>3</sup>
  - TR-TF Pitch
  - TR-LE Metallic Silver
  - TR-MC Metallic Champagne
  - TR-UFS Snowfall
  - PM-P Polished Aluminum
- 6) Base trim color.
  - Plastic
  - TR-F Black
  - TR-7 Fog, add **\$23.33** list
  - Aluminum
  - TR-TF Pitch
  - TR-LE Metallic Silver
  - TR-MC Metallic Champagne
  - TR-UFS Snowfall, add **\$23.33** list
  - PM-P Polished Aluminum, add **\$338.23** list

<sup>1</sup> Plastic trim color for Y-brace, arm caps, seat pan cover.

<sup>2</sup> When TR-UFM Snow trim is specified, arm cap and head rest will default to TR-7 Fog.

<sup>3</sup> Aluminum trim color for back support, arm supports/uprights.

# Zody LX

## Task Chair

Plastic Base* Adjustments	Arm	Number ① ②	③	Fabric Grade								Leather Grade A	Leather Grade B
				A	B	C	D	E	F	G	H		
<b>No Lumbar Adjustment</b>													
Back Stop	No arm	S2UC-■ ■ -001A	A	\$1352.90	\$1439.37	\$1531.53	\$1577.69	\$1612.25	\$1695.85	\$1770.72	\$1975.34	\$2750.24	\$3217.91
	Fixed	S2UC-■ ■ -101A	A	1539.51	1625.98	1718.14	1764.30	1798.86	1882.46	1957.33	2161.95	2936.85	3404.52
	Height Adjustable	S2UC-■ ■ -401A	A	1586.16	1672.63	1764.79	1810.95	1845.51	1929.11	2003.98	2208.60	2983.50	3451.17
	4D	S2UC-■ ■ -701A	A	1625.81	1712.28	1804.44	1850.60	1885.16	1968.76	2043.63	2248.25	3023.15	3490.82
Back Stop/ Forward Tilt	No arm	S2UC-■ ■ -004A	A	1476.53	1563.00	1655.16	1701.32	1735.88	1819.48	1894.35	2098.97	2873.87	3341.54
	Fixed	S2UC-■ ■ -104A	A	1663.14	1749.61	1841.77	1887.93	1922.49	2006.09	2080.96	2285.58	3060.48	3528.15
	Height Adjustable	S2UC-■ ■ -404A	A	1709.79	1796.26	1888.42	1934.58	1969.14	2052.74	2127.61	2332.23	3107.13	3574.80
	4D	S2UC-■ ■ -704A	A	1749.44	1835.91	1928.07	1974.23	2008.79	2092.39	2167.26	2371.88	3146.78	3614.45
<b>Height Adjustable Lumbar</b>													
Back Stop	No arm	S2UC-■ ■ -031A	A	\$1466.03	\$1552.50	\$1644.66	\$1690.82	\$1725.38	\$1808.98	\$1883.85	\$2088.47	\$2863.37	\$3331.04
	Fixed	S2UC-■ ■ -131A	A	1652.64	1739.11	1831.27	1877.43	1911.99	1995.59	2070.46	2275.08	3049.98	3517.65
	Height Adjustable	S2UC-■ ■ -431A	A	1699.29	1785.76	1877.92	1924.08	1958.64	2042.24	2117.11	2321.73	3096.63	3564.30
	4D	S2UC-■ ■ -731A	A	1738.94	1825.41	1917.57	1963.73	1998.29	2081.89	2156.76	2361.38	3136.28	3603.95
Back Stop/ Forward Tilt	No arm	S2UC-■ ■ -034A	A	1589.66	1676.13	1768.29	1814.45	1849.01	1932.61	2007.48	2212.10	2987.00	3454.67
	Fixed	S2UC-■ ■ -134A	A	1776.27	1862.74	1954.90	2001.06	2035.62	2119.22	2194.09	2398.71	3173.61	3641.28
	Height Adjustable	S2UC-■ ■ -434A	A	1822.92	1909.39	2001.55	2047.71	2082.27	2165.87	2240.74	2445.36	3220.26	3687.93
	4D	S2UC-■ ■ -734A	A	1862.57	1949.04	2041.20	2087.36	2121.92	2205.52	2280.39	2485.01	3259.91	3727.58

\* Pricing based on Plastic base with hard casters.

The following options require modification of the product number.

Leather Arm Caps (Fixed arm only)

To specify, change the 7th digit to an L; **Example:** S2UC-11-L04A5A (add \$303.24 list)

**Note:** Leather arm caps available only when leather seat is specified. Arm cap will match seat.

Stain Repellent

To specify, add P to end of the product number; **Example:** S2UC-22-731A5AP (add \$40.82 list)

# Zody LX

## Stool



S2US-22-0



S2US-22-1



S2US-22-4



S2US-22-7

### Dimensions\*

- \*SH: 21"-28.3"(533mm-719mm)
- H: 43.8"-51.1"(1113mm-1298mm)
- D: 29"(737mm)
- W: 29"(737mm)
- \*SW: 19.5"(495mm)
- \*SD: 16.4"-19.4"(417mm-493mm)
- \*AH: 7.6"-11.6"(193mm-295mm)  
(Height Adjustable and 4D)  
8.5"(216mm) (Fixed)

\* Measurements taken with ISO chair measuring device.

### Features

- Back: Fully upholstered.
- Seat: Upholstered with 3"(76mm) adjustable seat depth range.
- Base options:
  - Plastic standard five-star base.  
Casters: Hard casters in black or two-tone grey; Soft casters black only.
  - Aluminum standard five-star base.  
Casters: Hard casters in black, two-tone white or two-tone grey; Soft casters black only.
  - Aluminum base available on chairs with arms only. Not available on armless chairs.
- Arm options:
  - No arms
  - Fixed arms; Optional leather arm caps available when leather seat is specified. Leather arm caps will match seat.
  - Height Adjustable; 4"(102mm) height adjustment range.
  - 4D; 4"(102mm) height adjustment, 4"(102mm) side-to-side range, 2"(51mm) front-to-back range and pivots 20° in and 20° out.
- Arm Cap will match plastic trim color (Black or Fog). When Snow is specified, arm cap will default to Fog.
- Height adjustment: Pneumatic.
- Back Stop: Tilt stop in 6 positions.
- Lumbar adjustment options:
  - No Lumbar
  - Height Adjustable Lumbar: 4"(102mm) height adjustment.
- COM yardage / COL square footage:  
Back: 0.80/12  
Seat: 0.75/10

Upcharge for mixed grade surfaces, refer to the electronic design and specification tools.

### To Order, Specify:

- 1) Product number, including:

#### 1 Seat Material

- 1 Leather
- 2 Fabric
- 3 Faux Leather

#### 2 Back Material

- 1 Leather
- 2 Fabric
- 3 Faux Leather

#### 3 Base/Caster Option:

##### Plastic Base

- 5 Plastic Base, Hard Caster
- 6 Plastic Base, Soft Caster, add **\$60.74** list
- 7 Plastic Base, Two-Tone Grey Caster, add **\$23.33** list

##### Aluminum Base

- 1 Aluminum Base, Hard Caster, add **\$104.97** list
- 2 Aluminum Base, Soft Caster, add **\$165.71** list
- T Aluminum Base, Two-Tone Grey Caster, add **\$128.30** list
- W Aluminum Base, White Caster, add **\$128.30** list

- 2) Seat upholstery.
- 3) Back upholstery.
- 4) Plastic trim color.<sup>1</sup>
  - TR-F Black
  - TR-7 Fog, add **\$104.97** list
  - TR-UFM Snow,<sup>2</sup> add **\$174.95** list
- 5) Aluminum trim color.<sup>3</sup>
  - TR-TF Pitch
  - TR-LE Metallic Silver
  - TR-MC Metallic Champagne
  - TR-UFS Snowfall
  - PM-P Polished Aluminum
- 6) Base trim color.
  - Plastic
    - TR-F Black
    - TR-7 Fog, add **\$23.33** list
  - Aluminum
    - TR-TF Pitch
    - TR-LE Metallic Silver
    - TR-MC Metallic Champagne
    - TR-UFS Snowfall, add **\$23.33** list
    - PM-P Polished Aluminum, add **\$338.23** list

<sup>1</sup> Plastic trim color for Y-brace, arm caps, seat pan cover.

<sup>2</sup> When TR-UFM Snow trim is specified, arm cap will default to TR-7 Fog.

<sup>3</sup> Aluminum trim color for back support, arm supports/uprights.

# Zody LX

## Stool

Plastic Base* Adjustments	Arm	Number			Fabric Grade								Leather Grade A	Leather Grade B	
		①	②	③	A	B	C	D	E	F	G	H			
<b>No Lumbar Adjustment</b>															
Back Stop	No arm	S2US-		-001A	A	\$1652.64	\$1739.11	\$1831.27	\$1877.43	\$1911.99	\$1995.59	\$2070.46	\$2275.08	\$3049.98	\$3517.65
	Fixed	S2US-		-101A	A	1839.25	1925.72	2017.88	2064.04	2098.60	2182.20	2257.07	2461.69	3236.59	3704.26
	Height Adjustable	S2US-		-401A	A	1885.90	1972.37	2064.53	2110.69	2145.25	2228.85	2303.72	2508.34	3283.24	3750.91
	4D	S2US-		-701A	A	1925.55	2012.02	2104.18	2150.34	2184.90	2268.50	2343.37	2547.99	3322.89	3790.56
<b>Height Adjustable Lumbar</b>															
Back Stop	No arm	S2US-		-031A	A	\$1765.77	\$1852.24	\$1944.40	\$1990.56	\$2025.12	\$2108.72	\$2183.59	\$2388.21	\$3163.11	\$3630.78
	Fixed	S2US-		-131A	A	1952.38	2038.85	2131.01	2177.17	2211.73	2295.33	2370.20	2574.82	3349.72	3817.39
	Height Adjustable	S2US-		-431A	A	1999.03	2085.50	2177.66	2223.82	2258.38	2341.98	2416.85	2621.47	3396.37	3864.04
	4D	S2US-		-731A	A	2038.68	2125.15	2217.31	2263.47	2298.03	2381.63	2456.50	2661.12	3436.02	3903.69

\* Pricing based on Plastic base with hard casters.

The following options require modification of the product number.

Leather Arm Caps (Fixed arm only)

To specify, change the 7th digit to an **L**; **Example:** S2US-11-L31A5A (add **\$303.24** list)

**Note:** Leather arm caps available only when leather seat is specified. Arm cap will match seat.

Stain Repellent

To specify, add **P** to end of the product number; **Example:** S2US-22-701A5AP (add **\$40.82** list)

**Zody LX**

Dual Posture



S2UD-22-1



S2UD-22-4



S2UD-22-7

**Dimensions\***

- \*SH: 17.5"-24.2"(445mm-615mm)
- H: 40.3"-47"(1024mm-1194mm)
- D: 29"(737mm)
- W: 29"(737mm)
- \*SW: 19.5"(495mm)
- \*SD: 16.4"-19.4"(417mm-493mm)
- \*AH: 7.6"-11.6"(193mm-295mm)
- (Height Adjustable and 4D)
- 8.5"(216mm) (Fixed)

\* Measurements taken with ISO chair measuring device.

**Features**

- Back: Fully upholstered.
- Seat: Upholstered with 3"(76mm) adjustable seat depth range.
- Base options:
  - Aluminum standard five-star base.
  - Casters: Hard casters in black, two-tone white or two-tone grey; Soft casters black only.
- Arm options:
  - Fixed arms; Optional leather arm caps available when leather seat is specified. Leather arm caps will match seat.
  - Height Adjustable; 4"(102mm) height adjustment range.
  - 4D; 4"(102mm) height adjustment, 4"(102mm) side-to-side range, 2"(51mm) front-to-back range and pivots 20° in and 20° out.
- Arm Cap will match plastic trim color (Black or Fog). When Snow is specified, arm cap will default to Fog.
- Height adjustment: Pneumatic.
- Back Stop/Forward Tilt; Tilt stop in 6 positions plus forward tilt 5° downward from initial position.
- Lumbar adjustment options:
  - No Lumbar
  - Height Adjustable Lumbar: 4"(102mm) height adjustment.
- COM yardage / COL square footage:
  - Back: 0.80/12
  - Seat: 0.75/10

Upcharge for mixed grade surfaces, refer to the electronic design and specification tools.

**To Order, Specify:**

1) Product number, including:

**1 Seat Material**

- 1** Leather
- 2** Fabric
- 3** Faux Leather

**2 Back Material**

- 1** Leather
- 2** Fabric
- 3** Faux Leather

**3 Base/Caster Option:****Aluminum Base**

- 1** Aluminum Base, Hard Caster
- 2** Aluminum Base, Soft Caster, add **\$60.74** list
- T** Aluminum Base, Two-Tone Grey Caster, add **\$23.33** list
- W** Aluminum Base, White Caster, add **\$23.33** list

- 2) Seat upholstery.
- 3) Back upholstery.
- 4) Plastic trim color.<sup>1</sup>
  - TR-F Black
  - TR-7 Fog, add **\$104.97** list
  - TR-UFM Snow,<sup>2</sup> add **\$174.95** list
- 5) Aluminum trim color.<sup>3</sup>
  - TR-TF Pitch
  - TR-LE Metallic Silver
  - TR-MC Metallic Champagne
  - TR-UFS Snowfall
  - PM-P Polished Aluminum
- 6) Base trim color.
  - TR-TF Pitch
  - TR-LE Metallic Silver
  - TR-MC Metallic Champagne
  - TR-UFS Snowfall, add **\$23.33** list
  - PM-P Polished Aluminum, add **\$338.23** list

<sup>1</sup> Plastic trim color for Y-brace, arm caps, seat pan cover.

<sup>2</sup> When TR-UFM Snow trim is specified, arm cap will default to TR-7 Fog.

<sup>3</sup> Aluminum trim color for back support, arm supports/uprights.

# Zody LX

Dual Posture

Adjustments	Arm	Number			Fabric Grade								Leather Grade A	Leather Grade B			
		①	②	③	A	B	C	D	E	F	G	H					
<b>No Lumbar Adjustment</b>																	
Back Stop/ Forward Tilt	Fixed	S2UD-	■	■	-104A	■	A	\$2001.37	\$2087.84	\$2180.00	\$2226.16	\$2260.72	\$2344.32	\$2419.19	\$2623.81	\$3398.71	\$3866.38
	Height Adjustable	S2UD-	■	■	-404A	■	A	2048.02	2134.49	2226.65	2272.81	2307.37	2390.97	2465.84	2670.46	3445.36	3913.03
	4D	S2UD-	■	■	-704A	■	A	2087.67	2174.14	2266.30	2312.46	2347.02	2430.62	2505.49	2710.11	3485.01	3952.68
<b>Height Adjustable Lumbar Adjustment</b>																	
Back Stop/ Forward Tilt	Fixed	S2UD-	■	■	-134A	■	A	\$2114.50	\$2200.97	\$2293.13	\$2339.29	\$2373.85	\$2457.45	\$2532.32	\$2736.94	\$3511.84	\$3979.51
	Height Adjustable	S2UD-	■	■	-434A	■	A	2161.15	2247.62	2339.78	2385.94	2420.50	2504.10	2578.97	2783.59	3558.49	4026.16
	4D	S2UD-	■	■	-734A	■	A	2200.80	2287.27	2379.43	2425.59	2460.15	2543.75	2618.62	2823.24	3598.14	4065.81

The following options require modification of the product number.

Leather Arm Caps (Fixed arm only)

To specify, change the 7th digit to an L; **Example:** S2UD-11-L04A1A (add \$303.24 list)

**Note:** Leather arm caps available only when leather seat is specified. Arm cap will match seat.

Stain Repellent

To specify, add P to end of the product number; **Example:** S2UD-22-704A1AP (add \$40.82 list)



# Zody-At-A-Glance

<b>Designer</b>	ITO Design and Haworth Design Studio
<b>Awards/Achievements</b>	NeoCon Silver, Best of NeoCon, Seating: Ergonomic Desk/Task, June 2005, USA IIDEX/NeoCon Gold, Seating: Desk/Workstation Chairs, September 2005, Canada BIFMA level 3 certified.
<b>Zody</b>	A high-performing chair that blends science-based wellness and comfort with sustainability and international design.

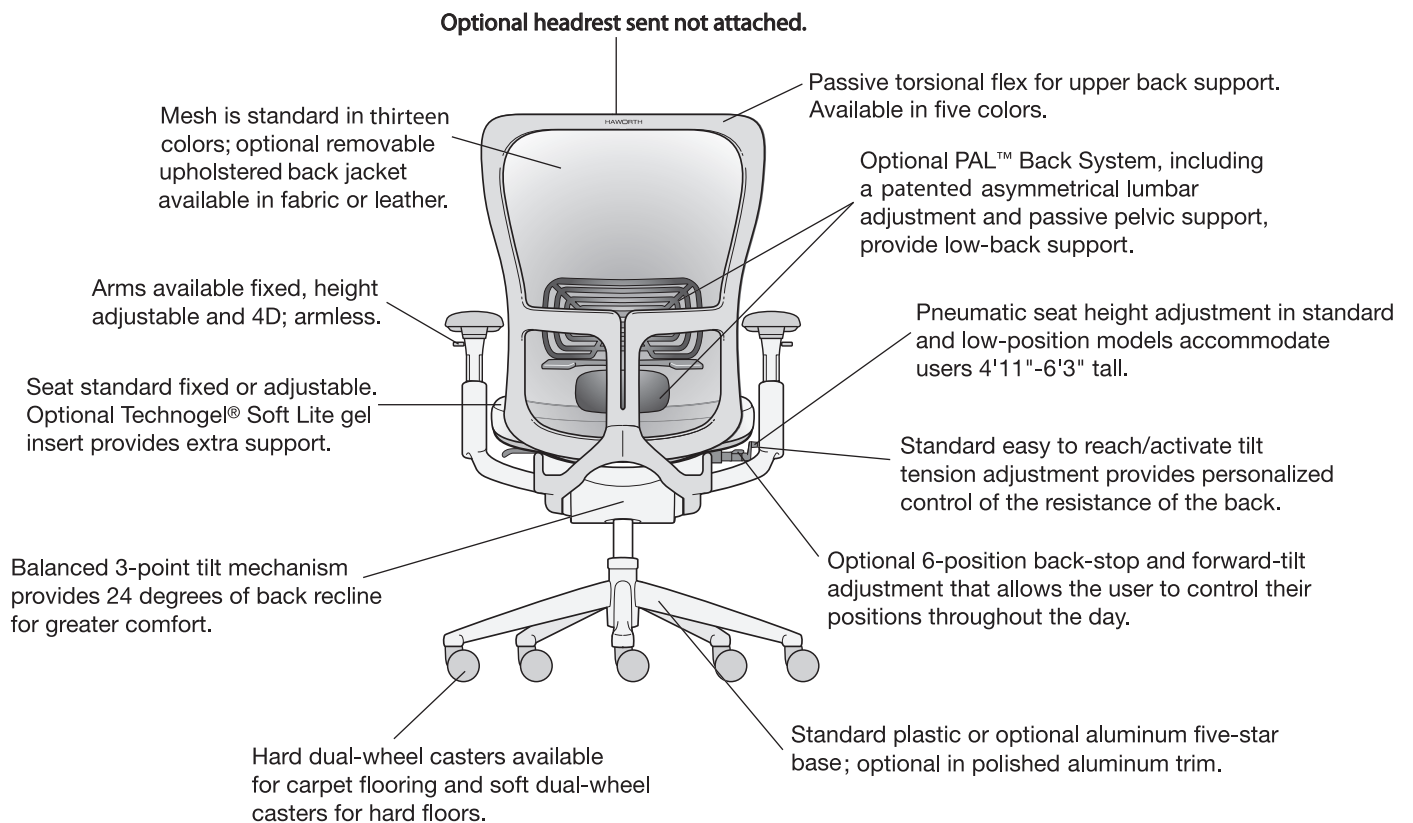

**Note:** Headrest and forward-tilt options not available on Stool.

# Zody-At-A-Glance

## General Specifications

### General Guidelines for Product Specification

Zody seating specification numbers are based on an alpha-numeric logic that identifies a product by model and certain characteristics.

For example, a product number that reads **SZT-20-702MA5 3A-18 MA-001 TR-F TR-F** identifies the product as a Zody mesh back chair with 4D arms, no lumbar, pneumatic seat height adjustment, foam adjustable seat and standard plastic base TR-F black only with hard casters. The numeric logic for this model with fabric and finish codes is shown below:

#### Mesh Back

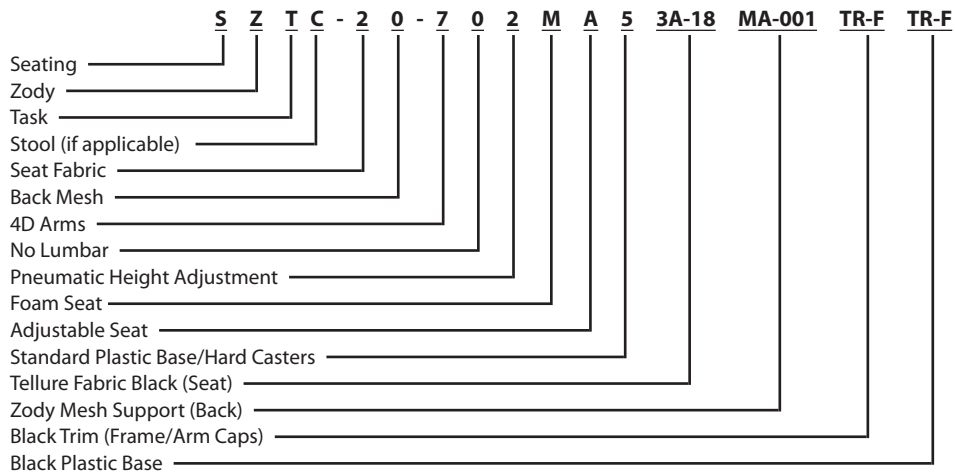

#### Mesh Back with Upholstered Back Jacket

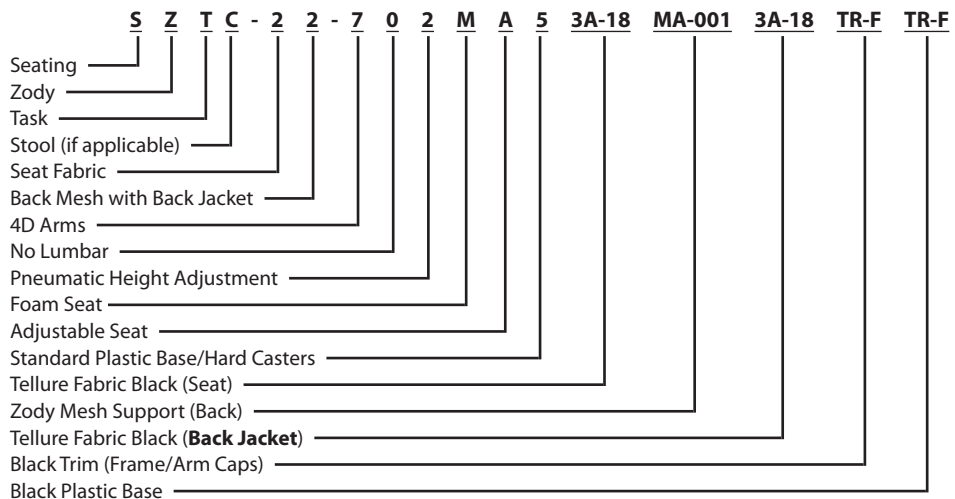

There are exceptions to this logic; therefore, always refer to the price charts for product numbers rather than attempting to construct them. Product number modification instructions for additional options appear in footnoted copy for each applicable model.

Beyond the printed product number, fabric and finish codes are required to complete an order specification. To communicate your order clearly, list the product number and fabric/finish codes in the sequence outlined on each price page.

**Zody-At-A-Glance**

## General Specifications

<b>Environmental Factors</b>	<ul style="list-style-type: none"> <li>• Zody has been evaluated for its human health, environmental health, lifecycle attributes, renewable energy, water stewardship and social responsibility characteristics against stringent certification criteria and is considered an ecologically intelligent product.</li> <li>• Refer to Product Environmental Data sheet (PED) for recycled content and certifications.</li> <li>• Zody is produced in an ISO 14001 certified manufacturing facility.</li> <li>• Components are identified with ISO recycling symbols and material information to assist in the recycling effort, where practical.</li> <li>• Haworth will take back Zody chairs after their useful life and recycle the components. Please contact Haworth's Material Recovery Center at (616)393-1215.</li> <li>• Optional Trivalent chrome finish provides safer and more environmentally friendly alternative for customers requiring the attributes of a chrome finish.</li> </ul>
<b>COM &amp; COL General Information</b>	<p>To order a COM fabric (Customer's Own Material), contact the Haworth Inquiry Center (1.800.426.8562), your local Haworth dealer, or go to <a href="http://surfaces.haworth.com">surfaces.haworth.com</a> to find out if the COM you have selected has already been tested and approved. The surface collection site also has information on the Haworth alliance program with Carnegie, Luna Textiles, and Maharam as well as our industry-leading Pre-Approved COM program.</p> <p>COM fabrics are placed into Grades based on the cost per linear yard. If a fabric's cost exceeds the range of our highest Grade it will be noted as Non-Graded. The product will be priced at Grade A; the COM fabric costs will appear as a separate line item. The fabric charge will be Haworth's purchase cost plus a 4% administrative fee (based on the cost of the fabric). Yardage calculations will include any applicable fabric repeat.</p> <p>COM Leather products will be priced at a leather Grade A; COL costs will appear as a separate line item. The leather costs will be Haworth's purchase cost plus a 4% administrative fee (based on the cost of the leather).</p>
<b>Finishes and Fabrics</b>	A complete listing of finishes and fabrics for Zody seating is available in the back of the price list.
<b>Shipping Weights (Including packaging)</b>	<ul style="list-style-type: none"> <li>• Chairs with arms: 55 pounds/1 chair per carton/17.3 cubic feet</li> <li>• Chairs without arms: 51 pounds/1 chair per carton/17.3 cubic feet</li> <li>• Chairs with sled base: 24 pounds/1 chair per carton/17.3 cubic feet</li> <li>• Chairs with leg base: 21 pounds/1 chair per carton/17.3 cubic feet</li> <li>• Stool with arms: 58 pounds/1 stool per carton/21.5 cubic feet</li> <li>• Stool without arms: 54 pounds/1 stool per carton/21.5 cubic feet</li> </ul>
<b>Stain Repellent</b>	<p>Stain Repellent or Stain Repellent with Moisture Barrier available on fabric surfaces only.</p> <p>Stain Repellent only: To specify add "<b>P</b>" to the end of the product number. Example: SZT-22-702MA1<b>P</b></p> <p>Stain Repellent with Moisture Barrier: To specify add "<b>D</b>" to the end of the product number. Example: SZT-22-702MA1<b>D</b></p>

# Zody

## General Specifications

### STANDARD MOBILITY AND ADJUSTABILITY

#### Balanced 3-point tilt

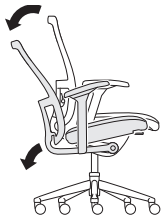

##### Features:

- Balanced 3-point tilt mechanism.
- Back reclines 24° from the upright position.
- Seat pan moves downward 3° from the initial position.

##### Benefits:

- Comfortable relaxed posture.
- Recline allows for the opening of the users' chest cavity providing good airflow to promote alertness.
- Users' feet remain flat.

#### Tilt Tension Control

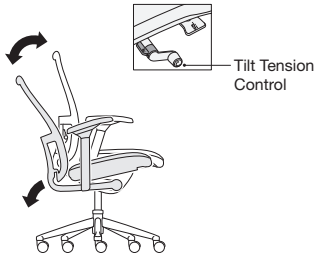

##### Feature:

- Easy-to-reach and easy-to-activate side-mounted tilt tension control regulates the amount of resistance felt when leaning back in the chair and the effort required to recline the chair backwards.

##### Benefit:

- Personalized support to accommodate users of different body types and different work styles.

#### Seat Height Adjustment

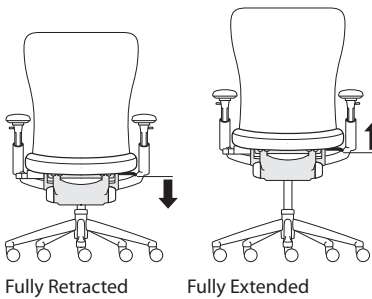

##### Features:

- Pneumatic seat height adjustment.
- Task chair seat height adjusts 5"(127mm) from 16" to 21"(406mm to 533mm) in standard models. Low-position adjusts 14" to 17"(356 to 432mm).
- Task stool seat height adjusts 7.5"(191mm) from 21.5" to 29"(546mm to 737mm).

##### Benefits:

- Ensures the comfort of the lower limbs by avoiding pressure on the underside of the thigh caused by a seat pan that is too high, or decreased thigh-to-torso angle if the seat pan is too low.
- Accommodates for users between approximately 4'11"(1499mm) and 6'3"(1905mm) tall to provide good leg circulation.
- Seat height adjustment also is important in setting the proper hand position and allowing for a proper sitting eye height.

#### Seat Depth Adjustment

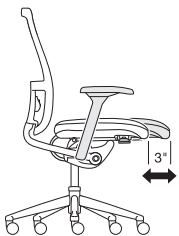

##### Features:

- 3"(76mm) of seat depth range. (Fixed seat also available.)
- Available with conventional foam material or optional Technogel® Soft Lite gel insert.
- Waterfall edge.

##### Benefit:

- Supports the thighs, allows users to rest against the seat back for back support, and avoids pressure on the back of the knees of small to tall users.

#### Upper Back Torsional Movement



##### Feature:

- Passive 2"(51mm) of torsional flex in the upper back.
- Patented mesh with built in tension zones for added comfort.

##### Benefit:

- Increases users' mobility and comfort when reaching sideways for objects.

# Zody

## General Specifications

### OPTIONAL MOBILITY AND ADJUSTABILITY

#### PAL Back System



#### Features:

- PAL Back System includes Asymmetrical Lumbar Adjustment and passive pelvic support.
- Asymmetrical Lumbar Adjustment adjusts 4"(102mm) in height; support level can be adjusted independently for right or left-hand side of users' body.
- Passive pelvic support.

#### Benefits:

- Lumbar adjustment maintains the natural curvature of the spine at the lower back and allows users to choose the support that feels right for them.
- Passive pelvic support rotates the pelvis forward to maintain the natural spine shape.

#### 4D Arm

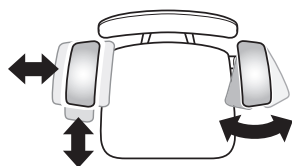

#### Features:

- Optional 4D arm.
- Arm adjusts in 4 ways:
  - Height adjustment: 4"(102mm)
  - Side-to-side arm cap adjustment range: 3"(76mm) [1.5"(38mm) each arm cap]
  - Front-to-back adjustment range: 3.5"(89mm)
  - Pivoting: In 20°; out 20°

#### Benefits:

- Arms support the muscular system of users' neck and shoulders and proper arm support provides back relief. Arms can be an aid in standing or sitting down.
- Height adjustment accommodates for users with varying elbow rest heights so that users avoid lifting their shoulders or leaning sideways to get arm support.
- Front-to-back adjustment adjusts the armrest length, which is important because it allows users to get close to the worksurface while maintaining the effective use of the backrest.
- Side-to-side adjustment ensures a comfortable resting position for the arms with proper support of the forearm while allowing for easy entry/exit of the chair.
- Pivoting provides proper support of the forearm when performing tasks involving keying and mousing.

#### Adjustable Height Arm

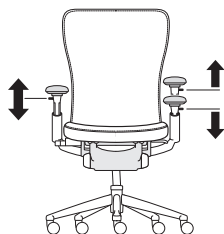

#### Feature:

- Optional height adjustable arms adjust 4"(102mm) vertically.

#### Benefit:

- Height adjustment accommodates users with varying elbow rest heights so that users avoid lifting their shoulders or leaning sideways to get arm support.

#### Tilt with Back Stop

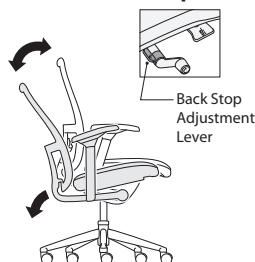

#### Features:

- Optional back stop;
- Back stops in 6 positions - upright and every 4° backward.
- Tilt limiter.

#### Benefit:

- Allows users the choice of selecting an upright position or limiting the amount of recline while performing different tasks.

# Zody

## General Specifications

### OPTIONAL MOBILITY AND ADJUSTABILITY (continued)

#### Back Stop/Forward Tilt

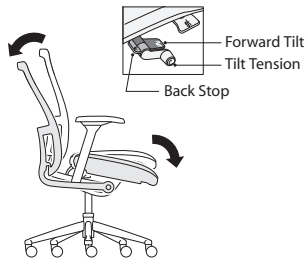

#### Feature:

- Optional back-stop and forward tilt.
- Back stops in 6 positions, upright and every 4° backward.
- Seat pan moves downward 5° from the initial position.

#### Benefit:

- Allows users to vary their posture for maximum comfort and for changes in task requirements.

**Note:** Not available on task stool.

#### Base

##### Standard Plastic Base

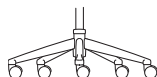

TR-F Black

**Note:** When plastic base is specified all metal trim defaults to Black (TF-F)

##### Optional Aluminum Base

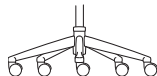

- TR-F Black
- TR-LE Metallic Silver
- TR-MC Metallic Champagne
- TR-MG Metallic Gunmetal\*
- PM-P Polished Aluminum

##### Low Position Base (Aluminum only)

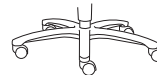

- TR-F Black
- TR-LE Metallic Silver
- TR-MC Metallic Champagne
- TR-MG Metallic Gunmetal\*

\*Color on Alert status and being considered for future obsolescence due to low volume.

**Note:** Low Position Base not available on stool.

#### Ergonomic Standards Guidelines

- All Zody models meet or exceed all ANSI/BIFMA durability standards for office seating.
- Zody meets the following ergonomic standards/guidelines:
  - BSR/HFES 100-2002
  - BIFMA G1-2002
  - CSA-Z412-2000
  - CAN/CGSB 44.232-2002
  - HFES 2007

# Zody

General Specifications  
UPHOLSTERY / AESTHETIC OPTIONS

### Leather Upholstery



**Seat:** Stitched double seams. Vertically in the center and on the edges of the seat cushion.

**Back:** Vertical stitched double seams on the upholstered back jacket with leather or Customers Own Leather (COL).

### Upholstered Back Jacket

#### Front View:

Leather Jacket



#### Back View:



#### Features

- Removable.
- Back jacket covers the inside back of the chairs allowing a back view of the mesh. Jacket consists of padding covered with fabric or leather upholstery.
- Available in fabric, faux leather, leather, COM and COL.

### Headrest



#### Features

- Height-adjustable 2.5" to fit a wide range of users, headrest is TPU material, like Zody arm.
  - Trim color of headrest front and back are in same color. Black or Smoke only. If a trim color other than Black or Smoke is specified, the headrest will default to Black or Smoke based on the matrix below.
  - Headrest sent not attached; 10.5"W x 7.5"H, 2.5" height adjustment.
  - See Zody price pages for specification (available on all task seating models). Not available on stools.  
Specification Example: SZE-22-722MA1 (Zody with headrest, 4D arm).
- To add a headrest to an existing model in the field order service part: Back and Headrest replacement, see e-Parts.

### Specification

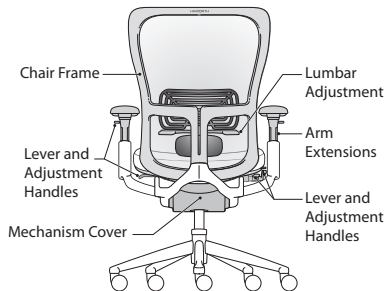

#### Features

- Trim color specification applies to the following components:
  - Chair frame
  - Levers
  - Adjustment handles
  - Lumbar adjustment (not lumbar pad)
  - Arm extensions
  - Mechanism covers
- Arm cap and Headrest color defaults based on the matrix below.

Trim Color	Arm Cap & Headrest Color*	
	Black	Smoke
Black (TR-F)	•	
Smoke (TR-E)		•
Snow (TR-UFM)		•

\*Not specifiable.

This page intentionally blank



# Zody

## Task Chair with 4D Arms



SZT-20-702MA1

### Dimensions\*

- \*SH: 16-21"  
(406mm-533mm)
- H: 38-43"(965mm-1092mm)
- D: 29"(737mm)
- W: 29"(737mm)
- \*SW: 19.25"(489mm)
- \*SD: 16-19"(406mm-483mm)
- \*AH: 6.8-10.8"  
(173mm-274mm)

Low position seat height:  
14-17"(356mm-432mm)

\* All measurements taken with the BIFMA chair measuring device.

Trim Color <sup>1</sup>	Arm Cap & Headrest Color*	
	Black	Smoke
Black (TR-F)	•	
Smoke (TR-E)		•
Snow (TR-UFM)		•

\*Not specifiable.

<sup>1</sup>Plastic base option will default all metal trim to Black (TR-F).

### Features

- Back: Knit, mesh, or mesh back with upholstered back jacket.
- Seat: Standard upholstered with foam or optional foam with Technogel® Soft Lite gel insert.
- Seat Type: Standard adjustable [3"(76mm) range] or optional fixed.
- Base: Standard Plastic painted five-star base or optional painted aluminum or polished aluminum.
  - Plastic base available in Black.
  - Aluminum base available with painted Black, Metallic Silver, Metallic Champagne, or optional Polished Aluminum.
- Arms: 4D with soft arm caps. See matrix for default colors.
- Mechanism: Balanced 3-point tilt; standard tilt tension.
- Height adjustment: Pneumatic or low-position pneumatic.
- Optional Back Stop: Tilt stop in 6 positions.
- Optional Back Stop with Forward Tilt; Seat tilts 5° downward from initial position.
- Optional Asymmetrical Lumbar Adjustment: 4"(102mm) height adjustment; support level can be adjusted independently for right or left hand side of users body. Optional PAL Back System: Passive pelvic support.
- Casters: Hard or soft casters in black only.
- COM yardage / COL square footage:
  - Mesh back model: .75/10
  - Mesh back/upholstered back jacket: 1.5/18

**NOTE:** When specifying fabric or leather back jacket; must also specify mesh surface color for outside back.

Upcharge for mixed grade surfaces, refer to the electronic design and specification tools.

### To Order with Fabric or Leather Upholstered Back Jacket Specify:

1) Product number, including:

#### 1 Base/Caster Option:

##### Aluminum Base

- 1 Aluminum Base, Hard Caster, add **\$128.29** to list
- 2 Aluminum Base, Soft Caster, add **\$191.31** to list
- 3 Aluminum Low Base, Hard Caster, add **\$128.29** to list
- 4 Aluminum Low Base, Soft Caster, add **\$191.31** to list

##### Plastic Base

- 5 Plastic Std. Base, Hard Caster
- 6 Plastic Std. Base, Soft Caster, add **\$63.02** to list

- 2) Fabric surface and color (seat).
- 3) Mesh surface color (back).
- 4) Fabric surface and color (back jacket).
- 5) Trim color for frame. (Add **\$85.44** list for Snow.)
- 6) Trim color for base/arms. (Add **\$291.78** list for polished aluminum.)

### To Order with Knit or Mesh Back Specify:

1) Product number, including:

#### 1 Base/Caster Option:

##### Aluminum Base

- 1 Aluminum Base, Hard Caster, add **\$128.92** to list
- 2 Aluminum Base, Soft Caster, add **\$191.31** to list
- 3 Aluminum Low Base, Hard Caster, add **\$128.29** to list
- 4 Aluminum Low Base, Soft Caster, add **\$191.31** to list

##### Plastic Base

- 5 Plastic Std. Base, Hard Caster
- 6 Plastic Std. Base, Soft Caster, add **\$63.02** to list

- 2) Fabric surface and color (seat).
- 3) Knit or Mesh surface and color (back).
- 4) Trim color for frame. (Add **\$85.44** list for Snow.)
- 5) Trim color for base/arms. (Add **\$291.78** list for polished aluminum.)

# Zody

## Task Chair with 4D Arms

Upholstered Foam Seat	Adjustments	Number	Fabric Grade								Leather Grade A	Leather Grade B
			A	B	C	D	E	F	G	H		
<b>No Lumbar Adjustment - Mesh Back w/Plastic Base</b>												
	Back Stop	SZT-20-701MA	\$1890.14	\$1942.56	\$1998.45	\$2026.42	\$2047.37	\$2098.07	\$2143.45	\$2267.52	\$2353.11	\$2580.68
	Back Stop/ Forward Tilt	SZT-20-704MA	1981.08	2033.50	2089.39	2117.36	2138.31	2189.01	2234.39	2358.46	2444.05	2671.62
<b>No Lumbar Adjustment - Knit Back w/Plastic Base</b>												
	Back Stop	SZT-20-701MA	\$2098.32	\$2150.74	\$2206.63	\$2234.60	\$2255.55	\$2306.25	\$2351.63	\$2475.70	\$2561.29	\$2788.86
	Back Stop/ Forward Tilt	SZT-20-704MA	2189.26	2241.68	2297.57	2325.54	2346.49	2397.19	2442.57	2566.64	2652.23	2879.80
<b>No Lumbar Adjustment - Upholstered Back Jacket w/Plastic Base</b>												
	Back Stop	SZT-22-701MA	\$2063.10	\$2167.94	\$2279.72	\$2335.66	\$2377.56	\$2478.96	\$2569.72	\$2817.86	\$2989.04	\$3444.18
	Back Stop/ Forward Tilt	SZT-22-704MA	2154.04	2258.88	2370.66	2426.60	2468.50	2569.90	2660.66	2908.80	3079.98	3535.12
<b>Lumbar Adjustment - Mesh Back w/Plastic Base</b>												
	Back Stop	SZT-20-711MA	\$2043.90	\$2096.32	\$2152.21	\$2180.18	\$2201.13	\$2251.83	\$2297.21	\$2421.28	\$2506.87	\$2734.44
	Back Stop/ Forward Tilt	SZT-20-714MA	2134.84	2187.26	2243.15	2271.12	2292.07	2342.77	2388.15	2512.22	2597.81	2825.38
<b>Lumbar Adjustment - Knit Back w/Plastic Base</b>												
	Back Stop	SZT-20-711MA	\$2252.08	\$2304.50	\$2360.39	\$2388.36	\$2409.31	\$2460.01	\$2505.39	\$2629.46	\$2715.05	\$2942.62
	Back Stop/ Forward Tilt	SZT-20-714MA	2343.02	2395.44	2451.33	2479.30	2500.25	2550.95	2596.33	2720.40	2805.99	3033.56
<b>Lumbar Adjustment - Upholstered Back Jacket w/Plastic Base</b>												
	Back Stop	SZT-22-711MA	\$2216.86	\$2321.70	\$2433.48	\$2489.42	\$2531.32	\$2632.72	\$2723.48	\$2971.62	\$3142.80	\$3597.94
	Back Stop/ Forward Tilt	SZT-22-714MA	2307.80	2412.64	2524.42	2580.36	2622.26	2723.66	2814.42	3062.56	3233.74	3688.88
<b>PAL Back System - Mesh Back w/Plastic Base</b>												
	Back Stop	SZT-20-721MA	\$2084.08	\$2136.50	\$2192.39	\$2220.36	\$2241.31	\$2292.01	\$2337.39	\$2461.46	\$2547.05	\$2774.62
	Back Stop/ Forward Tilt	SZT-20-724MA	2175.02	2227.44	2283.33	2311.30	2332.25	2382.95	2428.33	2552.40	2637.99	2865.56
<b>PAL Back System - Knit Back w/Plastic Base</b>												
	Back Stop	SZT-20-721MA	\$2292.26	\$2344.68	\$2400.57	\$2428.54	\$2449.49	\$2500.19	\$2545.57	\$2669.64	\$2755.23	\$2982.80
	Back Stop/ Forward Tilt	SZT-20-724MA	2383.20	2435.62	2491.51	2519.48	2540.43	2591.13	2636.51	2760.58	2846.17	3073.74
<b>PAL Back System - Upholstered Back Jacket w/Plastic Base</b>												
	Back Stop	SZT-22-721MA	\$2257.04	\$2361.88	\$2473.66	\$2529.60	\$2571.50	\$2672.90	\$2763.66	\$3011.80	\$3182.98	\$3638.12
	Back Stop/ Forward Tilt	SZT-22-724MA	2347.98	2452.82	2564.60	2620.54	2662.44	2763.84	2854.60	3102.74	3273.92	3729.06

The following options require modification of the product number.

- Fixed seat
- Headrest
- Stain repellent
- Leather Seat with Mesh Back
- Leather Seat with Leather Upholstered Back Jacket
- Faux Leather Seat with Mesh Back
- Faux Leather Seat with Faux Leather Upholstered Back Jacket

- To specify, change the 10th digit from A to X; **Example:** SZT-20-702MX1
- To specify, change the 3rd digit from a T to an E; **Example:** SZE-22-702MA1 with headrest (add \$90.84 list)
- To specify, add P to end of the product number (add \$54.18 list)
- To specify, change the 4th digit to 1 and 5th digit to 0; **Example:** SZT-10-702MA5
- To specify, change the 4th digit to 1 and 5th digit to 1; **Example:** SZT-11-702MA5
- To specify, change the 4th digit to 3; **Example:** SZT-30-702MA5
- To specify, change the 4th and 5th digits to 33; **Example:** SZT-33-702MA5

**NOTE:** For available fabrics, refer to [surfaces.haworth.com](https://surfaces.haworth.com).

# Zody

## Task Chair with 4D Arms

Upholstered		Fabric Grade										Leather	Leather
Gel Insert Seat	Adjustments	Number	A	B	C	D	E	F	G	H	Grade A	Grade B	
<b>No Lumbar Adjustment - Mesh Back w/Plastic Base</b>													
	Back Stop	SZT-20-701EA	\$2035.18	\$2087.60	\$2143.49	\$2171.46	\$2192.41	\$2243.11	\$2288.49	\$2412.56	\$2498.15	\$2725.72	
	Back Stop/ Forward Tilt	SZT-20-704EA	2126.12	2178.54	2234.43	2262.40	2283.35	2334.05	2379.43	2503.50	2589.09	2816.66	
<b>No Lumbar Adjustment - Knit Back w/Plastic Base</b>													
	Back Stop	SZT-20-701EA	\$2243.36	\$2295.78	\$2351.67	\$2379.64	\$2400.59	\$2451.29	\$2496.67	\$2620.74	\$2706.33	\$2933.90	
	Back Stop/ Forward Tilt	SZT-20-704EA	2334.30	2386.72	2442.61	2470.58	2491.53	2542.23	2587.61	2711.68	2797.27	3024.84	
<b>No Lumbar Adjustment - Upholstered Back Jacket w/Plastic Base</b>													
	Back Stop	SZT-22-701EA	\$2208.14	\$2312.98	\$2424.76	\$2480.70	\$2522.60	\$2624.00	\$2714.76	\$2962.90	\$3134.08	\$3589.22	
	Back Stop/ Forward Tilt	SZT-22-704EA	2299.08	2403.92	2515.70	2571.64	2613.54	2714.94	2805.70	3053.84	3225.02	3680.16	
<b>Lumbar Adjustment - Mesh Back w/Plastic Base</b>													
	Back Stop	SZT-20-711EA	\$2188.94	\$2241.36	\$2297.25	\$2325.22	\$2346.17	\$2396.87	\$2442.25	\$2566.32	\$2651.91	\$2879.48	
	Back Stop/ Forward Tilt	SZT-20-714EA	2279.88	2332.30	2388.19	2416.16	2437.11	2487.81	2533.19	2657.26	2742.85	2970.42	
<b>Lumbar Adjustment - Knit Back w/Plastic Base</b>													
	Back Stop	SZT-20-711EA	\$2397.12	\$2449.54	\$2505.43	\$2533.40	\$2554.35	\$2605.05	\$2650.43	\$2774.50	\$2860.09	\$3087.66	
	Back Stop/ Forward Tilt	SZT-20-714EA	2488.06	2540.48	2596.37	2624.34	2645.29	2695.99	2741.37	2865.44	2951.03	3178.60	
<b>Lumbar Adjustment - Upholstered Back Jacket w/Plastic Base</b>													
	Back Stop	SZT-22-711EA	\$2361.90	\$2466.74	\$2578.52	\$2634.46	\$2676.36	\$2777.76	\$2868.52	\$3116.66	\$3287.84	\$3742.98	
	Back Stop/ Forward Tilt	SZT-22-714EA	2452.84	2557.68	2669.46	2725.40	2767.30	2868.70	2959.46	3207.60	3378.78	3833.92	
<b>PAL Back System - Mesh Back w/Plastic Base</b>													
	Back Stop	SZT-20-721EA	\$2229.12	\$2281.54	\$2337.43	\$2365.40	\$2386.35	\$2437.05	\$2482.43	\$2606.50	\$2692.09	\$2919.66	
	Back Stop/ Forward Tilt	SZT-20-724EA	2320.06	2372.48	2428.37	2456.34	2477.29	2527.99	2573.37	2697.44	2783.03	3010.60	
<b>PAL Back System - Knit Back w/Plastic Base</b>													
	Back Stop	SZT-20-721EA	\$2437.30	\$2489.72	\$2545.61	\$2573.58	\$2594.53	\$2645.23	\$2690.61	\$2814.68	\$2900.27	\$3127.84	
	Back Stop/ Forward Tilt	SZT-20-724EA	2528.24	2580.66	2636.55	2664.52	2685.47	2736.17	2781.55	2905.62	2991.21	3218.78	
<b>PAL Back System - Upholstered Back Jacket w/Plastic Base</b>													
	Back Stop	SZT-22-721EA	\$2402.08	\$2506.92	\$2618.70	\$2674.64	\$2716.54	\$2817.94	\$2908.70	\$3156.84	\$3328.02	\$3783.16	
	Back Stop/ Forward Tilt	SZT-22-724EA	2493.02	2597.86	2709.64	2765.58	2807.48	2908.88	2999.64	3247.78	3418.96	3874.10	

The following options require modification of the product number.

- Fixed seat
- Headrest
- Stain repellent
- Leather Seat with Mesh Back
- Leather Seat with Leather Upholstered Back Jacket
- Faux Leather Seat with Mesh Back
- Faux Leather Seat with Faux Leather Upholstered Back Jacket

- To specify, change the 10th digit from A to X; **Example:** SZT-20-702EX1
  - To specify, change the 3rd digit from a T to an E; **Example:** SZE-22-702EA1 with headrest (add \$90.84 list)
  - To specify, add P to end of the product number (add \$54.18 list)
  - To specify, change the 4th digit to 1 and 5th digit to 0; **Example:** SZT-10-702EA5
  - To specify, change the 4th digit to 1 and 5th digit to 1; **Example:** SZT-11-702EA5
  - To specify, change the 4th digit to 3; **Example:** SZT-30-702EA5
  - To specify, change the 4th and 5th digits to 33; **Example:** SZT-33-702EA5
- NOTE:** For available fabrics, refer to [surfaces.haworth.com](https://surfaces.haworth.com).

This page intentionally blank

# Zody

## Task Chair with Height Adjustable Arms



SZT-20-402MA1

### Dimensions\*

- \*SH: 16-21"  
(406mm-533mm)
- H: 38-43"(965mm-1092mm)
- D: 29"(737mm)
- W: 29"(737mm)
- \*SW: 19.25"(489mm)
- \*SD: 16-19"(406mm-483mm)
- \*AH: 6.8-10.8"  
(173mm-274mm)

Low position seat height:  
14-17"(356mm-432mm)

\* All measurements taken with the BIFMA chair measuring device.

Trim Color <sup>1</sup>	Arm Cap & Headrest Color*	
	Black	Smoke
Black (TR-F)	•	
Smoke (TR-E)		•
Snow (TR-UFM)		•

\*Not specifiable.

<sup>1</sup>Plastic base option will default all metal trim to Black (TR-F).

### Features

- Back: Knit, mesh, or mesh back with upholstered back jacket.
- Seat: Standard upholstered with foam or optional foam with Technogel® Soft Lite gel insert.
- Seat Type: Standard adjustable [3"(76mm) range] or optional fixed.
- Base: Standard Plastic painted five-star base or optional painted aluminum or polished aluminum.
  - Plastic base available in Black.
  - Aluminum base available with painted Black, Metallic Silver, Metallic Champagne, or optional Polished Aluminum.
- Arms: Height-adjustable with soft arm caps. See matrix for default colors.
- Mechanism: Balanced 3-point tilt; standard tilt tension.
- Height adjustment: Pneumatic or low-position pneumatic.
- Optional Back Stop: Tilt stop in 6 positions.
- Optional Back Stop with Forward Tilt; Seat tilts 5° downward from initial position.
- Optional Asymmetrical Lumbar Adjustment: 4"(102mm) height adjustment; support level can be adjusted independently for right or left hand side of users body. Optional PAL Back System: Passive pelvic support.
- Casters: Hard or soft casters in black only.
- COM yardage / COL square footage:
  - Mesh back model: 0.75/10
  - Mesh back/upholstered back jacket: 1.5/18

**NOTE:** When specifying fabric or leather back jacket; must also specify mesh surface color for outside back.

Upcharge for mixed grade surfaces, refer to the electronic design and specification tools.

### To Order with Fabric or Leather Upholstered Back Jacket Specify:

1) Product number, including:

#### 1 Base/Caster Option:

##### Aluminum Base

- 1 Aluminum Base, Hard Caster, add **\$128.29** to list
- 2 Aluminum Base, Soft Caster, add **\$191.31** to list
- 3 Aluminum Low Base, Hard Caster, add **\$128.29** to list
- 4 Aluminum Low Base, Soft Caster, add **\$191.31** to list

##### Plastic Base

- 5 Plastic Std. Base, Hard Caster
- 6 Plastic Std. Base, Soft Caster, add **\$63.02** to list

- 2) Fabric surface and color (seat).
- 3) Mesh surface color (back).
- 4) Fabric surface and color (back jacket).
- 5) Trim color for frame. (Add **\$85.44** list for Snow.)
- 6) Trim color for base/arms. (Add **\$291.78** list for polished aluminum.)

### To Order with Knit or Mesh Back Specify:

1) Product number, including:

#### 1 Base/Caster Option:

##### Aluminum Base

- 1 Aluminum Base, Hard Caster, add **\$128.29** to list
- 2 Aluminum Base, Soft Caster, add **\$191.31** to list
- 3 Aluminum Low Base, Hard Caster, add **\$128.29** to list
- 4 Aluminum Low Base, Soft Caster, add **\$191.31** to list

##### Plastic Base

- 5 Plastic Std. Base, Hard Caster
- 6 Plastic Std. Base, Soft Caster, add **\$63.02** to list

- 2) Fabric surface and color (seat).
- 3) Knit or Mesh surface and color (back).
- 4) Trim color for frame. (Add **\$85.44** list for Snow.)
- 5) Trim color for base/arms. (Add **\$291.78** list for polished aluminum.)

# Zody

## Task Chair with Height Adjustable Arms

Upholstered		Fabric Grade										Leather	Leather
Foam Seat	Adjustments	Number	A	B	C	D	E	F	G	H	Grade A	Grade B	
<b>No Lumbar Adjustment - Mesh w/Plastic Base</b>													
Back Stop		SZT-20-401MA	\$1832.48	\$1884.90	\$1940.79	\$1968.76	\$1989.71	\$2040.41	\$2085.79	\$2209.86	\$2295.45	\$2523.02	
Back Stop/ Forward Tilt		SZT-20-404MA	1923.42	1975.84	2031.73	2059.70	2080.65	2131.35	2176.73	2300.80	2386.39	2613.96	
<b>No Lumbar Adjustment - Knit w/Plastic Base</b>													
Back Stop		SZT-20-401MA	\$2040.66	\$2093.08	\$2148.97	\$2176.94	\$2197.89	\$2248.59	\$2293.97	\$2418.04	\$2503.63	\$2731.20	
Back Stop/ Forward Tilt		SZT-20-404MA	2131.60	2184.02	2239.91	2267.88	2288.83	2339.53	2384.91	2508.98	2594.57	2822.14	
<b>No Lumbar Adjustment - Upholstered Back Jacket w/Plastic Base</b>													
Back Stop		SZT-22-401MA	\$2005.44	\$2110.28	\$2222.06	\$2278.00	\$2319.90	\$2421.30	\$2512.06	\$2760.20	\$2931.38	\$3386.52	
Back Stop/ Forward Tilt		SZT-22-404MA	2096.38	2201.22	2313.00	2368.94	2410.84	2512.24	2603.00	2851.14	3022.32	3477.46	
<b>Lumbar Adjustment - Mesh w/Plastic Base</b>													
Back Stop		SZT-20-411MA	\$1986.24	\$2038.66	\$2094.55	\$2122.52	\$2143.47	\$2194.17	\$2239.55	\$2363.62	\$2449.21	\$2676.78	
Back Stop/ Forward Tilt		SZT-20-414MA	2077.18	2129.60	2185.49	2213.46	2234.41	2285.11	2330.49	2454.56	2540.15	2767.72	
<b>Lumbar Adjustment - Knit w/Plastic Base</b>													
Back Stop		SZT-20-411MA	\$2194.42	\$2246.84	\$2302.73	\$2330.70	\$2351.65	\$2402.35	\$2447.73	\$2571.80	\$2657.39	\$2884.96	
Back Stop/ Forward Tilt		SZT-20-414MA	2285.36	2337.78	2393.67	2421.64	2442.59	2493.29	2538.67	2662.74	2748.33	2975.90	
<b>Lumbar Adjustment - Upholstered Back Jacket w/Plastic Base</b>													
Back Stop		SZT-22-411MA	\$2159.20	\$2264.04	\$2375.82	\$2431.76	\$2473.66	\$2575.06	\$2665.82	\$2913.96	\$3085.14	\$3540.28	
Back Stop/ Forward Tilt		SZT-22-414MA	2250.14	2354.98	2466.76	2522.70	2564.60	2666.00	2756.76	3004.90	3176.08	3631.22	
<b>PAL Back System - Mesh w/Plastic Base</b>													
Back Stop		SZT-20-421MA	\$2026.42	\$2078.84	\$2134.73	\$2162.70	\$2183.65	\$2234.35	\$2279.73	\$2403.80	\$2489.39	\$2716.96	
Back Stop/ Forward Tilt		SZT-20-424MA	2117.36	2169.78	2225.67	2253.64	2274.59	2325.29	2370.67	2494.74	2580.33	2807.90	
<b>PAL Back System - Knit w/Plastic Base</b>													
Back Stop		SZT-20-421MA	\$2234.60	\$2287.02	\$2342.91	\$2370.88	\$2391.83	\$2442.53	\$2487.91	\$2611.98	\$2697.57	\$2925.14	
Back Stop/ Forward Tilt		SZT-20-424MA	2325.54	2377.96	2433.85	2461.82	2482.77	2533.47	2578.85	2702.92	2788.51	3016.08	
<b>PAL Back System - Upholstered Back Jacket w/Plastic Base</b>													
Back Stop		SZT-22-421MA	\$2199.38	\$2304.22	\$2416.00	\$2471.94	\$2513.84	\$2615.24	\$2706.00	\$2954.14	\$3125.32	\$3580.46	
Back Stop/ Forward Tilt		SZT-22-424MA	2290.32	2395.16	2506.94	2562.88	2604.78	2706.18	2796.94	3045.08	3216.26	3671.40	

The following options require modification of the product number.

- Fixed seat
- Headrest
- Stain repellent
- Leather Seat with Mesh Back
- Leather Seat with Leather Upholstered Back Jacket
- Faux Leather Seat with Mesh Back
- Faux Leather Seat with Faux Leather Upholstered Back Jacket

- To specify, change the 10th digit from A to X; **Example:** SZT-20-402MX1
- To specify, change the 3rd digit from a T to an E; **Example:** SZE-22-402MA1 with headrest (add \$90.84 list)
- To specify, add P to end of the product number (add \$54.18 list)
- To specify, change the 4th digit to 1 and 5th digit to 0; **Example:** SZT-10-402MA5
- To specify, change the 4th digit to 1 and 5th digit to 1; **Example:** SZT-11-402MA5
- To specify, change the 4th digit to 3; **Example:** SZT-30-402MA5
- To specify, change the 4th and 5th digits to 33; **Example:** SZT-33-402MA5

**NOTE:** For available fabrics, refer to [surfaces.haworth.com](https://surfaces.haworth.com).

# Zody

## Task Chair with Height Adjustable Arms

Upholstered Gel Insert Seat	Adjustments	Number	Fabric Grade								Leather Grade A	Leather Grade B
			A	B	C	D	E	F	G	H		
<b>No Lumbar Adjustment - Mesh w/Plastic Base</b>												
	Back Stop	SZT-20-401EA	\$1977.52	\$2029.94	\$2085.83	\$2113.80	\$2134.75	\$2185.45	\$2230.83	\$2354.90	\$2440.49	\$2668.06
	Back Stop/ Forward Tilt	SZT-20-404EA	2068.46	2120.88	2176.77	2204.74	2225.69	2276.39	2321.77	2445.84	2531.43	2759.00
<b>No Lumbar Adjustment - Knit w/Plastic Base</b>												
	Back Stop	SZT-20-401EA	\$2185.70	\$2238.12	\$2294.01	\$2321.98	\$2342.93	\$2393.63	\$2439.01	\$2563.08	\$2648.67	\$2876.24
	Back Stop/ Forward Tilt	SZT-20-404EA	2276.64	2329.06	2384.95	2412.92	2433.87	2484.57	2529.95	2654.02	2739.61	2967.18
<b>No Lumbar Adjustment - Upholstered Back Jacket w/Plastic Base</b>												
	Back Stop	SZT-22-401EA	\$2150.48	\$2255.32	\$2367.10	\$2423.04	\$2464.94	\$2566.34	\$2657.10	\$2905.24	\$3076.42	\$3531.56
	Back Stop/ Forward Tilt	SZT-22-404EA	2241.42	2346.26	2458.04	2513.98	2555.88	2657.28	2748.04	2996.18	3167.36	3622.50
<b>Lumbar Adjustment - Mesh w/Plastic Base</b>												
	Back Stop	SZT-20-411EA	\$2131.28	\$2183.70	\$2239.59	\$2267.56	\$2288.51	\$2339.21	\$2384.59	\$2508.66	\$2594.25	\$2821.82
	Back Stop/ Forward Tilt	SZT-20-414EA	2222.22	2274.64	2330.53	2358.50	2379.45	2430.15	2475.53	2599.60	2685.19	2912.76
<b>Lumbar Adjustment - Knit w/Plastic Base</b>												
	Back Stop	SZT-20-411EA	\$2339.46	\$2391.88	\$2447.77	\$2475.74	\$2496.69	\$2547.39	\$2592.77	\$2716.84	\$2802.43	\$3030.00
	Back Stop/ Forward Tilt	SZT-20-414EA	2430.40	2482.82	2538.71	2566.68	2587.63	2638.33	2683.71	2807.78	2893.37	3120.94
<b>Lumbar Adjustment - Upholstered Back Jacket w/Plastic Base</b>												
	Back Stop	SZT-22-411EA	\$2304.24	\$2409.08	\$2520.86	\$2576.80	\$2618.70	\$2720.10	\$2810.86	\$3059.00	\$3230.18	\$3685.32
	Back Stop/ Forward Tilt	SZT-22-414EA	2395.18	2500.02	2611.80	2667.74	2709.64	2811.04	2901.80	3149.94	3321.12	3776.26
<b>PAL Back System - Mesh w/Plastic Base</b>												
	Back Stop	SZT-20-421EA	\$2171.46	\$2223.88	\$2279.77	\$2307.74	\$2328.69	\$2379.39	\$2424.77	\$2548.84	\$2634.43	\$2862.00
	Back Stop/ Forward Tilt	SZT-20-424EA	2262.40	2314.82	2370.71	2398.68	2419.63	2470.33	2515.71	2639.78	2725.37	2952.94
<b>PAL Back System - Knit w/Plastic Base</b>												
	Back Stop	SZT-20-421EA	\$2379.64	\$2432.06	\$2487.95	\$2515.92	\$2536.87	\$2587.57	\$2632.95	\$2757.02	\$2842.61	\$3070.18
	Back Stop/ Forward Tilt	SZT-20-424EA	2470.58	2523.00	2578.89	2606.86	2627.81	2678.51	2723.89	2847.96	2933.55	3161.12
<b>PAL Back System - Upholstered Back Jacket w/Plastic Base</b>												
	Back Stop	SZT-22-421EA	\$2344.42	\$2449.26	\$2561.04	\$2616.98	\$2658.88	\$2760.28	\$2851.04	\$3099.18	\$3270.36	\$3725.50
	Back Stop/ Forward Tilt	SZT-22-424EA	2435.36	2540.20	2651.98	2707.92	2749.82	2851.22	2941.98	3190.12	3361.30	3816.44

The following options require modification of the product number.

- Fixed seat
- Headrest
- Stain repellent
- Leather Seat with Mesh Back
- Leather Seat with Leather Upholstered Back Jacket
- Faux Leather Seat with Mesh Back
- Faux Leather Seat with Faux Leather Upholstered Back Jacket

- To specify, change the 10th digit from A to X; **Example:** SZT-20-402EX1
- To specify, change the 3rd digit from a T to an E; **Example:** SZE-22-402EA1 with headrest (add \$90.84 list)
- To specify, add **P** to end of the product number (add \$54.18 list)
- To specify, change the 4th digit to **1** and 5th digit to **0**; **Example:** SZT-10-402EA5
- To specify, change the 4th digit to **1** and 5th digit to **1**; **Example:** SZT-11-402EA5
- To specify, change the 4th digit to **3**; **Example:** SZT-30-402EA5
- To specify, change the 4th and 5th digits to **33**; **Example:** SZT-33-402EA5

**NOTE:** For available fabrics, refer to [surfaces.haworth.com](http://surfaces.haworth.com).

This page intentionally blank



# Zody

## Task Chair with Fixed Arms



SZT-20-102MA1

### Dimensions\*

- \*SH: 16-21"  
(406mm-533mm)
- H: 38-43"(965mm-1092mm)
- D: 29"(737mm)
- W: 29"(737mm)
- \*SW: 19.25"(489mm)
- \*SD: 16-19"(406mm-483mm)
- \*AH: 9"(229mm)
- Low position seat height:  
14-17"(356mm-432mm)

\* All measurements taken with the BIFMA chair measuring device.

Trim Color <sup>1</sup>	Arm Cap & Headrest Color*	
	Black	Smoke
Black (TR-F)	•	
Smoke (TR-E)		•
Snow (TR-UFM)		•

\*Not specifiable.

<sup>1</sup>Plastic base option will default all metal trim to Black (TR-F).

### Features

- Back: Knit, mesh, or mesh back with upholstered back jacket.
- Seat: Standard upholstered with foam or optional foam with Technogel<sup>®</sup> Soft Lite gel insert.
- Seat Type: Standard adjustable [3"(76mm) range] or optional fixed.
- Base: Standard Plastic painted five-star base or optional painted aluminum or polished aluminum. –Plastic base available in Black. –Aluminum base available with painted Black, Metallic Silver, Metallic Champagne, or optional Polished Aluminum.
- Arms: Fixed with soft arm caps. See matrix for default colors.
- Mechanism: Balanced 3-point tilt; standard tilt tension.
- Height adjustment: Pneumatic or low-position pneumatic.
- Optional Back Stop: Tilt stop in 6 positions.
- Optional Back Stop with Forward Tilt; Seat tilts 5° from initial position.
- Optional Asymmetrical Lumbar Adjustment: 4"(102mm) height adjustment; support level can be adjusted independently for right or left hand side of users body. Optional PAL Back System: Passive pelvic support.
- Casters: Hard or soft casters in black only.
- COM yardage / COL square footage:  
Mesh back model: 0.75/10  
Mesh back/upholstered back jacket: 1.5/18

**NOTE:** When specifying fabric or leather back jacket; must also specify mesh surface color for outside back.

Upcharge for mixed grade surfaces, refer to the electronic design and specification tools.

### To Order with Fabric or Leather Upholstered Back Jacket Specify:

1) Product number, including:

#### 1 Base/Caster Option:

##### Aluminum Base

- 1 Aluminum Base, Hard Caster, add **\$128.29** to list
- 2 Aluminum Base, Soft Caster, add **\$191.31** to list
- 3 Aluminum Low Base, Hard Caster, add **\$128.29** to list
- 4 Aluminum Low Base, Soft Caster, add **\$191.31** to list

##### Plastic Base

- 5 Plastic Std. Base, Hard Caster
- 6 Plastic Std. Base, Soft Caster, add **\$63.02** to list

- 2) Fabric surface and color (seat).
- 3) Mesh surface color (back).
- 4) Fabric surface and color (back jacket).
- 5) Trim color for frame. (Add **\$85.44** list for Snow.)
- 6) Trim color for base/arms. (Add **\$291.78** list for polished aluminum.)

### To Order with Knit or Mesh Back Specify:

1) Product number, including:

#### 1 Base/Caster Option:

##### Aluminum Base

- 1 Aluminum Base, Hard Caster, add **\$128.29** to list
- 2 Aluminum Base, Soft Caster, add **\$191.31** to list
- 3 Aluminum Low Base, Hard Caster, add **\$128.29** to list
- 4 Aluminum Low Base, Soft Caster, add **\$191.31** to list

##### Plastic Base

- 5 Plastic Std. Base, Hard Caster
- 6 Plastic Std. Base, Soft Caster, add **\$63.02** to list

- 2) Fabric surface and color (seat).
- 3) Knit or Mesh surface and color (back).
- 4) Trim color for frame. (Add **\$85.44** list for Snow.)
- 5) Trim color for base/arms. (Add **\$291.78** list for polished aluminum.)

# Zody

## Task Chair with Fixed Arms

Upholstered			Fabric Grade								Leather	Leather
Foam Seat	Adjustments	Number	A	B	C	D	E	F	G	H	Grade A	Grade B
<b>No Lumbar Adjustment - Mesh Back w/Plastic Base</b>												
Back Stop		SZT-20-101MA	\$1713.69	\$1766.11	\$1822.00	\$1849.97	\$1870.92	\$1921.62	\$1967.00	\$2091.07	\$2176.66	\$2404.23
Back Stop/ Forward Tilt		SZT-20-104MA	1804.63	1857.05	1912.94	1940.91	1961.86	2012.56	2057.94	2182.01	2267.60	2495.17
<b>No Lumbar Adjustment - Knit w/Plastic Base</b>												
Back Stop		SZT-20-101MA	\$1921.87	\$1974.29	\$2030.18	\$2058.15	\$2079.10	\$2129.80	\$2175.18	\$2299.25	\$2384.84	\$2612.41
Back Stop/ Forward Tilt		SZT-20-104MA	2012.81	2065.23	2121.12	2149.09	2170.04	2220.74	2266.12	2390.19	2475.78	2703.35
<b>No Lumbar Adjustment - Upholstered Back Jacket w/Plastic Base</b>												
Back Stop		SZT-22-101MA	\$1886.65	\$1991.49	\$2103.27	\$2159.21	\$2201.11	\$2302.51	\$2393.27	\$2641.41	\$2812.59	\$3267.73
Back Stop/ Forward Tilt		SZT-22-104MA	1977.59	2082.43	2194.21	2250.15	2292.05	2393.45	2484.21	2732.35	2903.53	3358.67
<b>Lumbar Adjustment - Mesh Back w/Plastic Base</b>												
Back Stop		SZT-20-111MA	\$1867.45	\$1919.87	\$1975.76	\$2003.73	\$2024.68	\$2075.38	\$2120.76	\$2244.83	\$2330.42	\$2557.99
Back Stop/ Forward Tilt		SZT-20-114MA	1958.39	2010.81	2066.70	2094.67	2115.62	2166.32	2211.70	2335.77	2421.36	2648.93
<b>Lumbar Adjustment - Knit Back w/Plastic Base</b>												
Back Stop		SZT-20-111MA	\$2075.63	\$2128.05	\$2183.94	\$2211.91	\$2232.86	\$2283.56	\$2328.94	\$2453.01	\$2538.60	\$2766.17
Back Stop/ Forward Tilt		SZT-20-114MA	2166.57	2218.99	2274.88	2302.85	2323.80	2374.50	2419.88	2543.95	2629.54	2857.11
<b>Lumbar Adjustment - Upholstered Back Jacket w/Plastic Base</b>												
Back Stop		SZT-22-111MA	\$2040.41	\$2145.25	\$2257.03	\$2312.97	\$2354.87	\$2456.27	\$2547.03	\$2795.17	\$2966.35	\$3421.49
Back Stop/ Forward Tilt		SZT-22-114MA	2131.35	2236.19	2347.97	2403.91	2445.81	2547.21	2637.97	2886.11	3057.29	3512.43
<b>PAL Back System - Mesh Back w/Plastic Base</b>												
Back Stop		SZT-20-121MA	\$1907.63	\$1960.05	\$2015.94	\$2043.91	\$2064.86	\$2115.56	\$2160.94	\$2285.01	\$2370.60	\$2598.17
Back Stop/ Forward Tilt		SZT-20-124MA	1998.57	2050.99	2106.88	2134.85	2155.80	2206.50	2251.88	2375.95	2461.54	2689.11
<b>PAL Back System - Knit Back w/Plastic Base</b>												
Back Stop		SZT-20-121MA	2115.81	2168.23	2224.12	2252.09	2273.04	2323.74	2369.12	2493.19	2578.78	2806.35
Back Stop/ Forward Tilt		SZT-20-124MA	2206.75	2259.17	2315.06	2343.03	2363.98	2414.68	2460.06	2584.13	2669.72	2897.29
<b>PAL Back System - Upholstered Back Jacket w/Plastic Base</b>												
Back Stop		SZT-22-121MA	\$2080.59	\$2185.43	\$2297.21	\$2353.15	\$2395.05	\$2496.45	\$2587.21	\$2835.35	\$3006.53	\$3461.67
Back Stop/ Forward Tilt		SZT-22-124MA	2171.53	2276.37	2388.15	2444.09	2485.99	2587.39	2678.15	2926.29	3097.47	3552.61

The following options require modification of the product number.

- Fixed seat
- Headrest
- Stain repellent
- Leather Seat with Mesh Back
- Leather Seat with Leather Upholstered Back Jacket
- Faux Leather Seat with Mesh Back
- Faux Leather Seat with Faux Leather Upholstered Back Jacket

- To specify, change the 10th digit from A to X; **Example:** SZT-20-102MX1
- To specify, change the 3rd digit from a T to an E; **Example:** SZE-22-102MA1 with headrest (add \$90.84 list)
- To specify, add P to end of the product number (add \$54.18 list)
- To specify, change the 4th digit to 1 and 5th digit to 0; **Example:** SZT-10-102MA5
- To specify, change the 4th digit to 1 and 5th digit to 1; **Example:** SZT-11-102MA5
- To specify, change the 4th digit to 3; **Example:** SZT-30-102MA5
- To specify, change the 4th and 5th digits to 33; **Example:** SZT-33-102MA5

**NOTE:** For available fabrics, refer to [surfaces.haworth.com](https://surfaces.haworth.com).

# Zody

## Task Chair with Fixed Arms

Upholstered Gel Insert Seat	Adjustments	Number	Fabric Grade		C	D	E	F	G	H	Leather Grade A	Leather Grade B
			A	B								
<b>No Lumbar Adjustment - Mesh Back w/Plastic Base</b>												
	Back Stop	SZT-20-101EA	\$1858.73	\$1911.15	\$1967.04	\$1995.01	\$2015.96	\$2066.66	\$2112.04	\$2236.11	\$2321.70	\$2549.27
	Back Stop/ Forward Tilt	SZT-20-104EA	1949.67	2002.09	2057.98	2085.95	2106.90	2157.60	2202.98	2327.05	2412.64	2640.21
<b>No Lumbar Adjustment - Knit Back w/Plastic Base</b>												
	Back Stop	SZT-20-101EA	\$2066.91	\$2119.33	\$2175.22	\$2203.19	\$2224.14	\$2274.84	\$2320.22	\$2444.29	\$2529.88	\$2757.45
	Back Stop/ Forward Tilt	SZT-20-104EA	2157.85	2210.27	2266.16	2294.13	2315.08	2365.78	2411.16	2535.23	2620.82	2848.39
<b>No Lumbar Adjustment - Upholstered Back Jacket w/Plastic Base</b>												
	Back Stop	SZT-22-101EA	\$2031.69	\$2136.53	\$2248.31	\$2304.25	\$2346.15	\$2447.55	\$2538.31	\$2786.45	\$2957.63	\$3412.77
	Back Stop/ Forward Tilt	SZT-22-104EA	2122.63	2227.47	2339.25	2395.19	2437.09	2538.49	2629.25	2877.39	3048.57	3503.71
<b>Lumbar Adjustment - Mesh Back w/Plastic Base</b>												
	Back Stop	SZT-20-111EA	\$2012.49	\$2064.91	\$2120.80	\$2148.77	\$2169.72	\$2220.42	\$2265.80	\$2389.87	\$2475.46	\$2703.03
	Back Stop/ Forward Tilt	SZT-20-114EA	2103.43	2155.85	2211.74	2239.71	2260.66	2311.36	2356.74	2480.81	2566.40	2793.97
<b>Lumbar Adjustment - Knit Back w/Plastic Base</b>												
	Back Stop	SZT-20-111EA	\$2220.67	\$2273.09	\$2328.98	\$2356.95	\$2377.90	\$2428.60	\$2473.98	\$2598.05	\$2683.64	\$2911.21
	Back Stop/ Forward Tilt	SZT-20-114EA	2311.61	2364.03	2419.92	2447.89	2468.84	2519.54	2564.92	2688.99	2774.58	3002.15
<b>Lumbar Adjustment - Upholstered Back Jacket w/Plastic Base</b>												
	Back Stop	SZT-22-111EA	\$2185.45	\$2290.29	\$2402.07	\$2458.01	\$2499.91	\$2601.31	\$2692.07	\$2940.21	\$3111.39	\$3566.53
	Back Stop/ Forward Tilt	SZT-22-114EA	2276.39	2381.23	2493.01	2548.95	2590.85	2692.25	2783.01	3031.15	3202.33	3657.47
<b>PAL Back System - Mesh Back w/Plastic Base</b>												
	Back Stop	SZT-20-121EA	\$2052.67	\$2105.09	\$2160.98	\$2188.95	\$2209.90	\$2260.60	\$2305.98	\$2430.05	\$2515.64	\$2743.21
	Back Stop/ Forward Tilt	SZT-20-124EA	2143.61	2196.03	2251.92	2279.89	2300.84	2351.54	2396.92	2520.99	2606.58	2834.15
<b>PAL Back System - Knit Back w/Plastic Base</b>												
	Back Stop	SZT-20-121EA	\$2260.85	\$2313.27	\$2369.16	\$2397.13	\$2418.08	\$2468.78	\$2514.16	\$2638.23	\$2723.82	\$2951.39
	Back Stop/ Forward Tilt	SZT-20-124EA	2351.79	2404.21	2460.10	2488.07	2509.02	2559.72	2605.10	2729.17	2814.76	3042.33
<b>PAL Back System - Upholstered Back Jacket w/Plastic Base</b>												
	Back Stop	SZT-22-121EA	\$2225.63	\$2330.47	\$2442.25	\$2498.19	\$2540.09	\$2641.49	\$2732.25	\$2980.39	\$3151.57	\$3606.71
	Back Stop/ Forward Tilt	SZT-22-124EA	2316.57	2421.41	2533.19	2589.13	2631.03	2732.43	2823.19	3071.33	3242.51	3697.65

The following options require modification of the product number.

- Fixed seat
- Headrest
- Stain repellent
- Leather Seat with Mesh Back
- Leather Seat with Leather Upholstered Back Jacket
- Faux Leather Seat with Mesh Back
- Faux Leather Seat with Faux Leather Upholstered Back Jacket

- To specify, change the 10th digit from A to X; **Example:** SZT-20-102EX1
  - To specify, change the 3rd digit from a T to an E; **Example:** SZE-22-102EA1 with headrest (add \$90.84 list)
  - To specify, add P to end of the product number (add \$54.18 list)
  - To specify, change the 4th digit to 1 and 5th digit to 0; **Example:** SZT-10-102EA5
  - To specify, change the 4th digit to 1 and 5th digit to 1; **Example:** SZT-11-102EA5
  - To specify, change the 4th digit to 3; **Example:** SZT-30-102EA5
  - To specify, change the 4th and 5th digits to 33; **Example:** SZT-33-102EA5
- NOTE:** For available fabrics, refer to [surfaces.haworth.com](https://surfaces.haworth.com).

This page intentionally blank

# Zody

## Task Chair without Arms



SZT-20-002MA1

### Dimensions\*

- \*SH: 16-21" (406mm-533mm)
- H: 38-43" (965mm-1092mm)
- D: 29" (737mm)
- W: 29" (737mm)
- \*SW: 19.25" (489mm)
- \*SD: 16-19" (406mm-483mm)

Low position seat height:  
14-17" (356mm-432mm)

\* All measurements taken with the BIFMA chair measuring device.

Trim Color <sup>1</sup>	Headrest Color*	
	Black	Smoke
Black (TR-F)	•	
Smoke (TR-E)		•
Snow (TR-UFM)		•

\*Not specifiable.

<sup>1</sup>Plastic base option will default all metal trim to Black (TR-F).

### Features

- Back: Knit, mesh, or mesh back with upholstered back jacket.
- Seat: Standard upholstered with foam or optional foam with Technogel<sup>®</sup> Soft Lite gel insert.
- Seat Type: Standard adjustable [3" (76mm) range] or optional fixed.
- Base: Standard Plastic painted five-star base or optional painted aluminum or polished aluminum. –Plastic base available in Black. –Aluminum base available with painted Black, Metallic Silver, Metallic Champagne, or optional Polished Aluminum.
- Mechanism: Balanced 3-point tilt; standard tilt tension.
- Height adjustment: Pneumatic or low-position pneumatic.
- Optional Back Stop: Tilt stop in 6 positions.
- Optional Back Stop with Forward Tilt; Seat tilts 5° downward from initial position.
- Optional Asymmetrical Lumbar Adjustment: 4" (102mm) height adjustment; support level can be adjusted independently for right or left hand side of users body. Optional PAL Back System: Passive pelvic support
- Casters: Hard or soft casters in black only.
- COM yardage / COL square footage:  
Mesh back model: 0.75/10  
Mesh back/upholstered back jacket: 1.5/18

**NOTE:** When specifying fabric or leather back jacket; must also specify mesh surface color for outside back.

Upcharge for mixed grade surfaces, refer to the electronic design and specification tools.

### To Order with Fabric or Leather Upholstered Back Jacket Specify:

1) Product number, including:

#### 1 Base/Caster Option:

##### Aluminum Base

- 1 Aluminum Base, Hard Caster, add **\$128.29** to list
- 2 Aluminum Base, Soft Caster, add **\$191.31** to list
- 3 Aluminum Low Base, Hard Caster, add **\$128.29** to list
- 4 Aluminum Low Base, Soft Caster, add **\$191.31** to list

##### Plastic Base

- 5 Plastic Std. Base, Hard Caster
- 6 Plastic Std. Base, Soft Caster, add **\$63.02** to list

- 2) Fabric surface and color (seat).
- 3) Mesh surface color (back).
- 4) Fabric surface and color (back jacket).
- 5) Trim color for frame. (Add **\$85.44** list for Snow.)
- 6) Trim color for base. (Add **\$291.78** list for polished aluminum.)

### To Order with Knit or Mesh Back Specify:

1) Product number, including:

#### 1 Base/Caster Option:

##### Aluminum Base

- 1 Aluminum Base, Hard Caster, add **\$128.29** to list
- 2 Aluminum Base, Soft Caster, add **\$191.31** to list
- 3 Aluminum Low Base, Hard Caster, add **\$128.29** to list
- 4 Aluminum Low Base, Soft Caster, add **\$191.31** to list

##### Plastic Base

- 5 Plastic Std. Base, Hard Caster
- 6 Plastic Std. Base, Soft Caster, add **\$63.02** to list

- 2) Fabric surface and color (seat).
- 3) Knit or Mesh surface and color (back).
- 4) Trim color for frame. (Add **\$85.44** list for Snow.)
- 5) Trim color for base. (Add **\$291.78** list for polished aluminum.)

# Zody

## Task Chair without Arms

Upholstered		Fabric Grade										Leather	Leather
Foam Seat	Adjustments	Number	①	A	B	C	D	E	F	G	H	Grade A	Grade B
<b>No Lumbar Adjustment - Mesh Back w/Plastic Base</b>													
	Back Stop	SZT-20-001MA		\$1519.75	\$1572.17	\$1628.06	\$1656.03	\$1676.98	\$1727.68	\$1773.06	\$1897.13	\$1982.72	\$2210.29
	Back Stop/ Forward Tilt	SZT-20-004MA		1610.69	1663.11	1719.00	1746.97	1767.92	1818.62	1864.00	1988.07	2073.66	2301.23
<b>No Lumbar Adjustment - Knit Back w/Plastic Base</b>													
	Back Stop	SZT-20-001MA		\$1727.93	\$1780.35	\$1836.24	\$1864.21	\$1885.16	\$1935.86	\$1981.24	\$2105.31	\$2190.90	\$2418.47
	Back Stop/ Forward Tilt	SZT-20-004MA		1818.87	1871.29	1927.18	1955.15	1976.10	2026.80	2072.18	2196.25	2281.84	2509.41
<b>No Lumbar Adjustment - Upholstered Back Jacket w/Plastic Base</b>													
	Back Stop	SZT-22-001MA		\$1692.71	\$1797.55	\$1909.33	\$1965.27	\$2007.17	\$2108.57	\$2199.33	\$2447.47	\$2618.65	\$3073.79
	Back Stop/ Forward Tilt	SZT-22-004MA		1783.65	1888.49	2000.27	2056.21	2098.11	2199.51	2290.27	2538.41	2709.59	3164.73
<b>Lumbar Adjustment - Mesh Back w/Plastic Base</b>													
	Back Stop	SZT-20-011MA		\$1673.51	\$1725.93	\$1781.82	\$1809.79	\$1830.74	\$1881.44	\$1926.82	\$2050.89	\$2136.48	\$2364.05
	Back Stop/ Forward Tilt	SZT-20-014MA		1764.45	1816.87	1872.76	1900.73	1921.68	1972.38	2017.76	2141.83	2227.42	2454.99
<b>Lumbar Adjustment - Knit Back w/Plastic Base</b>													
	Back Stop	SZT-20-011MA		\$1881.69	\$1934.11	\$1990.00	\$2017.97	\$2038.92	\$2089.62	\$2135.00	\$2259.07	\$2344.66	\$2572.23
	Back Stop/ Forward Tilt	SZT-20-014MA		1972.63	2025.05	2080.94	2108.91	2129.86	2180.56	2225.94	2350.01	2435.60	2663.17
<b>Lumbar Adjustment - Upholstered Back Jacket w/Plastic Base</b>													
	Back Stop	SZT-22-011MA		\$1846.47	\$1951.31	\$2063.09	\$2119.03	\$2160.93	\$2262.33	\$2353.09	\$2601.23	\$2772.41	\$3227.55
	Back Stop/ Forward Tilt	SZT-22-014MA		1937.41	2042.25	2154.03	2209.97	2251.87	2353.27	2444.03	2692.17	2863.35	3318.49
<b>PAL Back System - Mesh Back w/Plastic Base</b>													
	Back Stop	SZT-20-021MA		\$1713.69	\$1766.11	\$1822.00	\$1849.97	\$1870.92	\$1921.62	\$1967.00	\$2091.07	\$2176.66	\$2404.23
	Back Stop/ Forward Tilt	SZT-20-024MA		1804.63	1857.05	1912.94	1940.91	1961.86	2012.56	2057.94	2182.01	2267.60	2495.17
<b>PAL Back System - Knit Back w/Plastic Base</b>													
	Back Stop	SZT-20-021MA		\$1921.87	\$1974.29	\$2030.18	\$2058.15	\$2079.10	\$2129.80	\$2175.18	\$2299.25	\$2384.84	\$2612.41
	Back Stop/ Forward Tilt	SZT-20-024MA		2012.81	2065.23	2121.12	2149.09	2170.04	2220.74	2266.12	2390.19	2475.78	2703.35
<b>PAL Back System - Upholstered Back Jacket w/Plastic Base</b>													
	Back Stop	SZT-22-021MA		\$1886.65	\$1991.49	\$2103.27	\$2159.21	\$2201.11	\$2302.51	\$2393.27	\$2641.41	\$2812.59	\$3267.73
	Back Stop/ Forward Tilt	SZT-22-024MA		1977.59	2082.43	2194.21	2250.15	2292.05	2393.45	2484.21	2732.35	2903.53	3358.67

The following options require modification of the product number.

- Fixed seat
- Headrest
- Stain repellent
- Leather Seat with Mesh Back
- Leather Seat with Leather Upholstered Back Jacket
- Faux Leather Seat with Mesh Back
- Faux Leather Seat with Faux Leather Upholstered Back Jacket

- To specify, change the 10th digit from A to X; **Example:** SZT-20-002MX1
- To specify, change the 3rd digit from a T to an E; **Example:** SZE-22-002MA1 with headrest (add \$90.84 list)
- To specify, add P to end of the product number (add \$54.18 list)
- To specify, change the 4th digit to 1 and 5th digit to 0; **Example:** SZT-10-002MA5
- To specify, change the 4th digit to 1 and 5th digit to 1; **Example:** SZT-11-002MA5
- To specify, change the 4th digit to 3; **Example:** SZT-30-002MA5
- To specify, change the 4th and 5th digits to 33; **Example:** SZT-33-002MA5

**NOTE:** For available fabrics, refer to [surfaces.haworth.com](https://surfaces.haworth.com).

# Zody

## Task Chair without Arms

Upholstered Gel Insert Seat	Adjustments	Number	①	Fabric Grade								Leather Grade A	Leather Grade B
				A	B	C	D	E	F	G	H		
<b>No Lumbar Adjustment - Mesh Back w/Plastic Base</b>													
	Back Stop	SZT-20-001EA		\$1664.79	\$1717.21	\$1773.10	\$1801.07	\$1822.02	\$1872.72	\$1918.10	\$2042.17	\$2127.76	\$2355.33
	Back Stop/ Forward Tilt	SZT-20-004EA		1755.73	1808.15	1864.04	1892.01	1912.96	1963.66	2009.04	2133.11	2218.70	2446.27
<b>No Lumbar Adjustment - Knit Back w/Plastic Base</b>													
	Back Stop	SZT-20-001EA		\$1872.97	\$1925.39	\$1981.28	\$2009.25	\$2030.20	\$2080.90	\$2126.28	\$2250.35	\$2335.94	\$2563.51
	Back Stop/ Forward Tilt	SZT-20-004EA		1963.91	2016.33	2072.22	2100.19	2121.14	2171.84	2217.22	2341.29	2426.88	2654.45
<b>No Lumbar Adjustment - Upholstered Back Jacket w/Plastic Base</b>													
	Back Stop	SZT-22-001EA		\$1837.75	\$1942.59	\$2054.37	\$2110.31	\$2152.21	\$2253.61	\$2344.37	\$2592.51	\$2763.69	\$3218.83
	Back Stop/ Forward Tilt	SZT-22-004EA		1928.69	2033.53	2145.31	2201.25	2243.15	2344.55	2435.31	2683.45	2854.63	3309.77
<b>Lumbar Adjustment - Mesh Back w/Plastic Base</b>													
	Back Stop	SZT-20-011EA		\$1818.55	\$1870.97	\$1926.86	\$1954.83	\$1975.78	\$2026.48	\$2071.86	\$2195.93	\$2281.52	\$2509.09
	Back Stop/ Forward Tilt	SZT-20-014EA		1909.49	1961.91	2017.80	2045.77	2066.72	2117.42	2162.80	2286.87	2372.46	2600.03
<b>Lumbar Adjustment - Knit Back w/Plastic Base</b>													
	Back Stop	SZT-20-011EA		\$2026.73	\$2079.15	\$2135.04	\$2163.01	\$2183.96	\$2234.66	\$2280.04	\$2404.11	\$2489.70	\$2717.27
	Back Stop/ Forward Tilt	SZT-20-014EA		2117.67	2170.09	2225.98	2253.95	2274.90	2325.60	2370.98	2495.05	2580.64	2808.21
<b>Lumbar Adjustment - Upholstered Back Jacket w/Plastic Base</b>													
	Back Stop	SZT-22-011EA		\$1991.51	\$2096.35	\$2208.13	\$2264.07	\$2305.97	\$2407.37	\$2498.13	\$2746.27	\$2917.45	\$3372.59
	Back Stop/ Forward Tilt	SZT-22-014EA		2082.45	2187.29	2299.07	2355.01	2396.91	2498.31	2589.07	2837.21	3008.39	3463.53
<b>PAL Back System - Mesh Back w/Plastic Base</b>													
	Back Stop	SZT-20-021EA		\$1858.73	\$1911.15	\$1967.04	\$1995.01	\$2015.96	\$2066.66	\$2112.04	\$2236.11	\$2321.70	\$2549.27
	Back Stop/ Forward Tilt	SZT-20-024EA		1949.67	2002.09	2057.98	2085.95	2106.90	2157.60	2202.98	2327.05	2412.64	2640.21
<b>PAL Back System - Knit Back w/Plastic Base</b>													
	Back Stop	SZT-20-021EA		\$2066.91	\$2119.33	\$2175.22	\$2203.19	\$2224.14	\$2274.84	\$2320.22	\$2444.29	\$2529.88	\$2757.45
	Back Stop/ Forward Tilt	SZT-20-024EA		2157.85	2210.27	2266.16	2294.13	2315.08	2365.78	2411.16	2535.23	2620.82	2848.39
<b>PAL Back System - Upholstered Back Jacket w/Plastic Base</b>													
	Back Stop	SZT-22-021EA		\$2031.69	\$2136.53	\$2248.31	\$2304.25	\$2346.15	\$2447.55	\$2538.31	\$2786.45	\$2957.63	\$3412.77
	Back Stop/ Forward Tilt	SZT-22-024EA		2122.63	2227.47	2339.25	2395.19	2437.09	2538.49	2629.25	2877.39	3048.57	3503.71

The following options require modification of the product number.

- Fixed seat
- Headrest
- Stain repellent
- Leather Seat with Mesh Back
- Leather Seat with Leather Upholstered Back Jacket
- Faux Leather Seat with Mesh Back
- Faux Leather Seat with Faux Leather Upholstered Back Jacket

- To specify, change the 10th digit from A to X; **Example:** SZT-20-002EX1
  - To specify, change the 3rd digit from a T to an E; **Example:** SZE-22-002EA1 with headrest (add \$90.84 list)
  - To specify, add P to end of the product number (add \$54.18 list)
  - To specify, change the 4th digit to 1 and 5th digit to 0; **Example:** SZT-10-002EA5
  - To specify, change the 4th digit to 1 and 5th digit to 1; **Example:** SZT-11-002EA5
  - To specify, change the 4th digit to 3; **Example:** SZT-30-002EA5
  - To specify, change the 4th and 5th digits to 33; **Example:** SZT-33-002EA5
- NOTE:** For available fabrics, refer to [surfaces.haworth.com](https://surfaces.haworth.com).

This page intentionally blank



# Zody

## Task Stool with 4D Arms



SZTC-20-702MA1

### Dimensions\*

- \*SH: 21.5-29" (546mm-737mm)
- H: 43-51"(1092mm-1295mm)
- D: 29"(737mm)
- W: 29"(737mm)
- \*SW: 19.25"(489mm)
- \*SD: 16-19"(406mm-483mm)
- \*AH: 6.8-10.8" (173mm-274mm)

\* All measurements taken with the BIFMA chair measuring device.

Trim Color <sup>1</sup>	Arm Cap Color*	
	Black	Smoke
Black (TR-F)	•	
Smoke (TR-E)		•
Snow (TR-UFM)		•

\*Not specifiable.

<sup>1</sup>Plastic base option will default all metal trim to Black (TR-F).

### Features

- Back: Knit, mesh, or mesh back with upholstered back jacket.
- Seat: Standard upholstered with foam or optional foam with Technogel<sup>®</sup> Soft Lite gel insert.
- Seat Type: Standard adjustable [3"(76mm) range] or optional fixed.
- Base: Standard Plastic painted five-star base or optional painted aluminum or polished aluminum. –Plastic base available in Black. –Aluminum base available with painted Black, Metallic Silver, Metallic Champagne, or optional Polished Aluminum.
- Arms: 4D with soft arm caps. See matrix for default colors.
- Mechanism: Balanced 3-point tilt; standard tilt tension.
- Height adjustment: Pneumatic.
- Optional Back Stop: Tilt stop in 6 positions.
- Optional Asymmetrical Lumbar Adjustment: 4"(102mm) height adjustment; support level can be adjusted independently for right or left hand side of users body. Optional PAL Back System: Passive pelvic support.
- Casters: Hard or soft casters in black only.
- COM yardage / COL square footage:  
Mesh back model: .75/10  
Mesh back/upholstered back jacket: 1.5/18

**NOTE:** When specifying fabric or leather back jacket; must also specify mesh surface color for outside back.

Upcharge for mixed grade surfaces, refer to the electronic design and specification tools.

### To Order with Fabric or Leather Upholstered Back Jacket Specify:

1) Product number, including:

#### 1 Base/Caster Option:

##### Aluminum Base

- 1 Aluminum Base, Hard Caster, add **\$128.29** to list
- 2 Aluminum Base, Soft Caster, add **\$191.31** to list

##### Plastic Base

- 5 Plastic Std. Base, Hard Caster
- 6 Plastic Std. Base, Soft Caster, add **\$63.02** to list

- 2) Fabric surface and color (seat).
- 3) Mesh surface color (back).
- 4) Fabric surface and color (back jacket).
- 5) Trim color for frame. (Add **\$85.44** list for Snow.)
- 6) Trim color for base/arms. (Add **\$291.78** list for polished aluminum.)

### To Order with Knit or Mesh Back Specify:

1) Product number, including:

#### 1 Base/Caster Option:

##### Aluminum Base

- 1 Aluminum Base, Hard Caster, add **\$128.29** to list
- 2 Aluminum Base, Soft Caster, add **\$191.31** to list

##### Plastic Base

- 5 Plastic Std. Base, Hard Caster
- 6 Plastic Std. Base, Soft Caster, add **\$63.02** to list

- 2) Fabric surface and color (seat).
- 3) Knit or Mesh surface and color (back).
- 4) Trim color for frame. (Add **\$85.44** list for Snow.)
- 5) Trim color for base/arms. (Add **\$291.78** list for polished aluminum.)

# Zody

## Task Stool with 4D Arms

Upholstered Foam Seat	Adjustments	Number	Fabric Grade								Leather Grade A	Leather Grade B
			A	B	C	D	E	F	G	H		
<b>No Lumbar Adjustment - Mesh Back w/Plastic Base</b>												
Back Stop		SZTC-20-701MA	\$2275.87	\$2328.29	\$2384.18	\$2412.15	\$2433.10	\$2483.80	\$2529.18	\$2653.25	\$2738.84	\$2966.41
<b>No Lumbar Adjustment - Knit Back w/Plastic Base</b>												
Back Stop		SZTC-20-701MA	\$2484.05	\$2536.47	\$2592.36	\$2620.33	\$2641.28	\$2691.98	\$2737.36	\$2861.43	\$2947.02	\$3174.59
<b>No Lumbar Adjustment - Upholstered Back Jacket w/Plastic Base</b>												
Back Stop		SZTC-22-701MA	\$2448.83	\$2553.67	\$2665.45	\$2721.39	\$2763.29	\$2864.69	\$2955.45	\$3203.59	\$3374.77	\$3829.91
<b>Lumbar Adjustment - Mesh Back w/Plastic Base</b>												
Back Stop		SZTC-20-711MA	\$2429.63	\$2482.05	\$2537.94	\$2565.91	\$2586.86	\$2637.56	\$2682.94	\$2807.01	\$2892.60	\$3120.17
<b>Lumbar Adjustment - Knit Back w/Plastic Base</b>												
Back Stop		SZTC-20-711MA	\$2637.81	\$2690.23	\$2746.12	\$2774.09	\$2795.04	\$2845.74	\$2891.12	\$3015.19	\$3100.78	\$3328.35
<b>Lumbar Adjustment - Upholstered Back Jacket w/Plastic Base</b>												
Back Stop		SZTC-22-711MA	\$2602.59	\$2707.43	\$2819.21	\$2875.15	\$2917.05	\$3018.45	\$3109.21	\$3357.35	\$3528.53	\$3983.67
<b>PAL Back System - Mesh Back w/Plastic Base</b>												
Back Stop		SZTC-20-721MA	\$2469.81	\$2522.23	\$2578.12	\$2606.09	\$2627.04	\$2677.74	\$2723.12	\$2847.19	\$2932.78	\$3160.35
<b>PAL Back System - Knit Back w/Plastic Base</b>												
Back Stop		SZTC-20-721MA	\$2677.99	\$2730.41	\$2786.30	\$2814.27	\$2835.22	\$2885.92	\$2931.30	\$3055.37	\$3140.96	\$3368.53
<b>PAL Back System - Upholstered Back Jacket w/Plastic Base</b>												
Back Stop		SZTC-22-721MA	\$2642.77	\$2747.61	\$2859.39	\$2915.33	\$2957.23	\$3058.63	\$3149.39	\$3397.53	\$3568.71	\$4023.85

The following options require modification of the product number.

- Fixed seat
- Stain repellent
- Leather Seat with Mesh Back
- Leather Seat with Leather Upholstered Back Jacket
- Faux Leather Seat with Mesh Back
- Faux Leather Seat with Faux Leather Upholstered Back Jacket

- To specify, change the 11th digit from A to X; **Example:** SZTC-20-702MX1
- To specify, add **P** to end of the product number (add **\$54.18** list); **Example:** SZTC-20-712MA1P
- To specify, change the 5th digit to **1** and 6th digit to **0**; **Example:** SZTC-10-702MA5
- To specify, change the 5th digit to **1** and 6th digit to **1**; **Example:** SZTC-11-702MA5
- To specify, change the 5th digit to **3**; **Example:** SZTC-30-702MA5
- To specify, change the 5th and 6th digits to **33**; **Example:** SZTC-33-702MA5

**NOTE:** For available fabrics, refer to [surfaces.haworth.com](https://surfaces.haworth.com).

# Zody

## Task Stool with 4D Arms

Upholstered Gel Insert Seat	Adjustments	Number	①	Fabric Grade								Leather Grade A	Leather Grade B
				A	B	C	D	E	F	G	H		
<b>No Lumbar Adjustment - Mesh Back w/Plastic Base</b>													
	Back Stop	SZTC-20-701EA		\$2420.91	\$2473.33	\$2529.22	\$2557.19	\$2578.14	\$2628.84	\$2674.22	\$2798.29	\$2883.88	\$3111.45
<b>No Lumbar Adjustment - Knit Back w/Plastic Base</b>													
	Back Stop	SZTC-20-701EA		\$2629.09	\$2681.51	\$2737.40	\$2765.37	\$2786.32	\$2837.02	\$2882.40	\$3006.47	\$3092.06	\$3319.63
<b>No Lumbar Adjustment - Upholstered Back Jacket w/Plastic Base</b>													
	Back Stop	SZTC-22-701EA		\$2593.87	\$2698.71	\$2810.49	\$2866.43	\$2908.33	\$3009.73	\$3100.49	\$3348.63	\$3519.81	\$3974.95
<b>Lumbar Adjustment - Mesh Back w/Plastic Base</b>													
	Back Stop	SZTC-20-711EA		\$2574.67	\$2627.09	\$2682.98	\$2710.95	\$2731.90	\$2782.60	\$2827.98	\$2952.05	\$3037.64	\$3265.21
<b>Lumbar Adjustment - Knit Back w/Plastic Base</b>													
	Back Stop	SZTC-20-711EA		\$2782.85	\$2835.27	\$2891.16	\$2919.13	\$2940.08	\$2990.78	\$3036.16	\$3160.23	\$3245.82	\$3473.39
<b>Lumbar Adjustment - Upholstered Back Jacket w/Plastic Base</b>													
	Back Stop	SZTC-22-711EA		\$2747.63	\$2852.47	\$2964.25	\$3020.19	\$3062.09	\$3163.49	\$3254.25	\$3502.39	\$3673.57	\$4128.71
<b>PAL Back System - Mesh Back w/Plastic Base</b>													
	Back Stop	SZTC-20-721EA		\$2614.85	\$2667.27	\$2723.16	\$2751.13	\$2772.08	\$2822.78	\$2868.16	\$2992.23	\$3077.82	\$3305.39
<b>PAL Back System - Knit Back w/Plastic Base</b>													
	Back Stop	SZTC-20-721EA		\$2823.03	\$2875.45	\$2931.34	\$2959.31	\$2980.26	\$3030.96	\$3076.34	\$3200.41	\$3286.00	\$3513.57
<b>PAL Back System - Upholstered Back Jacket w/Plastic Base</b>													
	Back Stop	SZTC-22-721EA		\$2787.81	\$2892.65	\$3004.43	\$3060.37	\$3102.27	\$3203.67	\$3294.43	\$3542.57	\$3713.75	\$4168.89

The following options require modification of the product number.

- Fixed seat
- Stain repellent
- Leather Seat with Mesh Back
- Leather Seat with Leather Upholstered Back Jacket
- Faux Leather Seat with Mesh Back
- Faux Leather Seat with Faux Leather Upholstered Back Jacket

- To specify, change the 11th digit from A to X; **Example:** SZTC-20-702EX1
- To specify, add **P** to end of the product number (add **\$54.18** list); **Example:** SZTC-20-702EA1P
- To specify, change the 5th digit to **1** and 6th digit to **0**; **Example:** SZTC-10-702EA5
- To specify, change the 5th digit to **1** and 6th digit to **1**; **Example:** SZTC-11-702EA5
- To specify, change the 5th digit to **3**; **Example:** SZTC-30-702EA5
- To specify, change the 5th and 6th digits to **33**; **Example:** SZTC-33-702EA5

**NOTE:** For available fabrics, refer to [surfaces.haworth.com](https://surfaces.haworth.com).

This page intentionally blank

# Zody

## Task Stool with Height Adjustable Arms



SZTC-20-402MA1

### Dimensions\*

- \*SH: 21.5-29" (546mm-737mm)
- H: 43-51" (1092mm-1295mm)
- D: 29" (737mm)
- W: 29" (737mm)
- \*SW: 19.25" (489mm)
- \*SD: 16-19" (406mm-483mm)
- \*AH: 6.8-10.8" (173mm-274mm)

\* All measurements taken with the BIFMA chair measuring device.

### Features

- Back: Knit, mesh, or mesh back with upholstered back jacket.
- Seat: Standard upholstered with foam or optional foam with Technogel® Soft Lite gel insert.
- Seat Type: Standard adjustable [3" (76mm) range] or optional fixed.
- Base: Standard Plastic painted five-star base or optional painted aluminum or polished aluminum.
  - Plastic base available in Black.
  - Aluminum base available with painted Black, Metallic Silver, Metallic Champagne, or optional Polished Aluminum.
- Arms: Height-adjustable with soft arm caps. See matrix for default colors.
- Mechanism: Balanced 3-point tilt; standard tilt tension.
- Height adjustment: Pneumatic.
- Optional Back Stop: Tilt stop in 6 positions.
- Optional Asymmetrical Lumbar Adjustment: 4" (102mm) height adjustment; support level can be adjusted independently for right or left hand side of users body. Optional PAL Back System: Passive pelvic support.
- Casters: Hard or soft casters in black only.
- COM yardage / COL square footage:
  - Mesh back model: 0.75/10
  - Mesh back/upholstered back jacket: 1.5/18

**NOTE:** When specifying fabric or leather back jacket; must also specify mesh surface color for outside back.

Upcharge for mixed grade surfaces, refer to the electronic design and specification tools.

### To Order with Fabric or Leather Upholstered Back Jacket Specify:

1) Product number, including:

#### 1 Base/Caster Option:

##### Aluminum Base

- 1 Aluminum Base, Hard Caster, add **\$128.29** to list
- 2 Aluminum Base, Soft Caster, add **\$191.31** to list

##### Plastic Base

- 5 Plastic Std. Base, Hard Caster
- 6 Plastic Std. Base, Soft Caster, add **\$63.02** to list

- 2) Fabric surface and color (seat).
- 3) Mesh surface color (back).
- 4) Fabric surface and color (back jacket).
- 5) Trim color for frame. (Add **\$85.44** list for Snow.)
- 6) Trim color for base/arms. (Add **\$291.78** list for polished aluminum.)

### To Order with Knit or Mesh Back Specify:

1) Product number, including:

#### 1 Base/Caster Option:

##### Aluminum Base

- 1 Aluminum Base, Hard Caster, add **\$128.29** to list
- 2 Aluminum Base, Soft Caster, add **\$191.31** to list

##### Plastic Base

- 5 Plastic Std. Base, Hard Caster
- 6 Plastic Std. Base, Soft Caster, add **\$63.02** to list

- 2) Fabric surface and color (seat).
- 3) Knit or Mesh surface and color (back).
- 4) Trim color for frame. (Add **\$85.44** list for Snow.)
- 5) Trim color for base/arms. (Add **\$291.78** list for polished aluminum.)

Trim Color <sup>1</sup>	Arm Cap Color*	
	Black	Smoke
Black (TR-F)	•	
Smoke (TR-E)		•
Snow (TR-UFM)		•

\*Not specifiable.

<sup>1</sup>Plastic base option will default all metal trim to Black (TR-F).

# Zody

## Task Stool with Height Adjustable Arms

Upholstered Foam Seat	Adjustments	Number	①	Fabric Grade								Leather Grade A	Leather Grade B
				A	B	C	D	E	F	G	H		
<b>No Lumbar Adjustment - Mesh w/Plastic Base</b>													
Back Stop		SZTC-20-401MA		\$2218.21	\$2270.63	\$2326.52	\$2354.49	\$2375.44	\$2426.14	\$2471.52	\$2595.59	\$2681.18	\$2908.75
<b>No Lumbar Adjustment - Knit w/Plastic Base</b>													
Back Stop		SZTC-20-401MA		\$2426.39	\$2478.81	\$2534.70	\$2562.67	\$2583.62	\$2634.32	\$2679.70	\$2803.77	\$2889.36	\$3116.93
<b>No Lumbar Adjustment - Upholstered Back Jacket w/Plastic Base</b>													
Back Stop		SZTC-22-401MA		\$2391.17	\$2496.01	\$2607.79	\$2663.73	\$2705.63	\$2807.03	\$2897.79	\$3145.93	\$3317.11	\$3772.25
<b>Lumbar Adjustment - Mesh w/Plastic Base</b>													
Back Stop		SZTC-20-411MA		\$2371.97	\$2424.39	\$2480.28	\$2508.25	\$2529.20	\$2579.90	\$2625.28	\$2749.35	\$2834.94	\$3062.51
<b>Lumbar Adjustment - Knit w/Plastic Base</b>													
Back Stop		SZTC-20-411MA		\$2580.15	\$2632.57	\$2688.46	\$2716.43	\$2737.38	\$2788.08	\$2833.46	\$2957.53	\$3043.12	\$3270.69
<b>Lumbar Adjustment - Upholstered Back Jacket w/Plastic Base</b>													
Back Stop		SZTC-22-411MA		\$2544.93	\$2649.77	\$2761.55	\$2817.49	\$2859.39	\$2960.79	\$3051.55	\$3299.69	\$3470.87	\$3926.01
<b>PAL Back System - Mesh w/Plastic Base</b>													
Back Stop		SZTC-20-421MA		\$2412.15	\$2464.57	\$2520.46	\$2548.43	\$2569.38	\$2620.08	\$2665.46	\$2789.53	\$2875.12	\$3102.69
<b>PAL Back System - Knit w/Plastic Base</b>													
Back Stop		SZTC-20-421MA		\$2620.33	\$2672.75	\$2728.64	\$2756.61	\$2777.56	\$2828.26	\$2873.64	\$2997.71	\$3083.30	\$3310.87
<b>PAL Back System - Upholstered Back Jacket w/Plastic Base</b>													
Back Stop		SZTC-22-421MA		\$2585.11	\$2689.95	\$2801.73	\$2857.67	\$2899.57	\$3000.97	\$3091.73	\$3339.87	\$3511.05	\$3966.19

The following options require modification of the product number.

- Fixed seat
- Stain repellent
- Leather Seat with Mesh Back
- Leather Seat with Leather Upholstered Back Jacket
- Faux Leather Seat with Mesh Back
- Faux Leather Seat with Faux Leather Upholstered Back Jacket

- To specify, change the 11th digit from A to X; **Example:** SZTC-20-402MX1
- To specify, add **P** to end of the product number (add **\$54.18** list); **Example:** SZTC-20-401MAP
- To specify, change the 5th digit to **1** and 6th digit to **0**; **Example:** SZTC-10-402MA5
- To specify, change the 5th digit to **1** and 6th digit to **1**; **Example:** SZTC-11-402MA5
- To specify, change the 5th digit to **3**; **Example:** SZTC-30-402MA5
- To specify, change the 5th and 6th digits to **33**; **Example:** SZTC-33-402MA5

**NOTE:** For available fabrics, refer to [surfaces.haworth.com](https://surfaces.haworth.com).

# Zody

## Task Stool with Height Adjustable Arms

Upholstered Gel Insert Seat	Adjustments	Number	①	Fabric Grade								Leather Grade A	Leather Grade B
				A	B	C	D	E	F	G	H		
<b>No Lumbar Adjustment - Mesh w/Plastic Base</b>													
	Back Stop	SZTC-20-401EA		\$2363.25	\$2415.67	\$2471.56	\$2499.53	\$2520.48	\$2571.18	\$2616.56	\$2740.63	\$2826.22	\$3053.79
<b>No Lumbar Adjustment - Knit w/Plastic Base</b>													
	Back Stop	SZTC-20-401EA		\$2571.43	\$2623.85	\$2679.74	\$2707.71	\$2728.66	\$2779.36	\$2824.74	\$2948.81	\$3034.40	\$3261.97
<b>No Lumbar Adjustment - Upholstered Back Jacket w/Plastic Base</b>													
	Back Stop	SZTC-22-401EA		\$2536.21	\$2641.05	\$2752.83	\$2808.77	\$2850.67	\$2952.07	\$3042.83	\$3290.97	\$3462.15	\$3917.29
<b>Lumbar Adjustment - Mesh w/Plastic Base</b>													
	Back Stop	SZTC-20-411EA		\$2517.01	\$2569.43	\$2625.32	\$2653.29	\$2674.24	\$2724.94	\$2770.32	\$2894.39	\$2979.98	\$3207.55
<b>Lumbar Adjustment - Knit w/Plastic Base</b>													
	Back Stop	SZTC-20-411EA		\$2725.19	\$2777.61	\$2833.50	\$2861.47	\$2882.42	\$2933.12	\$2978.50	\$3102.57	\$3188.16	\$3415.73
<b>Lumbar Adjustment - Upholstered Back Jacket w/Plastic Base</b>													
	Back Stop	SZTC-22-411EA		\$2689.97	\$2794.81	\$2906.59	\$2962.53	\$3004.43	\$3105.83	\$3196.59	\$3444.73	\$3615.91	\$4071.05
<b>PAL Back System - Mesh w/Plastic Base</b>													
	Back Stop	SZTC-20-421EA		\$2557.19	\$2609.61	\$2665.50	\$2693.47	\$2714.42	\$2765.12	\$2810.50	\$2934.57	\$3020.16	\$3247.73
<b>PAL Back System - Knit w/Plastic Base</b>													
	Back Stop	SZTC-20-421EA		\$2765.37	\$2817.79	\$2873.68	\$2901.65	\$2922.60	\$2973.30	\$3018.68	\$3142.75	\$3228.34	\$3455.91
<b>PAL Back System - Upholstered Back Jacket w/Plastic Base</b>													
	Back Stop	SZTC-22-421EA		\$2730.15	\$2834.99	\$2946.77	\$3002.71	\$3044.61	\$3146.01	\$3236.77	\$3484.91	\$3656.09	\$4111.23

The following options require modification of the product number.

- Fixed seat
- Stain repellent
- Leather Seat with Mesh Back
- Leather Seat with Leather Upholstered Back Jacket
- Faux Leather Seat with Mesh Back
- Faux Leather Seat with Faux Leather Upholstered Back Jacket

- To specify, change the 11th digit from A to X; **Example:** SZTC-20-402EX1
  - To specify, add **P** to end of the product number (add **\$54.18** list); **Example:** SZTC-20-422EA1P
  - To specify, change the 5th digit to **1** and 6th digit to **0**; **Example:** SZTC-10-402EA5
  - To specify, change the 5th digit to **1** and 6th digit to **1**; **Example:** SZTC-11-402EA5
  - To specify, change the 5th digit to **3**; **Example:** SZTC-30-402EA5
  - To specify, change the 5th and 6th digits to **33**; **Example:** SZTC-33-402EA5
- NOTE:** For available fabrics, refer to [surfaces.haworth.com](https://surfaces.haworth.com).

This page intentionally blank



# Zody

## Task Stool with Fixed Arms



SZTC-20-102MA1

### Dimensions\*

- \*SH: 21.5-29" (546mm-737mm)
- H: 43-51"(1092mm-1295mm)
- D: 29"(737mm)
- W: 29"(737mm)
- \*SW: 19.25"(489mm)
- \*SD: 16-19"(406mm-483mm)
- \*AH: 9"(229mm)

\* All measurements taken with the BIFMA chair measuring device.

### Features

- Back: Knit, mesh, or mesh back with upholstered back jacket.
- Seat: Standard upholstered with foam or optional foam with Technogel® Soft Lite gel insert.
- Seat Type: Standard adjustable [3"(76mm) range] or optional fixed.
- Base: Standard Plastic painted five-star base or optional painted aluminum or polished aluminum. –Plastic base available in Black. –Aluminum base available with painted Black, Metallic Silver, Metallic Champagne, or optional Polished Aluminum.
- Arms: Fixed with soft arm caps. See matrix for default colors.
- Mechanism: Balanced 3-point tilt; standard tilt tension.
- Height adjustment: Pneumatic.
- Optional Back Stop: Tilt stop in 6 positions.
- Optional Asymmetrical Lumbar Adjustment: 4"(102mm) height adjustment; support level can be adjusted independently for right or left hand side of users body. Optional PAL Back System: Passive pelvic support.
- Casters: Hard or soft casters in black only.
- COM yardage / COL square footage:  
Mesh back model: 0.75/10  
Mesh back/upholstered back jacket: 1.5/18

**NOTE:** When specifying fabric or leather back jacket; must also specify mesh surface color for outside back.

Upcharge for mixed grade surfaces, refer to the electronic design and specification tools.

### To Order with Fabric or Leather Upholstered Back Jacket Specify:

1) Product number, including:

#### 1 Base/Caster Option:

##### Aluminum Base

- 1 Aluminum Base, Hard Caster, add **\$128.29** to list
- 2 Aluminum Base, Soft Caster, add **\$191.31** to list

##### Plastic Base

- 5 Plastic Std. Base, Hard Caster
- 6 Plastic Std. Base, Soft Caster, add **\$63.02** to list

- 2) Fabric surface and color (seat).
- 3) Mesh surface color (back).
- 4) Fabric surface and color (back jacket).
- 5) Trim color for frame. (Add **\$85.44** list for Snow.)
- 6) Trim color for base/arms. (Add **\$291.78** list for polished aluminum.)

### To Order with Knit or Mesh Back Specify:

1) Product number, including:

#### 1 Base/Caster Option:

##### Aluminum Base

- 1 Aluminum Base, Hard Caster, add **\$128.29** to list
- 2 Aluminum Base, Soft Caster, add **\$191.31** to list

##### Plastic Base

- 5 Plastic Std. Base, Hard Caster
- 6 Plastic Std. Base, Soft Caster, add **\$63.02** to list

- 2) Fabric surface and color (seat).
- 3) Knit or Mesh surface and color (back).
- 4) Trim color for frame. (Add **\$85.44** list for Snow.)
- 5) Trim color for base/arms. (Add **\$291.78** list for polished aluminum.)

Trim Color <sup>1</sup>	Arm Cap Color*	
	Black	Smoke
Black (TR-F)	•	
Smoke (TR-E)		•
Snow (TR-UFM)		•

\*Not specifiable.

<sup>1</sup>Plastic base option will default all metal trim to Black (TR-F).

# Zody

## Task Stool with Fixed Arms

Upholstered Foam Seat	Adjustments	Number	Fabric Grade								Leather Grade A	Leather Grade B
			A	B	C	D	E	F	G	H		
<b>No Lumbar Adjustment - Mesh Back w/Plastic Base</b>												
Back Stop		SZTC-20-101MA	\$2099.42	\$2151.84	\$2207.73	\$2235.70	\$2256.65	\$2307.35	\$2352.73	\$2476.80	\$2562.39	\$2789.96
<b>No Lumbar Adjustment - Knit Back w/Plastic Base</b>												
Back Stop		SZTC-20-101MA	\$2307.60	\$2360.02	\$2415.91	\$2443.88	\$2464.83	\$2515.53	\$2560.91	\$2684.98	\$2770.57	\$2998.14
<b>No Lumbar Adjustment - Upholstered Back Jacket w/Plastic Base</b>												
Back Stop		SZTC-22-101MA	\$2272.38	\$2377.22	\$2489.00	\$2544.94	\$2586.84	\$2688.24	\$2779.00	\$3027.14	\$3198.32	\$3653.46
<b>Lumbar Adjustment - Mesh Back w/Plastic Base</b>												
Back Stop		SZTC-20-111MA	\$2253.18	\$2305.60	\$2361.49	\$2389.46	\$2410.41	\$2461.11	\$2506.49	\$2630.56	\$2716.15	\$2943.72
<b>Lumbar Adjustment - Knit Back w/Plastic Base</b>												
Back Stop		SZTC-20-111MA	\$2461.36	\$2513.78	\$2569.67	\$2597.64	\$2618.59	\$2669.29	\$2714.67	\$2838.74	\$2924.33	\$3151.90
<b>Lumbar Adjustment - Upholstered Back Jacket w/Plastic Base</b>												
Back Stop		SZTC-22-111MA	\$2426.14	\$2530.98	\$2642.76	\$2698.70	\$2740.60	\$2842.00	\$2932.76	\$3180.90	\$3352.08	\$3807.22
<b>PAL Back System - Mesh Back w/Plastic Base</b>												
Back Stop		SZTC-20-121MA	\$2293.36	\$2345.78	\$2401.67	\$2429.64	\$2450.59	\$2501.29	\$2546.67	\$2670.74	\$2756.33	\$2983.90
<b>PAL Back System - Knit Back w/Plastic Base</b>												
Back Stop		SZTC-20-121MA	\$2501.54	\$2553.96	\$2609.85	\$2637.82	\$2658.77	\$2709.47	\$2754.85	\$2878.92	\$2964.51	\$3192.08
<b>PAL Back System - Upholstered Back Jacket w/Plastic Base</b>												
Back Stop		SZTC-22-121MA	\$2466.32	\$2571.16	\$2682.94	\$2738.88	\$2780.78	\$2882.18	\$2972.94	\$3221.08	\$3392.26	\$3847.40

The following options require modification of the product number.

- Fixed seat
- Stain repellent
- Leather Seat with Mesh Back
- Leather Seat with Leather Upholstered Back Jacket
- Faux Leather Seat with Mesh Back
- Faux Leather Seat with Faux Leather Upholstered Back Jacket

- To specify, change the 11th digit from A to X; **Example:** SZTC-20-102MX1
  - To specify, add **P** to end of the product number (add \$54.18 list); **Example:** SZTC-22-101MA1P
  - To specify, change the 5th digit to 1 and 6th digit to 0; **Example:** SZTC-10-102MA5
  - To specify, change the 5th digit to 1 and 6th digit to 1; **Example:** SZTC-11-102MA5
  - To specify, change the 5th digit to 3; **Example:** SZTC-30-102MA5
  - To specify, change the 5th and 6th digits to 33; **Example:** SZTC-33-102MA5
- NOTE:** For available fabrics, refer to [surfaces.haworth.com](https://surfaces.haworth.com).

# Zody

## Task Stool with Fixed Arms

Upholstered Gel Insert Seat	Adjustments	Number	①	Fabric Grade								Leather Grade A	Leather Grade B
				A	B	C	D	E	F	G	H		
<b>No Lumbar Adjustment - Mesh Back w/Plastic Base</b>													
	Back Stop	SZTC-20-101EA		\$2244.46	\$2296.88	\$2352.77	\$2380.74	\$2401.69	\$2452.39	\$2497.77	\$2621.84	\$2707.43	\$2935.00
<b>No Lumbar Adjustment - Knit Back w/Plastic Base</b>													
	Back Stop	SZTC-20-101EA		\$2452.64	\$2505.06	\$2560.95	\$2588.92	\$2609.87	\$2660.57	\$2705.95	\$2830.02	\$2915.61	\$3143.18
<b>No Lumbar Adjustment - Upholstered Back Jacket w/Plastic Base</b>													
	Back Stop	SZTC-22-101EA		\$2417.42	\$2522.26	\$2634.04	\$2689.98	\$2731.88	\$2833.28	\$2924.04	\$3172.18	\$3343.36	\$3798.50
<b>Lumbar Adjustment - Mesh Back w/Plastic Base</b>													
	Back Stop	SZTC-20-111EA		\$2398.22	\$2450.64	\$2506.53	\$2534.50	\$2555.45	\$2606.15	\$2651.53	\$2775.60	\$2861.19	\$3088.76
<b>Lumbar Adjustment - Knit Back w/Plastic Base</b>													
	Back Stop	SZTC-20-111EA		\$2606.40	\$2658.82	\$2714.71	\$2742.68	\$2763.63	\$2814.33	\$2859.71	\$2983.78	\$3069.37	\$3296.94
<b>Lumbar Adjustment - Upholstered Back Jacket w/Plastic Base</b>													
	Back Stop	SZTC-22-111EA		\$2571.18	\$2676.02	\$2787.80	\$2843.74	\$2885.64	\$2987.04	\$3077.80	\$3325.94	\$3497.12	\$3952.26
<b>PAL Back System - Mesh Back w/Plastic Base</b>													
	Back Stop	SZTC-20-121EA		\$2438.40	\$2490.82	\$2546.71	\$2574.68	\$2595.63	\$2646.33	\$2691.71	\$2815.78	\$2901.37	\$3128.94
<b>PAL Back System - Knit Back w/Plastic Base</b>													
	Back Stop	SZTC-20-121EA		\$2646.58	\$2699.00	\$2754.89	\$2782.86	\$2803.81	\$2854.51	\$2899.89	\$3023.96	\$3109.55	\$3337.12
<b>PAL Back System - Upholstered Back Jacket w/Plastic Base</b>													
	Back Stop	SZTC-22-121EA		\$2611.36	\$2716.20	\$2827.98	\$2883.92	\$2925.82	\$3027.22	\$3117.98	\$3366.12	\$3537.30	\$3992.44

The following options require modification of the product number.

- Fixed seat
- Stain repellent
- Leather Seat with Mesh Back
- Leather Seat with Leather Upholstered Back Jacket
- Faux Leather Seat with Mesh Back
- Faux Leather Seat with Faux Leather Upholstered Back Jacket

- To specify, change the 11th digit from A to X; **Example:** SZTC-20-102EX1
  - To specify, add **P** to end of the product number (add **\$54.18** list); **Example:** SZTC-20-102EA1P
  - To specify, change the 5th digit to **1** and 6th digit to **0**; **Example:** SZTC-10-102EA5
  - To specify, change the 5th digit to **1** and 6th digit to **1**; **Example:** SZTC-11-102EA5
  - To specify, change the 5th digit to **3**; **Example:** SZTC-30-102EA5
  - To specify, change the 5th and 6th digits to **33**; **Example:** SZTC-33-102EA5
- NOTE:** For available fabrics, refer to [surfaces.haworth.com](https://surfaces.haworth.com).

This page intentionally blank

**Zody**

## Task Stool without Arms



SZTC-20-002MA1

**Dimensions\***

- \*SH: 21.5-29"  
(546mm-737mm)
- H: 43-51"(1092mm-1295mm)
- D: 29"(737mm)
- W: 29"(737mm)
- \*SW: 19.25"(489mm)
- \*SD: 16-19"(406mm-483mm)

\* All measurements taken with the BIFMA chair measuring device.

**Features**

- Back: Knit, mesh, or mesh back with upholstered back jacket.
- Seat: Standard upholstered with foam or optional foam with Technogel® Soft Lite gel insert.
- Seat Type: Standard adjustable [3"(76mm) range] or optional fixed.
- Base: Standard Plastic painted five-star base or optional painted aluminum or polished aluminum.
  - Plastic base available in Black.
  - Aluminum base available with painted Black, Metallic Silver, Metallic Champagne, or optional Polished Aluminum.
- Mechanism: Balanced 3-point tilt; standard tilt tension.
- Height adjustment: Pneumatic.
- Optional Back Stop: Tilt stop in 6 positions.
- Optional Asymmetrical Lumbar Adjustment: 4"(102mm) height adjustment; support level can be adjusted independently for right or left hand side of users body. Optional PAL Back System: Passive pelvic support
- Casters: Hard or soft casters in black only.
- COM yardage / COL square footage:
  - Mesh back model: 0.75/10
  - Mesh back/upholstered back jacket: 1.5/18

**NOTE:** When specifying fabric or leather back jacket; must also specify mesh surface color for outside back.

**NOTE:** Plastic base option will default all metal trim to Black (TR-F).

Upcharge for mixed grade surfaces, refer to the electronic design and specification tools.

**To Order with Fabric or Leather Upholstered Back Jacket Specify:**

1) Product number, including:

**1 Base/Caster Option:****Aluminum Base**

- 1** Aluminum Base, Hard Caster, add **\$128.29** to list
- 2** Aluminum Base, Soft Caster, add **\$191.31** to list

**Plastic Base**

- 5** Plastic Std. Base, Hard Caster
- 6** Plastic Std. Base, Soft Caster, add **\$63.02** to list

- 2) Fabric surface and color (seat).
- 3) Mesh surface color (back).
- 4) Fabric surface and color (back jacket).
- 5) Trim color for frame. (Add **\$85.44** list for Snow.)
- 6) Trim color for base. (Add **\$291.78** list for polished aluminum.)

**To Order with Knit or Mesh Back Specify:**

1) Product number, including:

**1 Base/Caster Option:****Aluminum Base**

- 1** Aluminum Base, Hard Caster, add **\$128.29** to list
- 2** Aluminum Base, Soft Caster, add **\$191.31** to list

**Plastic Base**

- 5** Plastic Std. Base, Hard Caster
- 6** Plastic Std. Base, Soft Caster, add **\$63.02** to list

- 2) Fabric surface and color (seat).
- 3) Knit or Mesh surface and color (back).
- 4) Trim color for frame. (Add **\$85.44** list for Snow.)
- 5) Trim color for base. (Add **\$291.78** list for polished aluminum.)

# Zody

## Task Stool without Arms

Upholstered Foam Seat	Adjustments	Number	Fabric Grade								Leather Grade A	Leather Grade B
			A	B	C	D	E	F	G	H		
<b>No Lumbar Adjustment - Mesh Back w/Plastic Base</b>												
Back Stop		SZTC-20-001MA	\$1905.48	\$1957.90	\$2013.79	\$2041.76	\$2062.71	\$2113.41	\$2158.79	\$2282.86	\$2368.45	\$2596.02
<b>No Lumbar Adjustment - Knit Back w/Plastic Base</b>												
Back Stop		SZTC-20-001MA	\$2113.66	\$2166.08	\$2221.97	\$2249.94	\$2270.89	\$2321.59	\$2366.97	\$2491.04	\$2576.63	\$2804.20
<b>No Lumbar Adjustment - Upholstered Back Jacket w/Plastic Base</b>												
Back Stop		SZTC-22-001MA	\$2078.44	\$2183.28	\$2295.06	\$2351.00	\$2392.90	\$2494.30	\$2585.06	\$2833.20	\$3004.38	\$3459.52
<b>Lumbar Adjustment - Mesh Back w/Plastic Base</b>												
Back Stop		SZTC-20-011MA	\$2059.24	\$2111.66	\$2167.55	\$2195.52	\$2216.47	\$2267.17	\$2312.55	\$2436.62	\$2522.21	\$2749.78
<b>Lumbar Adjustment - Knit Back w/Plastic Base</b>												
Back Stop		SZTC-20-011MA	\$2267.42	\$2319.84	\$2375.73	\$2403.70	\$2424.65	\$2475.35	\$2520.73	\$2644.80	\$2730.39	\$2957.96
<b>Lumbar Adjustment - Upholstered Back Jacket w/Plastic Base</b>												
Back Stop		SZTC-22-011MA	\$2232.20	\$2337.04	\$2448.82	\$2504.76	\$2546.66	\$2648.06	\$2738.82	\$2986.96	\$3158.14	\$3613.28
<b>PAL Back System - Mesh Back w/Plastic Base</b>												
Back Stop		SZTC-20-021MA	\$2099.42	\$2151.84	\$2207.73	\$2235.70	\$2256.65	\$2307.35	\$2352.73	\$2476.80	\$2562.39	\$2789.96
<b>PAL Back System - Knit Back w/Plastic Base</b>												
Back Stop		SZTC-20-021MA	\$2307.60	\$2360.02	\$2415.91	\$2443.88	\$2464.83	\$2515.53	\$2560.91	\$2684.98	\$2770.57	\$2998.14
<b>PAL Back System - Upholstered Back Jacket w/Plastic Base</b>												
Back Stop		SZTC-22-021MA	\$2272.38	\$2377.22	\$2489.00	\$2544.94	\$2586.84	\$2688.24	\$2779.00	\$3027.14	\$3198.32	\$3653.46

The following options require modification of the product number.

- Fixed seat
- Stain repellent
- Leather Seat with Mesh Back
- Leather Seat with Leather Upholstered Back Jacket
- Faux Leather Seat with Mesh Back
- Faux Leather Seat with Faux Leather Upholstered Back Jacket

- To specify, change the 11th digit from A to X; **Example:** SZTC-20-002MX1
  - To specify, add **P** to end of the product number (add \$54.18 list); **Example:** SZTC-20-002MA1P
  - To specify, change the 5th digit to 1 and 6th digit to 0; **Example:** SZTC-10-002MA5
  - To specify, change the 5th digit to 1 and 6th digit to 1; **Example:** SZTC-11-002MA5
  - To specify, change the 5th digit to 3; **Example:** SZTC-30-002MA5
  - To specify, change the 5th and 6th digits to 33; **Example:** SZTC-33-002MA5
- NOTE:** For available fabrics, refer to [surfaces.haworth.com](https://surfaces.haworth.com).

# Zody

## Task Stool without Arms

Upholstered Gel Insert Seat	Adjustments	Number	①	Fabric Grade								Leather Grade A	Leather Grade B
				A	B	C	D	E	F	G	H		
<b>No Lumbar Adjustment - Mesh Back w/Plastic Base</b>													
	Back Stop	SZTC-20-001EA		\$2050.52	\$2102.94	\$2158.83	\$2186.80	\$2207.75	\$2258.45	\$2303.83	\$2427.90	\$2513.49	\$2741.06
<b>No Lumbar Adjustment - Knit Back w/Plastic Base</b>													
	Back Stop	SZTC-20-001EA		\$2258.70	\$2311.12	\$2367.01	\$2394.98	\$2415.93	\$2466.63	\$2512.01	\$2636.08	\$2721.67	\$2949.24
<b>No Lumbar Adjustment - Upholstered Back Jacket w/Plastic Base</b>													
	Back Stop	SZTC-22-001EA		\$2223.48	\$2328.32	\$2440.10	\$2496.04	\$2537.94	\$2639.34	\$2730.10	\$2978.24	\$3149.42	\$3604.56
<b>Lumbar Adjustment - Mesh Back w/Plastic Base</b>													
	Back Stop	SZTC-20-011EA		\$2204.28	\$2256.70	\$2312.59	\$2340.56	\$2361.51	\$2412.21	\$2457.59	\$2581.66	\$2667.25	\$2894.82
<b>Lumbar Adjustment - Knit Back w/Plastic Base</b>													
	Back Stop	SZTC-20-011EA		\$2412.46	\$2464.88	\$2520.77	\$2548.74	\$2569.69	\$2620.39	\$2665.77	\$2789.84	\$2875.43	\$3103.00
<b>Lumbar Adjustment - Upholstered Back Jacket w/Plastic Base</b>													
	Back Stop	SZTC-22-011EA		\$2377.24	\$2482.08	\$2593.86	\$2649.80	\$2691.70	\$2793.10	\$2883.86	\$3132.00	\$3303.18	\$3758.32
<b>PAL Back System - Mesh Back w/Plastic Base</b>													
	Back Stop	SZTC-20-021EA		\$2244.46	\$2296.88	\$2352.77	\$2380.74	\$2401.69	\$2452.39	\$2497.77	\$2621.84	\$2707.43	\$2935.00
<b>PAL Back System - Knit Back w/Plastic Base</b>													
	Back Stop	SZTC-20-021EA		\$2452.64	\$2505.06	\$2560.95	\$2588.92	\$2609.87	\$2660.57	\$2705.95	\$2830.02	\$2915.61	\$3143.18
<b>PAL Back System - Upholstered Back Jacket w/Plastic Base</b>													
	Back Stop	SZTC-22-021EA		\$2417.42	\$2522.26	\$2634.04	\$2689.98	\$2731.88	\$2833.28	\$2924.04	\$3172.18	\$3343.36	\$3798.50

The following options require modification of the product number.

- Fixed seat
- Stain repellent
- Leather Seat with Mesh Back
- Leather Seat with Leather Upholstered Back Jacket
- Faux Leather Seat with Mesh Back
- Faux Leather Seat with Faux Leather Upholstered Back Jacket

- To specify, change the 11th digit from A to X; **Example:** SZTC-20-002EX1
  - To specify, add **P** to end of the product number (add **\$54.18** list); **Example:** SZTC-20-002EA1P
  - To specify, change the 5th digit to **1** and 6th digit to **0**; **Example:** SZTC-10-002EA5
  - To specify, change the 5th digit to **1** and 6th digit to **1**; **Example:** SZTC-11-002EA5
  - To specify, change the 5th digit to **3**; **Example:** SZTC-30-002EA5
  - To specify, change the 5th and 6th digits to **33**; **Example:** SZTC-33-002EA5
- NOTE:** For available fabrics, refer to [surfaces.haworth.com](https://surfaces.haworth.com).

# Zody

## Sled Base



SZG-22-1

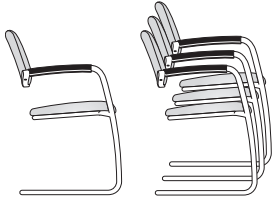

### Dimensions\*

- \*SH: 18" (457mm)
- H: 32.5" (826mm)
- D: 22.1" (501mm)
- W: 21" (533mm)
- \*SW: 16.8" (427mm)
- \*SD: 17" (432mm)
- \*AH: 26" (660mm)

\* All measurements taken with the BIFMA chair measuring device.

### Features

- Back: Upholstered or Wood (Beech)  
Fully cantilevered
- Seat: Upholstered
- Base: Sled
- Glide options: Plastic (S) or Felt (J)  
(Felt glides for use on hard floors. Glides are retrofittable. See e-Parts.)
- Felt glides are black color.
- Optional Trivalent chrome frame
- Stacking: 4-high
- COM Yardage / COL square footage  
Back: 0.75/15.2  
Seat: 0.75/15.2

### To Order, Specify:

1) Product number, including:

#### 1 Sled Base Glides:

- S** Plastic
- J** Felt

- 2) Seat surface and color
- 3) Back surface and color
- 4) Arm cap trim color
- 5) Base trim color  
Trivalent chrome (KR-V)  
add **\$291.78** list

Seat	Back	Number ①	Fabric Grade		C	D	E	F	G	H	Leather Grade A	Leather Grade B
			A	B								
Fabric	Fabric	SZG-22-1	\$1195.05	\$1292.91	\$1404.71	\$1460.59	\$1502.57	\$1600.37	\$1691.23	\$1942.85	N/A	N/A
Fabric	Wood	SZG-2W-1	1341.81	1390.74	1446.64	1474.58	1495.57	1544.47	1589.90	1715.71	N/A	N/A
Leather	Leather	SZG-11-1	N/A	N/A	N/A	N/A	N/A	N/A	N/A	N/A	\$2114.07	\$2566.13
Leather	Wood	SZG-1W-1	N/A	N/A	N/A	N/A	N/A	N/A	N/A	N/A	1801.32	2027.35

The following options require modification of the product number.

- Stain repellent
- Moisture barrier with Stain Repellent
- Faux Leather Seat and Back
- Faux Leather Seat with Wood Back

- To specify, add **P** to end of the product number (add **\$54.18** list)
- To specify, add **D** to end of the product number (add **\$73.38** list)
- To specify, change the 4th digit to **3** and 5th digit to **3**; **Example:** SZG-33-S
- To specify, change the 4th digit to **3** and 5th digit to **W**; **Example:** SZG-3W-J

**NOTE:** Upcharge for mixed grade surfaces, refer to the electronic design and specification tools.  
For available fabrics, refer to [surfaces.haworth.com](http://surfaces.haworth.com).



# Zody

4 Leg



SZG-22-1



### Dimensions\*

- \*SH: 18" (457mm)
- H: 32.5" (826mm)
- D: 22.13" (562mm)
- W: 21" (533mm)
- \*SW: 16.4" (417mm)
- \*SD: 17" (432mm)
- \*AH: 26" (660mm)

\* All measurements taken with the BIFMA chair measuring device.

### Features

- Back: Upholstered or Wood (Beech)  
Fully cantilevered
- Seat: Upholstered
- Base: 4 Legs
- Optional Glide: Plastic (H) or Felt (K)  
(Felt glides for use on hard floors. Glides are retrofittable. See e-Parts.)
- Felt glides are black color.
- Optional Trivalent chrome frame
- Stacking: 6-high
- COM Yardage / COL square footage  
Back: 0.75/15.2  
Seat: 0.75/15.2

### To Order, Specify:

1) Product number, including:

**1 Leg Base Glides:**

- H** Plastic
- K** Felt

- 2) Seat surface and color
- 3) Back surface and color
- 4) Arm cap trim color
- 5) Base trim color  
Trivalent chrome (KR-V)  
add **\$291.78** list

Seat	Back	Number ①	Fabric Grade								Leather Grade A	Leather Grade B
			A	B	C	D	E	F	G	H		
Fabric	Fabric	SZG-22-1	\$1001.11	\$1098.97	\$1210.77	\$1266.65	\$1308.63	\$1406.43	\$1497.29	\$1748.91	N/A	N/A
Fabric	Wood	SZG-2W-1	1147.87	1196.80	1252.70	1280.64	1301.63	1350.53	1395.96	1521.77	N/A	N/A
Leather	Leather	SZG-11-1	N/A	N/A	N/A	N/A	N/A	N/A	N/A	N/A	\$1920.13	\$2372.19
Leather	Wood	SZG-1W-1	N/A	N/A	N/A	N/A	N/A	N/A	N/A	N/A	1607.38	1833.41

The following options require modification of the product number.

- Stain repellent
- Moisture barrier with Stain Repellent
- Faux Leather Seat and Back
- Faux Leather Seat with Wood Back

To specify, add **P** to end of the product number (add **\$54.18** list)

To specify, add **D** to end of the product number (add **\$73.38** list)

To specify, change the 4th digit to **3** and 5th digit to **3**; **Example:** SZG-**33**-S

To specify, change the 4th digit to **3** and 5th digit to **W**; **Example:** SZG-**3W**-J

**NOTE:** Upcharge for mixed grade surfaces, refer to the electronic design and specification tools.

For available fabrics, refer to [surfaces.haworth.com](http://surfaces.haworth.com).

This page intentionally blank

# Very Task

## General Specifications

### At-A-Glance

The Very Task chair offers state-of-the-art ergonomic support. Very Task offers Haworth's patented asymmetrical lumbar along with supporting mesh or knit back. A clean simple aesthetic, with unlimited choices, allowing you to personalize how you want to sit and work.

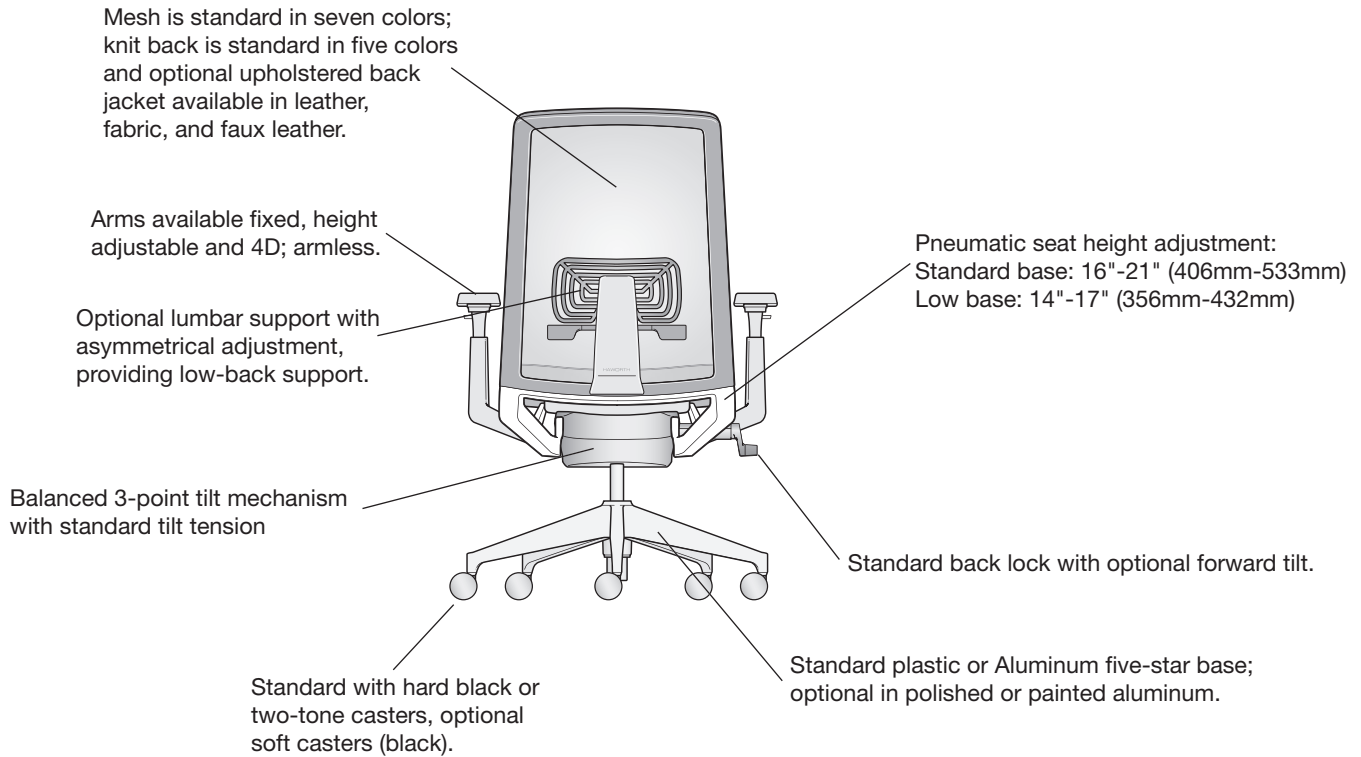

# Very Task

## General Specifications

### Features and Options (Task Chair)

- Back: Mesh or knit with optional upholstered back jacket.
- Seat: Standard upholstered with foam.
- Seat Type: Standard depth adjustable range 16"-19" (406mm-483mm).
- Base: Standard plastic or optional painted five-star aluminum base or optional polished aluminum.
- Optional low base 14"-17"(356mm-432mm) (not available in high polished)
- Arms: 4D, Height Adjustable arms, fixed arms with soft arm caps. Armless model available.
- Mechanism: Balanced 3-point tilt; standard tilt tension.
- Height adjustment: Pneumatic or low-position pneumatic.
- Standard Back lock.
- Optional Forward Tilt: 5 degrees downward from initial position.
- Optional Adjustable Lumbar: 4" adjustment, flexible support.
- Optional Headrest: Height adjustable with articulating movement.
- Casters: Five-star base with casters: hard (black or two-tone (fog and gray), soft (black).
- Headrest sent not attached.

### General Guidelines for Product Specification

	<u>S</u>	<u>C</u>	<u>T</u>	<u>- 2</u>	<u>0</u>	<u>- 4</u>	<u>1</u>	<u>1</u>	<u>1</u>	<u>3A-18</u>	<u>MS-FM</u>	<u>TR-F</u>	<u>TR-LE</u>	<u>TR-LE</u>
Product Fixed Arm	_____	_____	_____	_____	_____	_____	_____	_____	_____	_____	_____	_____	_____	_____
(S) Seating	_____	_____	_____	_____	_____	_____	_____	_____	_____	_____	_____	_____	_____	_____
Product Line	_____	_____	_____	_____	_____	_____	_____	_____	_____	_____	_____	_____	_____	_____
(C) Very	_____	_____	_____	_____	_____	_____	_____	_____	_____	_____	_____	_____	_____	_____
Model	_____	_____	_____	_____	_____	_____	_____	_____	_____	_____	_____	_____	_____	_____
(E) Headrest	_____	_____	_____	_____	_____	_____	_____	_____	_____	_____	_____	_____	_____	_____
(T) Task	_____	_____	_____	_____	_____	_____	_____	_____	_____	_____	_____	_____	_____	_____
Seat Upholstery	_____	_____	_____	_____	_____	_____	_____	_____	_____	_____	_____	_____	_____	_____
(1) Leather	_____	_____	_____	_____	_____	_____	_____	_____	_____	_____	_____	_____	_____	_____
(2) Fabric	_____	_____	_____	_____	_____	_____	_____	_____	_____	_____	_____	_____	_____	_____
(3) Faux Leather	_____	_____	_____	_____	_____	_____	_____	_____	_____	_____	_____	_____	_____	_____
Back	_____	_____	_____	_____	_____	_____	_____	_____	_____	_____	_____	_____	_____	_____
(0) Mesh or Knit - No Jacket	_____	_____	_____	_____	_____	_____	_____	_____	_____	_____	_____	_____	_____	_____
(1) Mesh with Leather Back Jacket	_____	_____	_____	_____	_____	_____	_____	_____	_____	_____	_____	_____	_____	_____
(2) Mesh with Fabric Back Jacket	_____	_____	_____	_____	_____	_____	_____	_____	_____	_____	_____	_____	_____	_____
(3) Mesh with Faux Leather Back Jacket	_____	_____	_____	_____	_____	_____	_____	_____	_____	_____	_____	_____	_____	_____
Arms	_____	_____	_____	_____	_____	_____	_____	_____	_____	_____	_____	_____	_____	_____
(0) No Arms	_____	_____	_____	_____	_____	_____	_____	_____	_____	_____	_____	_____	_____	_____
(1) Fixed Arms	_____	_____	_____	_____	_____	_____	_____	_____	_____	_____	_____	_____	_____	_____
(4) Height Adjustable	_____	_____	_____	_____	_____	_____	_____	_____	_____	_____	_____	_____	_____	_____
(7) 4D Arms	_____	_____	_____	_____	_____	_____	_____	_____	_____	_____	_____	_____	_____	_____
Lumbar	_____	_____	_____	_____	_____	_____	_____	_____	_____	_____	_____	_____	_____	_____
(0) No Lumbar	_____	_____	_____	_____	_____	_____	_____	_____	_____	_____	_____	_____	_____	_____
(1) Lumbar	_____	_____	_____	_____	_____	_____	_____	_____	_____	_____	_____	_____	_____	_____
Back Lock	_____	_____	_____	_____	_____	_____	_____	_____	_____	_____	_____	_____	_____	_____
(1) Back Lock	_____	_____	_____	_____	_____	_____	_____	_____	_____	_____	_____	_____	_____	_____
(4) Forward Tilt/Back Lock	_____	_____	_____	_____	_____	_____	_____	_____	_____	_____	_____	_____	_____	_____
Base/Caster	_____	_____	_____	_____	_____	_____	_____	_____	_____	_____	_____	_____	_____	_____
(1) Aluminum Standard Base, Hard Caster	_____	_____	_____	_____	_____	_____	_____	_____	_____	_____	_____	_____	_____	_____
(2) Aluminum Standard Base, Soft Caster	_____	_____	_____	_____	_____	_____	_____	_____	_____	_____	_____	_____	_____	_____
(3) Aluminum Low Base, Hard Caster	_____	_____	_____	_____	_____	_____	_____	_____	_____	_____	_____	_____	_____	_____
(4) Aluminum Low Base, Soft Caster	_____	_____	_____	_____	_____	_____	_____	_____	_____	_____	_____	_____	_____	_____
(5) Plastic Standard Base, Hard Caster	_____	_____	_____	_____	_____	_____	_____	_____	_____	_____	_____	_____	_____	_____
(6) Plastic Standard Base, Soft Caster	_____	_____	_____	_____	_____	_____	_____	_____	_____	_____	_____	_____	_____	_____
(P) Plastic Standard Base, Two-Tone Caster	_____	_____	_____	_____	_____	_____	_____	_____	_____	_____	_____	_____	_____	_____
(T) Aluminum Standard Base, Two-Tone Caster	_____	_____	_____	_____	_____	_____	_____	_____	_____	_____	_____	_____	_____	_____
Seat Upholstery	_____	_____	_____	_____	_____	_____	_____	_____	_____	_____	_____	_____	_____	_____
Tellure	_____	_____	_____	_____	_____	_____	_____	_____	_____	_____	_____	_____	_____	_____
Back Upholstery	_____	_____	_____	_____	_____	_____	_____	_____	_____	_____	_____	_____	_____	_____
Mesh Snow	_____	_____	_____	_____	_____	_____	_____	_____	_____	_____	_____	_____	_____	_____
Trim Color (Plastic Components)	_____	_____	_____	_____	_____	_____	_____	_____	_____	_____	_____	_____	_____	_____
Black	_____	_____	_____	_____	_____	_____	_____	_____	_____	_____	_____	_____	_____	_____
Frame Trim Color (Aluminum)	_____	_____	_____	_____	_____	_____	_____	_____	_____	_____	_____	_____	_____	_____
Metallic Silver	_____	_____	_____	_____	_____	_____	_____	_____	_____	_____	_____	_____	_____	_____
Base Trim Color (Plastic or Aluminum)	_____	_____	_____	_____	_____	_____	_____	_____	_____	_____	_____	_____	_____	_____
Metallic Silver	_____	_____	_____	_____	_____	_____	_____	_____	_____	_____	_____	_____	_____	_____

# Very Task

## General Specifications

<b>Environmental Factors</b>	<ul style="list-style-type: none"> <li>• Refer to Product Environmental Data sheet (PED) for recycled content and certifications.</li> <li>• Very is produced in an ISO 14001 certified manufacturing facility.</li> <li>• Very Task is part of the Haworth Take Back Program.</li> <li>• Haworth will take back Very chairs after their useful life and recycle the components. Please contact Haworth's Material Recovery Center at (616)393-1215.</li> </ul>
<b>COM &amp; COL General Information</b>	<p>To order a COM fabric (Customer's Own Material), contact the Haworth Inquiry Center (1.800.426.8562), your local Haworth dealer, or go to <a href="http://haworth.com/surfaces">haworth.com/surfaces</a> to find out if the COM you have selected has already been tested and approved. The surface collection site also has information on the Haworth alliance program with Carnegie, Luna Textiles, and Maharam as well as our industry-leading Pre-Approved COM program.</p> <p>COM fabrics are placed into Grades based on the cost per linear yard. If a fabric's cost exceeds the range of our highest Grade it will be noted as Non-Graded. The product will be priced at Grade A; the COM fabric costs will appear as a separate line item. The fabric charge will be Haworth's purchase cost plus a 4% administrative fee (based on the cost of the fabric). Yardage calculations will include any applicable fabric repeat.</p> <p>COM Leather products will be priced at a leather Grade A; COL costs will appear as a separate line item. The leather costs will be Haworth's purchase cost plus a 4% administrative fee (based on the cost of the leather).</p>
<b>Finishes and Fabrics</b>	A complete listing of finishes and fabrics for Very seating is available in the back of the price list.
<b>Stain Repellent</b>	<p>Stain Repellent or Stain Repellent with Moisture Barrier available on fabric surfaces only.</p> <p>Stain Repellent only: To specify add "<b>P</b>" to the end of the product number. Example: SCT-20-0011<b>P</b></p> <p>Stain Repellent with Moisture Barrier: To specify add "<b>D</b>" to the end of the product number. Example: SCT-20-0011<b>D</b></p>
<b>Shipping Weights (Including packaging)</b>	<ul style="list-style-type: none"> <li>• Chairs with arms: 55.2 pounds/1 chair per carton/17.37 cubic feet</li> <li>• Chairs without arms: 51.2 pounds/1 chair per carton/17.37 cubic feet</li> </ul>
<b>Seat</b>	Stitched double seams. Vertically in the center and on the edges of the leather seat cushion.
<b>Back</b>	Vertical stitched double seams on the upholstered back jacket with leather and faux leather or Customers Own Leather or COM faux leather.

# Very Task

## General Specifications

### STANDARD MOBILITY AND ADJUSTABILITY

#### Balanced 3-point tilt



#### Features:

- Balanced 3-point tilt mechanism.
- Back reclines 20° from the upright position.
- Seat pan moves downward 3° from the initial position.
- 2:1 recline ratio.

#### Benefits:

- Comfortable relaxed posture.
- Recline allows for the opening of the users' chest cavity providing good airflow to promote alertness.
- Users' feet remain flat on the floor.

#### Tilt Tension Control

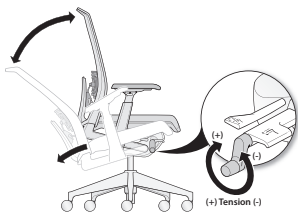

#### Feature:

- Easy-to-reach and easy-to-activate side-mounted unlimited tilt tension control regulates the amount of resistance felt when leaning back in the chair and the effort required to recline the chair backwards.

#### Benefit:

- Personalized support to accommodate users of different body types and different work styles.

#### Seat Height Adjustment

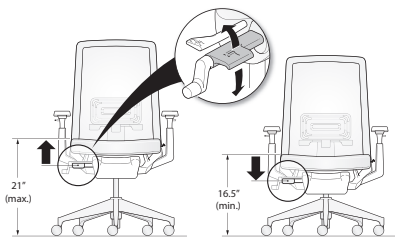

#### Features:

- Pneumatic seat height adjustment.
- Seat height adjusts 5"(127mm) from 16" to 21"(406mm to 533mm) in standard models. Low-position adjusts 14" to 17"(356 to 432mm).

#### Benefits:

- Ensures the comfort of the lower limbs by avoiding pressure on the underside of the thigh caused by a seat pan that is too high, or decreased thigh-to-torso angle if the seat pan is too low.
- Seat height adjustment also is important in setting the proper hand position and allowing for a proper sitting eye height.

#### Seat Depth Adjustment

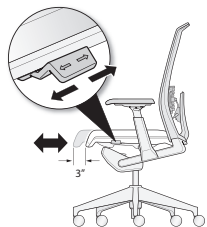

#### Features:

- 3"(76mm) of seat depth range.

#### Benefit:

- Supports the thighs, allows users to rest against the seat back for back support, and avoids pressure on the back of the knees of small to tall users.

**Very Task**

General Specifications

OPTIONAL MOBILITY AND ADJUSTABILITY

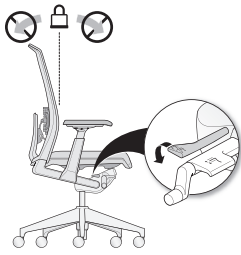
**Back Lock****Feature:**

- Single position Back Lock.

**Benefit:**

- Allows users to lock the back of the chair in the upright position for tasking application.

**Forward Tilt****Features:**

- Optional forward tilt.
- 5°

**Benefit:**

- Allows users the ability to elect an upright forward position.

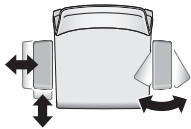
**4D Arm****Features:**

- Optional 4D arm.
- Arm adjusts in 4 ways:
  - Height adjustment: 4"(102mm)
  - Side-to-side arm cap adjustment range: 3"(76mm) [1.5"(38.1mm) each arm cap]
  - Front-to-back adjustment range: 3.5"(89mm)
  - Pivoting: In 20°; out 20°

**Benefits:**

- Arms support the muscular system of users' neck and shoulders and proper arm support provides back relief. Arms can be an aid in standing or sitting down.
- Height adjustment accommodates for users with varying elbow rest heights so that users avoid lifting their shoulders or leaning sideways to get arm support.
- Front-to-back adjustment adjusts the armrest length, which is important because it allows users to get close to the worksurface while maintaining the effective use of the backrest.
- Side-to-side adjustment ensures a comfortable resting position for the arms with proper support of the forearm while allowing for easy entry/exit of the chair.
- Pivoting provides proper support of the forearm when performing tasks involving keying and mousing.

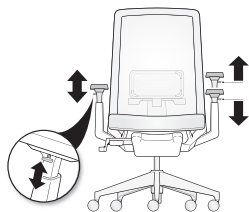
**Adjustable Height Arm****Feature:**

- Optional height adjustable arms adjust 4"(102mm) vertically.

**Benefit:**

- Height adjustment accommodates users with varying elbow rest heights so that users avoid lifting their shoulders or leaning sideways to get arm support.

# Very Task

## General Specifications

### OPTIONAL MOBILITY AND ADJUSTABILITY

---

#### Lumbar Support

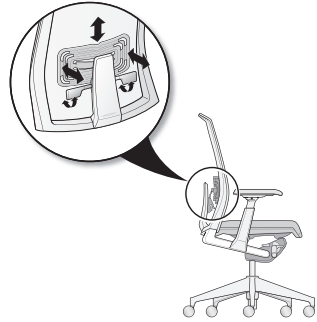

#### Features:

- Asymmetrical Left/right Lumbar Adjustment adjusts 4"(102mm) in height, flexible lumbar support with depth adjustment.

#### Benefits:

- Lumbar adjustment maintains the natural curvature of the spine at the lower back and allows users to choose the support that feels right for them.

---

#### Headrest



#### Features:

- Height adjustable 4.2"(107mm), articulating movement of headrest pad and mount to fit a wide range of users.
- Headrest is TPU material. Available in two finishes: black or fog; coordinates with the chair armrest color specified.
- See price pages for specification (available on all models).
- To add a headrest to an existing model in the field order service part: Back and Headrest placement, see e-Parts.
- Headrest sent not attached.



This page intentionally blank

# Very Task

## Task Chair with 4D Arms

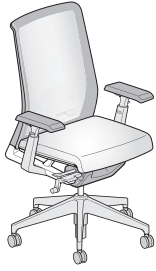

SCT-20-7011

**Dimensions**

\*SH: 16-21"(406mm-533mm)  
 H: 39-44"(991mm-1118mm)  
 D: 26"(660mm)  
 W: 27"(686mm)  
 \*SW: 19"(483mm)  
 SD: 16"-19"  
 (406mm-483mm)  
 AH: 6.5"-10.5"  
 (165mm-267mm)

Low Base:  
 14-17"(356mm-432mm)

\* Measurements taken with the BIFMA chair measuring device.

**Features**

- Back: Knit, mesh or mesh back with upholstered back jacket.
- Seat: Standard upholstered foam (3 lbs. polyurethane foam construction).
- Base: Plastic base or optional painted five-star aluminum or polished aluminum base.
- Arms: 4D with soft arm caps. Arm adjusts up and down, side to side, front to back and pivot in and out.
- Mechanism: Balanced 3-point tilt; standard tilt tension.
- Back Lock: Single position upright back lock.
- Optional Forward Tilt: 5 degrees downward from initial position.
- Optional Asymmetrical Lumbar Adjustment: 4"(102mm) height adjustment; support level can be adjusted independently for right or left hand side of users body.
- Casters: Standard with hard black or two-tone casters; optional soft casters.
- COM yardage / COL square footage:  
 Mesh back model: 0.83/20  
 Mesh back/upholstered back jacket: 1.5/40

**NOTE:** When specifying a back jacket; must also specify mesh surface color for outside of back. Back jacket is not field retrofittable. To add a back jacket in the field, see e-Parts for replacement back with an attached jacket.

**To Order, Specify:**

1) Product number, including:

**1 Base/Caster Option:****Aluminum Base**

- 1** Aluminum Std. Base, Hard Caster
- 2** Aluminum Std. Base, Soft Caster, add **\$59.01** to list
- T** Aluminum Std. Base, Two-Tone Casters
- 3** Aluminum Low Base, Hard Caster
- 4** Aluminum Low Base, Soft Caster, add **\$59.01** to list

**Plastic Base**

- 5** Plastic Std. Base, Hard Caster
- 6** Plastic Std. Base, Soft Caster, add **\$59.01** to list
- P** Plastic Std. Base, Two-Tone Casters

- 2) Fabric surface and color (seat).
- 3) Knit or mesh surface and color (back).
- 4) Back Jacket (if applicable) Fabric surface and color.
- 5) Trim color (plastic components) (arm caps, control cover, adjustment levers, 4D or height adjustable arm uprights).

**Note:** If TR-UFM is specified, arm caps and adjustment levers default to TR-7 Fog. (Add **\$136.74** list for TR-UFM Snow.)

- 6) Frame trim color (aluminum components - underside of chair).
- 7) Base trim color (plastic or aluminum) dependent upon base style selected; TR-UFM Snow (plastic) and TR-FS Snowfall (aluminum) not available.

**Note:** If PM-P Polished Aluminum is selected for aluminum frame components (#6) or aluminum base (#7), or both, a total upcharge of **\$280.13** list will apply.

## Very Task

Task Chair with 4D Arms

Upholstered Seat Adjustments	Number ①	Fabric Grade								Leather Grade A	Leather Grade B
		A	B	C	D	E	F	G	H		
<b>Plastic Base - Mesh Back</b>											
Back Lock	SCT-20-701	\$1377.11	\$1427.70	\$1481.94	\$1507.24	\$1528.93	\$1575.92	\$1619.28	\$1734.95	\$1837.96	\$2063.52
Forward Tilt/Back Lock	SCT-20-704	1476.52	1527.11	1581.35	1606.65	1628.34	1675.33	1718.69	1834.36	1937.37	2162.93
<b>Plastic Base - Knit Back</b>											
Back Lock	SCT-20-701	\$1533.22	\$1583.81	\$1638.05	\$1663.35	\$1685.04	\$1732.03	\$1775.39	\$1891.06	\$1994.07	\$2219.63
Forward Tilt/Back Lock	SCT-20-704	1632.63	1683.22	1737.46	1762.76	1784.45	1831.44	1874.80	1990.47	2093.48	2319.04
<b>Plastic Base - Upholstered Back Jacket</b>											
Back Lock	SCT-22-701	\$1566.87	\$1668.05	\$1776.53	\$1827.13	\$1870.51	\$1964.49	\$2051.21	\$2282.55	\$2488.57	\$2939.69
Forward Tilt/Back Lock	SCT-22-704	1666.28	1767.46	1875.94	1926.54	1969.92	2063.90	2150.62	2381.96	2587.98	3039.10
<b>Plastic Base with Lumbar Adjustment - Mesh Back</b>											
Back Lock	SCT-20-711	\$1503.62	\$1554.21	\$1608.45	\$1633.75	\$1655.44	\$1702.43	\$1745.79	\$1861.46	\$1964.47	\$2190.03
Forward Tilt/Back Lock	SCT-20-714	1603.03	1653.62	1707.86	1733.16	1754.85	1801.84	1845.20	1960.87	2063.88	2289.44
<b>Plastic Base with Lumbar Adjustment - Knit Back</b>											
Back Lock	SCT-20-711	\$1659.73	\$1710.32	\$1764.56	\$1789.86	\$1811.55	\$1858.54	\$1901.90	\$2017.57	\$2120.58	\$2346.14
Forward Tilt/Back Lock	SCT-20-714	1759.14	1809.73	1863.97	1889.27	1910.96	1957.95	2001.31	2116.98	2219.99	2445.55
<b>Plastic Base with Lumbar Adjustment - Upholstered Back Jacket</b>											
Back Lock	SCT-22-711	\$1693.38	\$1794.56	\$1903.04	\$1953.64	\$1997.02	\$2091.00	\$2177.72	\$2409.06	\$2615.08	\$3066.20
Forward Tilt/Back Lock	SCT-22-714	1792.79	1893.97	2002.45	2053.05	2096.43	2190.41	2277.13	2508.47	2714.49	3165.61
<b>Aluminum Base - Mesh Back</b>											
Back Lock	SCT-20-701	\$1467.49	\$1518.08	\$1572.32	\$1597.62	\$1619.31	\$1666.30	\$1709.66	\$1825.33	\$1928.34	\$2153.90
Forward Tilt/Back Lock	SCT-20-704	1566.90	1617.49	1671.73	1697.03	1718.72	1765.71	1809.07	1924.74	2027.75	2253.31
<b>Aluminum Base - Knit Back</b>											
Back Lock	SCT-20-701	\$1623.60	\$1674.19	\$1728.43	\$1753.73	\$1775.42	\$1822.41	\$1865.77	\$1981.44	\$2084.45	\$2310.01
Forward Tilt/Back Lock	SCT-20-704	1723.01	1773.60	1827.84	1853.14	1874.83	1921.82	1965.18	2080.85	2183.86	2409.42
<b>Aluminum Base - Upholstered Back Jacket</b>											
Back Lock	SCT-22-701	\$1657.25	\$1758.43	\$1866.91	\$1917.51	\$1960.89	\$2054.87	\$2141.59	\$2372.93	\$2578.95	\$3030.07
Forward Tilt/Back Lock	SCT-22-704	1756.66	1857.84	1966.32	2016.92	2060.30	2154.28	2241.00	2472.34	2678.36	3129.48
<b>Aluminum Base with Lumbar Adjustment - Mesh Back</b>											
Back Lock	SCT-20-711	\$1594.00	\$1644.59	\$1698.83	\$1724.13	\$1745.82	\$1792.81	\$1836.17	\$1951.84	\$2054.85	\$2280.41
Forward Tilt/Back Lock	SCT-20-714	1693.41	1744.00	1798.24	1823.54	1845.23	1892.22	1935.58	2051.25	2154.26	2379.82
<b>Aluminum Base with Lumbar Adjustment - Knit Back</b>											
Back Lock	SCT-20-711	\$1750.11	\$1800.70	\$1854.94	\$1880.24	\$1901.93	\$1948.92	\$1992.28	\$2107.95	\$2210.96	\$2436.52
Forward Tilt/Back Lock	SCT-20-714	1849.52	1900.11	1954.35	1979.65	2001.34	2048.33	2091.69	2207.36	2310.37	2535.93
<b>Aluminum Base with Lumbar Adjustment - Upholstered Back Jacket</b>											
Back Lock	SCT-22-711	\$1783.76	\$1884.94	\$1993.42	\$2044.02	\$2087.40	\$2181.38	\$2268.10	\$2499.44	\$2705.46	\$3156.58
Forward Tilt/Back Lock	SCT-22-714	1883.17	1984.35	2092.83	2143.43	2186.81	2280.79	2367.51	2598.85	2804.87	3255.99

The following options require modification of the product number.

Headrest

Leather Seat with Knit or Mesh Back

Leather Seat with Leather Upholstered Back Jacket

Faux Leather Seat with Knit or Mesh Back

Stain repellent

To specify, change the 3rd digit from a T to an E. Example: SCE-22-7112 with headrest (add \$126.51 list)

To specify, change the 4th digit to 1; **Example:** SCT-10-7011

To specify, change the 4th digit to 1 and 5th digit to 1; **Example:** SCT-11-7011

To specify, change the 4th digit to 3; **Example:** SCT-30-7011

To specify, add P to end of the product number; **Example:** SCT-20-7011P (add \$56.03 list)

**NOTE:** Stain repellent is available on SCT-20 and SCT-22 models only.

# Very Task

## Task Chair with Height Adjustable Arms

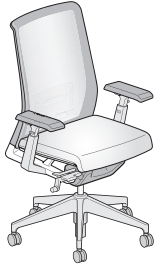

SCT-20-4011

**Dimensions**

\*SH: 16-21"(406mm-533mm)  
 H: 39-44"(991mm-1118mm)  
 D: 26"(660mm)  
 W: 27"(686mm)  
 \*SW: 19"(483mm)  
 SD: 16"-19"(406mm-483mm)  
 AH: 6.5"-10.5"  
 (165mm-267mm)

Low Base:  
 14-17"(356mm-432mm)

\* Measurements taken with the BIFMA chair measuring device.

**Features**

- Back: Knit, mesh only or mesh back with upholstered back jacket.
- Seat: Standard upholstered foam (3 lbs. polyurethane foam construction).
- Base: Plastic base or optional painted five-star aluminum or polished aluminum base.
- Arms: Height-adjustable arms with plastic uprights (black or fog) with soft arm caps.
- Mechanism: Balanced 3-point tilt; standard tilt tension.
- Back Lock: Single position upright back lock.
- Optional Forward Tilt: 5 degrees downward from initial position.
- Optional Asymmetrical Lumbar Adjustment: 4"(102mm) height adjustment; support level can be adjusted independently for right or left hand side of users body.
- Casters: Standard with hard black or two-tone casters; optional soft casters.
- COM yardage / COL square footage:  
 Mesh back model: 0.83/20  
 Mesh back/upholstered back jacket: 1.5/40

**NOTE:** When specifying a back jacket; must also specify mesh surface color for outside of back. Back jacket is not field retrofittable. To add a back jacket in the field, see e-Parts for replacement back with an attached jacket.

**To Order, Specify:**

1) Product number, including:

**1 Base/Caster Option:****Aluminum Base**

- 1** Aluminum Std. Base, Hard Caster
- 2** Aluminum Std. Base, Soft Caster, add **\$59.01** to list
- T** Aluminum Std. Base, Two-Tone Casters
- 3** Aluminum Low Base, Hard Caster
- 4** Aluminum Low Base, Soft Caster, add **\$59.01** to list

**Plastic Base**

- 5** Plastic Std. Base, Hard Caster
- 6** Plastic Std. Base, Soft Caster, add **\$59.01** to list
- P** Plastic Std. Base, Two-Tone Casters

- 2) Fabric surface and color (seat).
- 3) Knit or mesh surface and color (back).
- 4) Back Jacket (if applicable) Fabric surface and color.
- 5) Trim color (plastic components) (arm caps, control cover, adjustment levers, 4D or height adjustable arm uprights).

**Note:** If TR-UFM is specified, arm caps and adjustment levers default to TR-7 Fog. (Add **\$136.74** list for TR-UFM Snow.)

- 6) Frame trim color (aluminum components - underside of chair).
- 7) Base trim color (plastic or aluminum) dependent upon base style selected; TR-UFM Snow (plastic) and TR-FS Snowfall (aluminum) not available.

**Note:** If PM-P Polished Aluminum is selected for aluminum frame components (#6) or aluminum base (#7), or both, a total upcharge of **\$280.13** list will apply.

**Very Task**

Task Chair with Height Adjustable Arms

Upholstered Foam Seat Adjustments	Number ①	Fabric Grade								Leather Grade A	Leather Grade B
		A	B	C	D	E	F	G	H		
<b>Plastic Base - Mesh Back</b>											
Back Lock	SCT-20-401	\$1286.74	\$1337.33	\$1391.57	\$1416.87	\$1438.56	\$1485.55	\$1528.91	\$1644.58	\$1747.59	\$1973.15
Forward Tilt/Back Lock	SCT-20-404	1386.15	1436.74	1490.98	1516.28	1537.97	1584.96	1628.32	1743.99	1847.00	2072.56
<b>Plastic Base - Knit Back</b>											
Back Lock	SCT-20-401	\$1442.85	\$1493.44	\$1547.68	\$1572.98	\$1594.67	\$1641.66	\$1685.02	\$1800.69	\$1903.70	\$2129.26
Forward Tilt/Back Lock	SCT-20-404	1542.26	1592.85	1647.09	1672.39	1694.08	1741.07	1784.43	1900.10	2003.11	2228.67
<b>Plastic Base - Upholstered Back Jacket</b>											
Back Lock	SCT-22-401	\$1476.50	\$1577.68	\$1686.16	\$1736.76	\$1780.14	\$1874.12	\$1960.84	\$2192.18	\$2398.20	\$2849.32
Forward Tilt/Back Lock	SCT-22-404	1575.91	1677.09	1785.57	1836.17	1879.55	1973.53	2060.25	2291.59	2497.61	2948.73
<b>Plastic Base with Lumbar Adjustment - Mesh Back</b>											
Back Lock	SCT-20-411	\$1413.25	\$1463.84	\$1518.08	\$1543.38	\$1565.07	\$1612.06	\$1655.42	\$1771.09	\$1874.10	\$2099.66
Forward Tilt/Back Lock	SCT-20-414	1512.66	1563.25	1617.49	1642.79	1664.48	1711.47	1754.83	1870.50	1973.51	2199.07
<b>Plastic Base with Lumbar Adjustment - Knit Back</b>											
Back Lock	SCT-20-411	\$1569.36	\$1619.95	\$1674.19	\$1699.49	\$1721.18	\$1768.17	\$1811.53	\$1927.20	\$2030.21	\$2255.77
Forward Tilt/Back Lock	SCT-20-414	1668.77	1719.36	1773.60	1798.90	1820.59	1867.58	1910.94	2026.61	2129.62	2355.18
<b>Plastic Base with Lumbar Adjustment - Upholstered Back Jacket</b>											
Back Lock	SCT-22-411	\$1603.01	\$1704.19	\$1812.67	\$1863.27	\$1906.65	\$2000.63	\$2087.35	\$2318.69	\$2524.71	\$2975.83
Forward Tilt/Back Lock	SCT-22-414	1702.42	1803.60	1912.08	1962.68	2006.06	2100.04	2186.76	2418.10	2624.12	3075.24
<b>Aluminum Base - Mesh Back</b>											
Back Lock	SCT-20-401	\$1377.12	\$1427.71	\$1481.95	\$1507.25	\$1528.94	\$1575.93	\$1619.29	\$1734.96	\$1837.97	\$2063.53
Forward Tilt/Back Lock	SCT-20-404	1476.53	1527.12	1581.36	1606.66	1628.35	1675.34	1718.70	1834.37	1937.38	2162.94
<b>Aluminum Base - Knit Back</b>											
Back Lock	SCT-20-401	\$1533.23	\$1583.82	\$1638.06	\$1663.36	\$1685.05	\$1732.04	\$1775.40	\$1891.07	\$1994.08	\$2219.64
Forward Tilt/Back Lock	SCT-20-404	1632.64	1683.23	1737.47	1762.77	1784.46	1831.45	1874.81	1990.48	2093.49	2319.05
<b>Aluminum Base - Upholstered Back Jacket</b>											
Back Lock	SCT-22-401	\$1566.88	\$1668.06	\$1776.54	\$1827.14	\$1870.52	\$1964.50	\$2051.22	\$2282.56	\$2488.58	\$2939.70
Forward Tilt/Back Lock	SCT-22-404	1666.29	1767.47	1875.95	1926.55	1969.93	2063.91	2150.63	2381.97	2587.99	3039.11
<b>Aluminum Base with Lumbar Support - Mesh Back</b>											
Back Lock	SCT-20-411	\$1503.63	\$1554.22	\$1608.46	\$1633.76	\$1655.45	\$1702.44	\$1745.80	\$1861.47	\$1964.48	\$2190.04
Forward Tilt/Back Lock	SCT-20-414	1603.04	1653.63	1707.87	1733.17	1754.86	1801.85	1845.21	1960.88	2063.89	2289.45
<b>Aluminum Base with Lumbar Adjustment - Knit Back</b>											
Back Lock	SCT-20-411	\$1659.74	\$1710.33	\$1764.57	\$1789.87	\$1811.56	\$1858.55	\$1901.91	\$2017.58	\$2120.59	\$2346.15
Forward Tilt/Back Lock	SCT-20-414	1759.15	1809.74	1863.98	1889.28	1910.97	1957.96	2001.32	2116.99	2220.00	2445.56
<b>Aluminum Base with Lumbar Adjustment - Upholstered Back Jacket</b>											
Back Lock	SCT-22-411	\$1693.39	\$1794.57	\$1903.05	\$1953.65	\$1997.03	\$2091.01	\$2177.73	\$2409.07	\$2615.09	\$3066.21
Forward Tilt/Back Lock	SCT-22-414	1792.80	1893.98	2002.46	2053.06	2096.44	2190.42	2277.14	2508.48	2714.50	3165.62

The following options require modification of the product number.

Headrest

Leather Seat with Knit or Mesh Back

Leather Seat with Leather Upholstered Back Jacket

Faux Leather Seat with Knit or Mesh Back

Stain repellent

To specify, change the 3rd digit from a T to an E. Example: SCT-22-7112 with headrest (add \$126.51 list)

To specify, change the 4th digit to 1; **Example:** SCT-10-4011

To specify, change the 4th digit to 1 and 5th digit to 1; **Example:** SCT-11-4011

To specify, change the 4th digit to 3; **Example:** SCT-30-4011

To specify, add P to end of the product number; **Example:** SCT-20-4011P (add \$56.03 list)

**NOTE:** Stain repellent is available on SCT-20 and SCT-22 models only.

# Very Task

## Task Chair with Fixed Arms



SCT-20-1011

### Dimensions

\*SH: 16-21"(406mm-533mm)  
 H: 39-44"(991mm-1118mm)  
 D: 26"(660mm)  
 W: 27"(686mm)  
 \*SW: 19"(483mm)  
 SD: 16"-19"  
 (406mm-483mm)  
 AH: 8"(203mm)

Low Base:  
 14-17"(356mm-432mm)

\* Measurements taken with the BIFMA chair measuring device.

### Features

- Back: Knit, mesh only or mesh back with upholstered back jacket.
- Seat: Standard upholstered foam (3 lbs. polyurethane foam construction).
- Seat Type: Standard adjustable 3"(76mm) range.
- Base: Plastic base or optional painted five-star aluminum or polished aluminum base.
- Arms: Fixed height arms with aluminum uprights in either painted or polished, soft arm caps.
- Mechanism: Balanced 3-point tilt; standard tilt tension.
- Back Lock: Single position upright back lock.
- Optional Forward Tilt: 5 degrees downward from initial position.
- Optional Asymmetrical Lumbar Adjustment: 4"(102mm) height adjustment; support level can be adjusted independently for right or left hand side of users body.
- Casters: Standard with hard black or two-tone casters; optional soft casters.
- COM yardage / COL square footage:  
 Mesh back model: 0.83/20  
 Mesh back/upholstered back jacket: 1.5/40

**NOTE:** When specifying a back jacket; must also specify mesh surface color for outside of back. Back jacket is not field retrofittable. To add a back jacket in the field, see e-Parts for replacement back with an attached jacket.

### To Order, Specify:

1) Product number, including:

#### 1 Base/Caster Option:

##### Aluminum Base

- 1** Aluminum Std. Base, Hard Caster
- 2** Aluminum Std. Base, Soft Caster, add **\$59.01** to list
- T** Aluminum Std. Base, Two-Tone Casters
- 3** Aluminum Low Base, Hard Caster
- 4** Aluminum Low Base, Soft Caster, add **\$59.01** to list

##### Plastic Base

- 5** Plastic Std. Base, Hard Caster
- 6** Plastic Std. Base, Soft Caster, add **\$59.01** to list
- P** Plastic Std. Base, Two-Tone Casters

- 2) Fabric surface and color (seat).
- 3) Knit or mesh surface and color (back).
- 4) Back Jacket (if applicable) Fabric surface and color.
- 5) Trim color (plastic components) (arm caps, control cover, adjustment levers, 4D or height adjustable arm uprights).

**Note:** If TR-UFM is specified, arm caps and adjustment levers default to TR-7 Fog. (Add **\$136.74** list for TR-UFM Snow.)

- 6) Frame trim color (aluminum components - underside of chair).
- 7) Base trim color (plastic or aluminum) dependent upon base style selected; TR-UFM Snow (plastic) and TR-FS Snowfall (aluminum) not available.

**Note:** If PM-P Polished Aluminum is selected for aluminum frame components (#6) or aluminum base (#7), or both, a total upcharge of **\$280.13** list will apply.

## Very Task

Task Chair with Fixed Arms

Upholstered Foam Seat Adjustments	Number ①	Fabric Grade								Leather Grade A	Leather Grade B
		A	B	C	D	E	F	G	H		
<b>Plastic Base - Mesh Back</b>											
Back Lock	SCT-20-101	\$1268.66	\$1319.25	\$1373.49	\$1398.79	\$1420.48	\$1467.47	\$1510.83	\$1626.50	\$1729.51	\$1955.07
Forward Tilt/Back Lock	SCT-20-104	1368.07	1418.66	1472.90	1498.20	1519.89	1566.88	1610.24	1725.91	1828.92	2054.48
<b>Plastic Base - Knit Back</b>											
Back Lock	SCT-20-101	\$1424.77	\$1475.36	\$1529.60	\$1554.90	\$1576.59	\$1623.58	\$1666.94	\$1782.61	\$1885.62	\$2111.18
Forward Tilt/Back Lock	SCT-20-104	1524.18	1574.77	1629.01	1654.31	1676.00	1722.99	1766.35	1882.02	1985.03	2210.59
<b>Plastic Base - Upholstered Back Jacket</b>											
Back Lock	SCT-22-101	\$1458.42	\$1559.60	\$1668.08	\$1718.68	\$1762.06	\$1856.04	\$1942.76	\$2174.10	\$2380.12	\$2831.24
Forward Tilt/Back Lock	SCT-22-104	1557.83	1659.01	1767.49	1818.09	1861.47	1955.45	2042.17	2273.51	2479.53	2930.65
<b>Plastic Base with Lumbar Adjustment - Mesh Back</b>											
Back Lock	SCT-20-111	\$1395.17	\$1445.76	\$1500.00	\$1525.30	\$1546.99	\$1593.98	\$1637.34	\$1753.01	\$1856.02	\$2081.58
Forward Tilt/Back Lock	SCT-20-114	1494.58	1545.17	1599.41	1624.71	1646.40	1693.39	1736.75	1852.42	1955.43	2180.99
<b>Plastic Base with Lumbar Adjustment - Knit Back</b>											
Back Lock	SCT-20-111	\$1551.28	\$1601.87	\$1656.11	\$1681.41	\$1703.10	\$1750.09	\$1793.45	\$1909.12	\$2012.13	\$2237.69
Forward Tilt/Back Lock	SCT-20-114	1650.69	1701.28	1755.52	1780.82	1802.51	1849.50	1892.86	2008.53	2111.54	2337.10
<b>Plastic Base with Lumbar Adjustment - Upholstered Back Jacket</b>											
Back Lock	SCT-22-111	\$1584.93	\$1686.11	\$1794.59	\$1845.19	\$1888.57	\$1982.55	\$2069.27	\$2300.61	\$2506.63	\$2957.75
Forward Tilt/Back Lock	SCT-22-114	1684.34	1785.52	1894.00	1944.60	1987.98	2081.96	2168.68	2400.02	2606.04	3057.16
<b>Aluminum Base - Mesh Back</b>											
Back Lock	SCT-20-101	\$1359.04	\$1409.63	\$1463.87	\$1489.17	\$1510.86	\$1557.85	\$1601.21	\$1716.88	\$1819.89	\$2045.45
Forward Tilt/Back Lock	SCT-20-104	1458.45	1509.04	1563.28	1588.58	1610.27	1657.26	1700.62	1816.29	1919.30	2144.86
<b>Aluminum Base - Knit Back</b>											
Back Lock	SCT-20-101	\$1515.15	\$1565.74	\$1619.98	\$1645.28	\$1666.97	\$1713.96	\$1757.32	\$1872.99	\$1976.00	\$2201.56
Forward Tilt/Back Lock	SCT-20-104	1614.56	1665.15	1719.39	1744.69	1766.38	1813.37	1856.73	1972.40	2075.41	2300.97
<b>Aluminum Base - Upholstered Back Jacket</b>											
Back Lock	SCT-22-101	\$1548.80	\$1649.98	\$1758.46	\$1809.06	\$1852.44	\$1946.42	\$2033.14	\$2264.48	\$2470.50	\$2921.62
Forward Tilt/Back Lock	SCT-22-104	1648.21	1749.39	1857.87	1908.47	1951.85	2045.83	2132.55	2363.89	2569.91	3021.03
<b>Aluminum Base with Lumbar Adjustment - Mesh Back</b>											
Back Lock	SCT-20-111	\$1485.55	\$1536.14	\$1590.38	\$1615.68	\$1637.37	\$1684.36	\$1727.72	\$1843.39	\$1946.40	\$2171.96
Forward Tilt/Back Lock	SCT-20-114	1584.96	1635.55	1689.79	1715.09	1736.78	1783.77	1827.13	1942.80	2045.81	2271.37
<b>Aluminum Base with Lumbar Adjustment - Knit Back</b>											
Back Lock	SCT-20-111	\$1641.66	\$1692.25	\$1746.49	\$1771.79	\$1793.48	\$1840.47	\$1883.83	\$1999.50	\$2102.51	\$2328.07
Forward Tilt/Back Lock	SCT-20-114	1741.07	1791.66	1845.90	1871.20	1892.89	1939.88	1983.24	2098.91	2201.92	2427.48
<b>Aluminum Base with Lumbar Adjustment - Upholstered Back Jacket</b>											
Back Lock	SCT-22-111	\$1675.31	\$1776.49	\$1884.97	\$1935.57	\$1978.95	\$2072.93	\$2159.65	\$2390.99	\$2597.01	\$3048.13
Forward Tilt/Back Lock	SCT-22-114	1774.72	1875.90	1984.38	2034.98	2078.36	2172.34	2259.06	2490.40	2696.42	3147.54

The following options require modification of the product number.

Headrest

Leather Seat with Knit or Mesh Back

Leather Seat with Leather Upholstered Back Jacket

Faux Leather Seat with Knit or Mesh Back

Stain repellent

To specify, change the 3rd digit from a T to an E. Example: SCE-22-7112 with headrest (add \$126.51 list)

To specify, change the 4th digit to 1; **Example:** SCT-10-1011

To specify, change the 4th digit to 1 and 5th digit to 1; **Example:** SCT-11-1011

To specify, change the 4th digit to 3; **Example:** SCT-30-1011

To specify, add P to end of the product number; **Example:** SCT-20-1011P (add \$56.03 list)

**NOTE:** Stain repellent is available on SCT-20 and SCT-22 models only.

# Very Task

## Task Chair without Arms

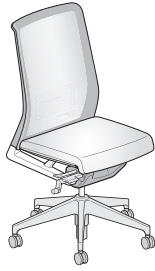

SCT-20-0011

### Dimensions

\*SH: 16-21"(406mm-533mm)  
 H: 39-44"(991mm-1118mm)  
 D: 26"(660mm)  
 W: 27"(686mm)  
 \*SW: 19"(483mm)  
 SD: 16"-19"  
 (406mm-483mm)

Low Base:  
 14-17"(356mm-432mm)

\* Measurements taken with the BIFMA chair measuring device.

### Features

- Back: Knit, mesh only or mesh back with upholstered back jacket.
- Seat: Standard upholstered foam (3 lbs. polyurethane foam construction).
- Seat Type: Standard adjustable 3"(76mm) range.
- Base: Plastic base or optional painted five-star aluminum or polished aluminum base.
- Mechanism: Balanced 3-point tilt; standard tilt tension.
- Back Lock: Single position upright back lock.
- Optional Forward Tilt: 5 degrees downward from initial position.
- Optional Asymmetrical Lumbar Adjustment: 4"(102mm) height adjustment; support level can be adjusted independently for right or left hand side of users body.
- Casters: Standard with hard black or two-tone casters; optional soft casters.
- COM yardage / COL square footage:  
 Mesh back model: 0.83/20  
 Mesh back/upholstered back jacket: 1.5/40

**NOTE:** When specifying a back jacket; must also specify mesh surface color for outside of back. Back jacket is not field retrofittable. To add a back jacket in the field, see e-Parts for replacement back with an attached jacket.

### To Order, Specify:

1) Product number, including:

#### 1 Base/Caster Option:

##### Aluminum Base

- 1** Aluminum Std. Base, Hard Caster
- 2** Aluminum Std. Base, Soft Caster, add **\$59.01** to list
- T** Aluminum Std. Base, Two-Tone Casters
- 3** Aluminum Low Base, Hard Caster
- 4** Aluminum Low Base, Soft Caster, add **\$59.01** to list

##### Plastic Base

- 5** Plastic Std. Base, Hard Caster
- 6** Plastic Std. Base, Soft Caster, add **\$59.01** to list
- P** Plastic Std. Base, Two-Tone Casters

- 2) Fabric surface and color (seat).
- 3) Knit or mesh surface and color (back).
- 4) Back Jacket (if applicable) Fabric surface and color.
- 5) Trim color (plastic components) (arm caps, control cover, adjustment levers, 4D or height adjustable arm uprights).

**Note:** If TR-UFM is specified, arm caps and adjustment levers default to TR-7 Fog. (Add **\$136.74** list for TR-UFM Snow.)

- 6) Frame trim color (aluminum components - underside of chair).
- 7) Base trim color (plastic or aluminum) dependent upon base style selected; TR-UFM Snow (plastic) and TR-FS Snowfall (aluminum) not available.

**Note:** If PM-P Polished Aluminum is selected for aluminum frame components (#6) or aluminum base (#7), or both, a total upcharge of **\$280.13** list will apply.



**Very Task**

Task Chair without Arms

Upholstered Foam Seat Adjustments	Number ①	Fabric Grade								Leather Grade A	Leather Grade B
		A	B	C	D	E	F	G	H		
<b>Plastic Base - Mesh Back</b>											
Back Lock	SCT-20-001	\$1060.84	\$1111.43	\$1165.67	\$1190.97	\$1212.66	\$1259.65	\$1303.01	\$1418.68	\$1521.69	\$1747.25
Forward Tilt/Back Lock	SCT-20-004	1160.25	1210.84	1265.08	1290.38	1312.07	1359.06	1402.42	1518.09	1621.10	1846.66
<b>Plastic Base - Knit Back</b>											
Back Lock	SCT-20-001	\$1216.95	\$1267.54	\$1321.78	\$1347.08	\$1368.77	\$1415.76	\$1459.12	\$1574.79	\$1677.80	\$1903.36
Forward Tilt/Back Lock	SCT-20-004	1316.36	1366.95	1421.19	1446.49	1468.18	1515.17	1558.53	1674.20	1777.21	2002.77
<b>Plastic Base - Upholstered Back Jacket</b>											
Back Lock	SCT-22-001	\$1250.60	\$1351.78	\$1460.26	\$1510.86	\$1554.24	\$1648.22	\$1734.94	\$1966.28	\$2172.30	\$2623.42
Forward Tilt/Back Lock	SCT-22-004	1350.01	1451.19	1559.67	1610.27	1653.65	1747.63	1834.35	2065.69	2271.71	2722.83
<b>Plastic Base with Lumbar Adjustment - Mesh Back</b>											
Back Lock	SCT-20-011	\$1187.35	\$1237.94	\$1292.18	\$1317.48	\$1339.17	\$1386.16	\$1429.52	\$1545.19	\$1648.20	\$1873.76
Forward Tilt/Back Lock	SCT-20-014	1286.76	1337.35	1391.59	1416.89	1438.58	1485.57	1528.93	1644.60	1747.61	1973.17
<b>Plastic Base with Lumbar Adjustment - Knit Back</b>											
Back Lock	SCT-20-011	\$1343.46	\$1394.05	\$1448.29	\$1473.59	\$1495.28	\$1542.27	\$1585.63	\$1701.30	\$1804.31	\$2029.87
Forward Tilt/Back Lock	SCT-20-014	1442.87	1493.46	1547.70	1573.00	1594.69	1641.68	1685.04	1800.71	1903.72	2129.28
<b>Plastic Base with Lumbar Adjustment - Upholstered Back Jacket</b>											
Back Lock	SCT-22-011	\$1377.11	\$1478.29	\$1586.77	\$1637.37	\$1680.75	\$1774.73	\$1861.45	\$2092.79	\$2298.81	\$2749.93
Forward Tilt/Back Lock	SCT-22-014	1476.52	1577.70	1686.18	1736.78	1780.16	1874.14	1960.86	2192.20	2398.22	2849.34
<b>Aluminum Base - Mesh Back</b>											
Back Lock	SCT-20-001	\$1151.22	\$1201.81	\$1256.05	\$1281.35	\$1303.04	\$1350.03	\$1393.39	\$1509.06	\$1612.07	\$1837.63
Forward Tilt/Back Lock	SCT-20-004	1250.63	1301.22	1355.46	1380.76	1402.45	1449.44	1492.80	1608.47	1711.48	1937.04
<b>Aluminum Base - Knit Back</b>											
Back Lock	SCT-20-001	\$1307.33	\$1357.92	\$1412.16	\$1437.46	\$1459.15	\$1506.14	\$1549.50	\$1665.17	\$1768.18	\$1993.74
Forward Tilt/Back Lock	SCT-20-004	1406.74	1457.33	1511.57	1536.87	1558.56	1605.55	1648.91	1764.58	1867.59	2093.15
<b>Aluminum Base - Upholstered Back Jacket</b>											
Back Lock	SCT-22-001	\$1340.98	\$1442.16	\$1550.64	\$1601.24	\$1644.62	\$1738.60	\$1825.32	\$2056.66	\$2262.68	\$2713.80
Forward Tilt/Back Lock	SCT-22-004	1440.39	1541.57	1650.05	1700.65	1744.03	1838.01	1924.73	2156.07	2362.09	2813.21
<b>Aluminum Base with Lumbar Adjustment - Mesh Back</b>											
Back Lock	SCT-20-011	\$1277.73	\$1328.32	\$1382.56	\$1407.86	\$1429.55	\$1476.54	\$1519.90	\$1635.57	\$1738.58	\$1964.14
Forward Tilt/Back Lock	SCT-20-014	1377.14	1427.73	1481.97	1507.27	1528.96	1575.95	1619.31	1734.98	1837.99	2063.55
<b>Aluminum Base with Lumbar Adjustment - Knit Back</b>											
Back Lock	SCT-20-011	\$1433.84	\$1484.43	\$1538.67	\$1563.97	\$1585.66	\$1632.65	\$1676.01	\$1791.68	\$1894.69	\$2120.25
Forward Tilt/Back Lock	SCT-20-014	1533.25	1583.84	1638.08	1663.38	1685.07	1732.06	1775.42	1891.09	1994.10	2219.66
<b>Aluminum Base with Lumbar Adjustment - Upholstered Back Jacket</b>											
Back Lock	SCT-22-011	\$1467.49	\$1568.67	\$1677.15	\$1727.75	\$1771.13	\$1865.11	\$1951.83	\$2183.17	\$2389.19	\$2840.31
Forward Tilt/Back Lock	SCT-22-014	1566.90	1668.08	1776.56	1827.16	1870.54	1964.52	2051.24	2282.58	2488.60	2939.72

The following options require modification of the product number.

Headrest

Leather Seat with Knit or Mesh Back

Leather Seat with Leather Upholstered Back Jacket

Faux Leather Seat with Knit or Mesh Back

Stain repellent

To specify, change the 3rd digit from a T to an E. Example: SCE-22-7112 with headrest (add \$126.51 list)

To specify, change the 4th digit to 1; **Example:** SCT-10-0011

To specify, change the 4th digit to 1 and 5th digit to 1; **Example:** SCT-11-0011

To specify, change the 4th digit to 3; **Example:** SCT-30-0011

To specify, add P to end of the product number; **Example:** SCT-20-0011P (add \$56.03 list)

**NOTE:** Stain repellent is available on SCT-20 and SCT-22 models only.

# Very Task

## Task Stool with 4D Arms



SCTC-20-7011

### Dimensions

- \*SH: 20-28"  
(508mm-711mm)
- H: 43-51"  
(1092mm-1295mm)
- D: 26"(660mm)
- W: 27"(686mm)
- \*SW: 19"(483mm)
- SD: 16"-19"  
(406mm-483mm)
- AH: 6.5"-10.5"  
(165mm-267mm)

\* Measurements taken with the BIFMA chair measuring device.

### Features

- Back: Knit, mesh or mesh back with upholstered back jacket.
- Seat: Standard upholstered foam (3 lbs. polyurethane foam construction).
- Base: Plastic base or optional painted five-star aluminum or polished aluminum base.
- Arms: 4D with soft arm caps. Arm adjusts up and down, side to side, front to back and pivot in and out.
- Mechanism: Balanced 3-point tilt; standard tilt tension.
- Back Lock: Single position upright back lock.
- Optional Asymmetrical Lumbar Adjustment: 4"(102mm) height adjustment; support level can be adjusted independently for right or left hand side of users body.
- Casters: Standard with hard black or two-tone casters; optional soft casters.
- Adjustable height foot ring.
- COM yardage / COL square footage:  
Mesh back model: 0.83/20  
Mesh back/upholstered back jacket: 1.5/40

**NOTE:** When specifying a back jacket; must also specify mesh surface color for outside of back. Back jacket is not field retrofittable. To add a back jacket in the field, see e-Parts for replacement back with an attached jacket.

### To Order, Specify:

1) Product number, including:

#### 1 Base/Caster Option:

##### Aluminum Base

- 1** Aluminum Std. Base, Hard Caster
- 2** Aluminum Std. Base, Soft Caster, add **\$59.01** to list
- T** Aluminum Std. Base, Two-Tone Casters

##### Plastic Base

- 5** Plastic Std. Base, Hard Caster
- 6** Plastic Std. Base, Soft Caster, add **\$59.01** to list
- P** Plastic Std. Base, Two-Tone Casters

- 2) Fabric surface and color (seat).
- 3) Knit or mesh surface and color (back).
- 4) Back Jacket (if applicable) Fabric surface and color.
- 5) Trim color (plastic components) (arm caps, control cover, adjustment levers, 4D or height adjustable arm uprights).

**Note:** If TR-UFM is specified, arm caps and adjustment levers default to TR-7 Fog. (Add **\$136.74** list for TR-UFM Snow.)

- 6) Frame trim color (aluminum components - underside of chair).
- 7) Base trim color (plastic or aluminum) dependent upon base style selected; TR-UFM Snow (plastic) and TR-FS Snowfall (aluminum) not available.

**Note:** If PM-P Polished Aluminum is selected for aluminum frame components (#6) or aluminum base (#7), or both, a total upcharge of **\$280.13** list will apply.

**Very Task**

Task Stool with 4D Arms

Upholstered Seat Adjustments	Number ①	Fabric Grade								Leather Grade A	Leather Grade B
		A	B	C	D	E	F	G	H		
<b>Plastic Base</b>											
Mesh Back/Back Lock	SCTC-20-701	\$2002.32	\$2052.91	\$2107.15	\$2132.45	\$2154.14	\$2201.13	\$2244.49	\$2360.16	\$2463.17	\$2688.73
Knit Back/Back Lock	SCTC-20-701	2158.43	2209.02	2263.26	2288.56	2310.25	2357.24	2400.60	2516.27	2619.28	2844.84
Upholstered Back Jacket/Back Lock	SCTC-22-701	2192.08	2293.26	2401.74	2452.34	2495.72	2589.70	2676.42	2907.76	3113.78	3564.90
<b>Plastic Base with Lumbar Adjustment</b>											
Mesh Back/Back Lock	SCTC-20-711	\$2128.83	\$2179.42	\$2233.66	\$2258.96	\$2280.65	\$2327.64	\$2371.00	\$2486.67	\$2589.68	\$2815.24
Knit Back/Back Lock	SCTC-20-711	2284.94	2335.53	2389.77	2415.07	2436.76	2483.75	2527.11	2642.78	2745.79	2971.35
Upholstered Back Jacket/Back Lock	SCTC-22-711	2318.59	2419.77	2528.25	2578.85	2622.23	2716.21	2802.93	3034.27	3240.29	3691.41
<b>Aluminum Base</b>											
Mesh Back/Back Lock	SCTC-20-701	\$2092.70	\$2143.29	\$2197.53	\$2222.83	\$2244.52	\$2291.51	\$2334.87	\$2450.54	\$2553.55	\$2779.11
Knit Back/Back Lock	SCTC-20-701	2248.81	2299.40	2353.64	2378.94	2400.63	2447.62	2490.98	2606.65	2709.66	2935.22
Upholstered Back Jacket/Back Lock	SCTC-22-701	2282.46	2383.64	2492.12	2542.72	2586.10	2680.08	2766.80	2998.14	3204.16	3655.28
<b>Aluminum Base with Lumbar Adjustment</b>											
Mesh Back/Back Lock	SCTC-20-711	\$2219.21	\$2269.80	\$2324.04	\$2349.34	\$2371.03	\$2418.02	\$2461.38	\$2577.05	\$2680.06	\$2905.62
Knit Back/Back Lock	SCTC-20-711	2375.32	2425.91	2480.15	2505.45	2527.14	2574.13	2617.49	2733.16	2836.17	3061.73
Upholstered Back Jacket/Back Lock	SCTC-22-711	2408.97	2510.15	2618.63	2669.23	2712.61	2806.59	2893.31	3124.65	3330.67	3781.79

The following options require modification of the product number.

Leather Seat with Knit or Mesh Back	To specify, change the 5th digit to <b>1</b> ; <b>Example:</b> SCTC-10-0011
Leather Seat with Leather Upholstered Back Jacket	To specify, change the 5th digit to <b>1</b> and 6th digit to <b>1</b> ; <b>Example:</b> SCTC-11-0011
Faux Leather Seat with Knit or Mesh Back	To specify, change the 5th digit to <b>3</b> ; <b>Example:</b> SCTC-30-0011
Stain repellent	To specify, add <b>P</b> to end of the product number; <b>Example:</b> SCTC-20-0011 <b>P</b> (add <b>\$56.03</b> list)

**NOTE:** Stain repellent is available on SCTC-20 and SCTC-22 models only.

# Very Task

## Task Stool with Height Adjustable Arms



SCTC-20-4011

### Dimensions

- \*SH: 20-28"  
(508mm-711mm)
- H: 43-51"  
(1092mm-1295mm)
- D: 26"(660mm)
- W: 27"(686mm)
- \*SW: 19"(483mm)
- SD: 16"-19"  
(406mm-483mm)
- AH: 6.5"-10.5"  
(165mm-267mm)

\* Measurements taken with the BIFMA chair measuring device.

### Features

- Back: Knit, mesh only or mesh back with upholstered back jacket.
- Seat: Standard upholstered foam (3 lbs. polyurethane foam construction).
- Base: Plastic base or optional painted five-star aluminum or polished aluminum base.
- Arms: Height-adjustable arms with plastic uprights (black or fog) with soft arm caps. Height adjustment range of 4"(102mm).
- Mechanism: Balanced 3-point tilt; standard tilt tension.
- Back Lock: Single position upright back lock.
- Optional Asymmetrical Lumbar Adjustment: 4"(102mm) height adjustment; support level can be adjusted independently for right or left hand side of users body.
- Casters: Standard with hard black or two-tone casters; optional soft casters.
- Adjustable height foot ring.
- COM yardage / COL square footage:  
Mesh back model: 0.83/20  
Mesh back/upholstered back jacket: 1.5/40

**NOTE:** When specifying a back jacket; must also specify mesh surface color for outside of back. Back jacket is not field retrofittable. To add a back jacket in the field, see e-Parts for replacement back with an attached jacket.

### To Order, Specify:

1) Product number, including:

#### 1 Base/Caster Option:

##### Aluminum Base

- 1** Aluminum Std. Base, Hard Caster
- 2** Aluminum Std. Base, Soft Caster, add **\$59.01** to list
- T** Aluminum Std. Base, Two-Tone Casters

##### Plastic Base

- 5** Plastic Std. Base, Hard Caster
- 6** Plastic Std. Base, Soft Caster, add **\$59.01** to list
- P** Plastic Std. Base, Two-Tone Casters

2) Fabric surface and color (seat).

3) Knit or mesh surface and color (back).

4) Back Jacket (if applicable) Fabric surface and color.

5) Trim color (plastic components) (arm caps, control cover, adjustment levers, 4D or height adjustable arm uprights).

**Note:** If TR-UFM is specified, arm caps and adjustment levers default to TR-7 Fog. (Add **\$136.74** list for TR-UFM Snow.)

6) Frame trim color (aluminum components - underside of chair).

7) Base trim color (plastic or aluminum) dependent upon base style selected; TR-UFM Snow (plastic) and TR-FS Snowfall (aluminum) not available.

**Note:** If PM-P Polished Aluminum is selected for aluminum frame components (#6) or aluminum base (#7), or both, a total upcharge of **\$280.13** list will apply.

**Very Task**

Task Stool with Height Adjustable Arms

Upholstered Foam Seat Adjustments	Number ①	Fabric Grade								Leather Grade A	Leather Grade B
		A	B	C	D	E	F	G	H		
<b>Plastic Base</b>											
Mesh Back/Back Lock	SCTC-20-401	\$1911.95	\$1962.54	\$2016.78	\$2042.08	\$2063.77	\$2110.76	\$2154.12	\$2269.79	\$2372.80	\$2598.36
Knit Back/Back Lock	SCTC-20-401	2068.06	2118.65	2172.89	2198.19	2219.88	2266.87	2310.23	2425.90	2528.91	2754.47
Upholstered Back Jacket/Back Lock	SCTC-22-401	2101.71	2202.89	2311.37	2361.97	2405.35	2499.33	2586.05	2817.39	3023.41	3474.53
<b>Plastic Base with Lumbar Adjustment</b>											
Mesh Back/Back Lock	SCTC-20-411	\$2038.46	\$2089.05	\$2143.29	\$2168.59	\$2190.28	\$2237.27	\$2280.63	\$2396.30	\$2499.31	\$2724.87
Knit Back/Back Lock	SCTC-20-411	2194.57	2245.16	2299.40	2324.70	2346.39	2393.38	2436.74	2552.41	2655.42	2880.98
Upholstered Back Jacket/Back Lock	SCTC-22-411	2228.22	2329.40	2437.88	2488.48	2531.86	2625.84	2712.56	2943.90	3149.92	3601.04
<b>Aluminum Base</b>											
Mesh Back/Back Lock	SCTC-20-401	\$2002.33	\$2052.92	\$2107.16	\$2132.46	\$2154.15	\$2201.14	\$2244.50	\$2360.17	\$2463.18	\$2688.74
Knit Back/Back Lock	SCTC-20-401	2158.44	2209.03	2263.27	2288.57	2310.26	2357.25	2400.61	2516.28	2619.29	2844.85
Upholstered Back Jacket/Back Lock	SCTC-22-401	2192.09	2293.27	2401.75	2452.35	2495.73	2589.71	2676.43	2907.77	3113.79	3564.91
<b>Aluminum Base with Lumbar Adjustment</b>											
Mesh Back/Back Lock	SCTC-20-411	\$2128.84	\$2179.43	\$2233.67	\$2258.97	\$2280.66	\$2327.65	\$2371.01	\$2486.68	\$2589.69	\$2815.25
Knit Back/Back Lock	SCTC-20-411	2284.95	2335.54	2389.78	2415.08	2436.77	2483.76	2527.12	2642.79	2745.80	2971.36
Upholstered Back Jacket/Back Lock	SCTC-22-411	2318.60	2419.78	2528.26	2578.86	2622.24	2716.22	2802.94	3034.28	3240.30	3691.42

The following options require modification of the product number.

Leather Seat with Knit or Mesh Back

To specify, change the 5th digit to **1**; **Example:** SCTC-10-4011

Leather Seat with Leather Upholstered Back Jacket

To specify, change the 5th digit to **1** and 6th digit to **1**; **Example:** SCTC-11-4011

Faux Leather Seat with Knit or Mesh Back

To specify, change the 5th digit to **3**; **Example:** SCTC-30-4011

Stain repellent

To specify, add **P** to end of the product number; **Example:** SCTC-20-4011P (add \$56.03 list)

**NOTE:** Stain repellent is available on SCTC-20 and SCTC-22 models only.

# Very Task

## Task Stool with Fixed Arms



SCTC-20-1011

### Dimensions

- \*SH: 20-28"  
(508mm-711mm)
- H: 43-51"  
(1092mm-1295mm)
- D: 26"(660mm)
- W: 27"(686mm)
- \*SW: 19"(483mm)
- SD: 16"-19"  
(406mm-483mm)
- AH: 8"(203mm)

\* Measurements taken with the BIFMA chair measuring device.

### Features

- Back: Knit, mesh only or mesh back with upholstered back jacket.
- Seat: Standard upholstered foam (3 lbs. polyurethane foam construction).
- Seat Type: Standard adjustable 3"(76mm) range.
- Base: Plastic base or optional painted five-star aluminum or polished aluminum base.
- Arms: Fixed height arms with aluminum uprights in either painted or polished, soft arm caps.
- Mechanism: Balanced 3-point tilt; standard tilt tension.
- Back Lock: Single position upright back lock.
- Optional Asymmetrical Lumbar Adjustment: 4"(102mm) height adjustment; support level can be adjusted independently for right or left hand side of users body.
- Casters: Standard with hard black or two-tone casters; optional soft casters.
- Adjustable height foot ring.
- COM yardage / COL square footage:  
Mesh back model: 0.83/20  
Mesh back/upholstered back jacket: 1.5/40

**NOTE:** When specifying a back jacket; must also specify mesh surface color for outside of back. Back jacket is not field retrofittable. To add a back jacket in the field, see e-Parts for replacement back with an attached jacket.

### To Order, Specify:

1) Product number, including:

#### 1 Base/Caster Option:

##### Aluminum Base

- 1** Aluminum Std. Base, Hard Caster
- 2** Aluminum Std. Base, Soft Caster, add **\$59.01** to list
- T** Aluminum Std. Base, Two-Tone Casters

##### Plastic Base

- 5** Plastic Std. Base, Hard Caster
- 6** Plastic Std. Base, Soft Caster, add **\$59.01** to list
- P** Plastic Std. Base, Two-Tone Casters

2) Fabric surface and color (seat).

3) Knit or mesh surface and color (back).

4) Back Jacket (if applicable) Fabric surface and color.

5) Trim color (plastic components) (arm caps, control cover, adjustment levers, 4D or height adjustable arm uprights).

**Note:** If TR-UFM is specified, arm caps and adjustment levers default to TR-7 Fog. (Add **\$136.74** list for TR-UFM Snow.)

6) Frame trim color (aluminum components - underside of chair).

7) Base trim color (plastic or aluminum) dependent upon base style selected; TR-UFM Snow (plastic) and TR-FS Snowfall (aluminum) not available.

**Note:** If PM-P Polished Aluminum is selected for aluminum frame components (#6) or aluminum base (#7), or both, a total upcharge of **\$280.13** list will apply.

**Very Task**

Task Stool with Fixed Arms

Upholstered Foam Seat Adjustments	Number ①	Fabric Grade								Leather Grade A	Leather Grade B
		A	B	C	D	E	F	G	H		
<b>Plastic Base</b>											
Mesh Back/Back Lock	SCTC-20-101	\$1893.87	\$1944.46	\$1998.70	\$2024.00	\$2045.69	\$2092.68	\$2136.04	\$2251.71	\$2354.72	\$2580.28
Knit Back/Back Lock	SCTC-20-101	2049.98	2100.57	2154.81	2180.11	2201.80	2248.79	2292.15	2407.82	2510.83	2736.39
Upholstered Back Jacket/Back Lock	SCTC-22-101	2083.63	2184.81	2293.29	2343.89	2387.27	2481.25	2567.97	2799.31	3005.33	3456.45
<b>Plastic Base with Lumbar Adjustment</b>											
Mesh Back/Back Lock	SCTC-20-111	\$2020.38	\$2070.97	\$2125.21	\$2150.51	\$2172.20	\$2219.19	\$2262.55	\$2378.22	\$2481.23	\$2706.79
Knit Back/Back Lock	SCTC-20-111	2176.49	2227.08	2281.32	2306.62	2328.31	2375.30	2418.66	2534.33	2637.34	2862.90
Upholstered Back Jacket/Back Lock	SCTC-22-111	2210.14	2311.32	2419.80	2470.40	2513.78	2607.76	2694.48	2925.82	3131.84	3582.96
<b>Aluminum Base</b>											
Mesh Back/Back Lock	SCTC-20-101	\$1984.25	\$2034.84	\$2089.08	\$2114.38	\$2136.07	\$2183.06	\$2226.42	\$2342.09	\$2445.10	\$2670.66
Knit Back/Back Lock	SCTC-20-101	2140.36	2190.95	2245.19	2270.49	2292.18	2339.17	2382.53	2498.20	2601.21	2826.77
Upholstered Back Jacket/Back Lock	SCTC-22-101	2174.01	2275.19	2383.67	2434.27	2477.65	2571.63	2658.35	2889.69	3095.71	3546.83
<b>Aluminum Base with Lumbar Adjustment</b>											
Mesh Back/Back Lock	SCTC-20-111	\$2110.76	\$2161.35	\$2215.59	\$2240.89	\$2262.58	\$2309.57	\$2352.93	\$2468.60	\$2571.61	\$2797.17
Knit Back/Back Lock	SCTC-20-111	2266.87	2317.46	2371.70	2397.00	2418.69	2465.68	2509.04	2624.71	2727.72	2953.28
Upholstered Back Jacket/Back Lock	SCTC-22-111	2300.52	2401.70	2510.18	2560.78	2604.16	2698.14	2784.86	3016.20	3222.22	3673.34

The following options require modification of the product number.

Leather Seat with Knit or Mesh Back

To specify, change the 5th digit to **1**; **Example:** SCTC-10-1011

Leather Seat with Leather Upholstered Back Jacket

To specify, change the 5th digit to **1** and 6th digit to **1**; **Example:** SCTC-11-1011

Faux Leather Seat with Knit or Mesh Back

To specify, change the 5th digit to **3**; **Example:** SCTC-30-1011

Stain repellent

To specify, add **P** to end of the product number; **Example:** SCTC-20-1011P (add **\$56.03** list)

**NOTE:** Stain repellent is available on SCTC-20 and SCTC-22 models only.

# Very Task

## Task Stool without Arms



SCTC-20-0011

### Dimensions

- \*SH: 20-28"  
(508mm-711mm)
- H: 43-51"  
(1092mm-12958mm)
- D: 26"(660mm)
- W: 27"(686mm)
- \*SW: 19"(483mm)
- SD: 16"-19"  
(406mm-483mm)

\* Measurements taken with the BIFMA chair measuring device.

### Features

- Back: Knit, mesh only or mesh back with upholstered back jacket.
- Seat: Standard upholstered foam (3 lbs. polyurethane foam construction).
- Seat Type: Standard adjustable 3"(76mm) range.
- Base: Plastic base or optional painted five-star aluminum or polished aluminum base.
- Mechanism: Balanced 3-point tilt; standard tilt tension.
- Back Lock: Single position upright back lock.
- Optional Asymmetrical Lumbar Adjustment: 4"(102mm) height adjustment; support level can be adjusted independently for right or left hand side of users body.
- Casters: Standard with hard black or two-tone casters; optional soft casters.
- Adjustable height foot ring.
- COM yardage / COL square footage:  
Mesh back model: 0.83/20  
Mesh back/upholstered back jacket: 1.5/40

**NOTE:** When specifying a back jacket; must also specify mesh surface color for outside of back. Back jacket is not field retrofittable. To add a back jacket in the field, see e-Parts for replacement back with an attached jacket.

### To Order, Specify:

- 1) Product number, including:

#### 1 Base/Caster Option:

##### Aluminum Base

- 1** Aluminum Std. Base, Hard Caster
- 2** Aluminum Std. Base, Soft Caster, add **\$59.01** to list
- T** Aluminum Std. Base, Two-Tone Casters

##### Plastic Base

- 5** Plastic Std. Base, Hard Caster
- 6** Plastic Std. Base, Soft Caster, add **\$59.01** to list
- P** Plastic Std. Base, Two-Tone Casters

- 2) Fabric surface and color (seat).
- 3) Knit or mesh surface and color (back).
- 4) Back Jacket (if applicable) Fabric surface and color.
- 5) Trim color (plastic components) (arm caps, control cover, adjustment levers, 4D or height adjustable arm uprights).

**Note:** If TR-UFM is specified, arm caps and adjustment levers default to TR-7 Fog. (Add **\$136.74** list for TR-UFM Snow.)

- 6) Frame trim color (aluminum components - underside of chair).
- 7) Base trim color (plastic or aluminum) dependent upon base style selected; TR-UFM Snow (plastic) and TR-FS Snowfall (aluminum) not available.

**Note:** If PM-P Polished Aluminum is selected for aluminum frame components (#6) or aluminum base (#7), or both, a total upcharge of **\$280.13** list will apply.



**Very Task**

Task Stool without Arms

Upholstered Foam Seat Adjustments	Number ①	Fabric Grade								Leather Grade A	Leather Grade B
		A	B	C	D	E	F	G	H		
<b>Plastic Base</b>											
Mesh Back/Back Lock	SCTC-20-001	\$1686.05	\$1736.64	\$1790.88	\$1816.18	\$1837.87	\$1884.86	\$1928.22	\$2043.89	\$2146.90	\$2372.46
Knit Back/Back Lock	SCTC-20-001	1842.16	1892.75	1946.99	1972.29	1993.98	2040.97	2084.33	2200.00	2303.01	2528.57
Upholstered Back Jacket/Back Lock	SCTC-22-001	1875.81	1976.99	2085.47	2136.07	2179.45	2273.43	2360.15	2591.49	2797.51	3248.63
<b>Plastic Base with Lumbar Adjustment</b>											
Mesh Back/Back Lock	SCTC-20-011	\$1812.56	\$1863.15	\$1917.39	\$1942.69	\$1964.38	\$2011.37	\$2054.73	\$2170.40	\$2273.41	\$2498.97
Knit Back/Back Lock	SCTC-20-011	1968.67	2019.26	2073.50	2098.80	2120.49	2167.48	2210.84	2326.51	2429.52	2655.08
Upholstered Back Jacket/Back Lock	SCTC-22-011	2002.32	2103.50	2211.98	2262.58	2305.96	2399.94	2486.66	2718.00	2924.02	3375.14
<b>Aluminum Base</b>											
Mesh Back/Back Lock	SCTC-20-001	\$1776.43	\$1827.02	\$1881.26	\$1906.56	\$1928.25	\$1975.24	\$2018.60	\$2134.27	\$2237.28	\$2462.84
Knit Back/Back Lock	SCTC-20-001	1932.54	1983.13	2037.37	2062.67	2084.36	2131.35	2174.71	2290.38	2393.39	2618.95
Upholstered Back Jacket/Back Lock	SCTC-22-001	1966.19	2067.37	2175.85	2226.45	2269.83	2363.81	2450.53	2681.87	2887.89	3339.01
<b>Aluminum Base with Lumbar Adjustment</b>											
Mesh Back/Back Lock	SCTC-20-011	\$1902.94	\$1953.53	\$2007.77	\$2033.07	\$2054.76	\$2101.75	\$2145.11	\$2260.78	\$2363.79	\$2589.35
Knit Back/Back Lock	SCTC-20-011	2059.05	2109.64	2163.88	2189.18	2210.87	2257.86	2301.22	2416.89	2519.90	2745.46
Upholstered Back Jacket/Back Lock	SCTC-22-011	2092.70	2193.88	2302.36	2352.96	2396.34	2490.32	2577.04	2808.38	3014.40	3465.52

The following options require modification of the product number.

Leather Seat with Knit or Mesh Back

To specify, change the 5th digit to **1**; **Example:** SCTC-10-0011

Leather Seat with Leather Upholstered Back Jacket

To specify, change the 5th digit to **1** and 6th digit to **1**; **Example:** SCTC-11-0011

Faux Leather Seat with Knit or Mesh Back

To specify, change the 5th digit to **3**; **Example:** SCTC-30-0011

Stain repellent

To specify, add **P** to end of the product number; **Example:** SCTC-20-0011**P** (add **\$56.03** list)

**NOTE:** Stain repellent is available on SCTC-20 and SCTC-22 models only.

This page intentionally blank

# Very Wire Stacker

## General Specifications

### Features and Options (Wire Stacker and Wire Stool)

#### Wire Stacker Chair

- 11mm solid steel rod frame
- Single piece high-strength polymer shell seat and back
- Clear nylon glides
- Frame finishes include: painted or Trivalent chrome
- Optional upholstered foam pad on seat or seat and back
- Fog or black trim arm caps
- Arm or armless version available
- Arm chair stacks 5-high on the floor or 15-high on a cart. Dimensions for 15-high on cart: 54"(1372mm)H x 55"(1397mm)D x 24"(610mm)W.
- Armless stacks 10-high on the floor, upholstered or non-upholstered; stacks 30-high non-upholstered on a cart (63.5"(1613mm)H x 37"(940mm)D x 24"(610mm)W); stacks 25-high upholstered on a cart (61"(1549mm)H x 40.5"(1029mm)D x 24"(610mm)W).
- Seat: Stitched double seams. Vertically in the center and on the edges of the leather seat cushion.
- Ganging option: arm chair to armless, armless to armless.
- Chairs with arms: 16 lbs.
- Chairs without arms: 15 lbs.

#### Wire Stacker Stool

- Chrome frame
- Stacks 5-high on the floor.
- Single piece high-strength polymer shell seat and back
- Clear nylon glides
- Fog or black trim arm caps
- Arm or armless version available

### General Guidelines for Product Specification

	<u>S</u>	<u>C</u>	<u>H</u>	<u>-</u>	<u>2</u>	<u>2</u>	<u>-</u>	<u>3</u>	<u>S</u>	<u>E</u>	<u>3A-18</u>	<u>3A-18</u>	<u>TR-FA</u>	<u>TR-F</u>	<u>KR-V</u>
Product Type															
(S) Seating															
Product Line															
(C) Very															
Model															
(H) Wire Stack															
(W) Stool															
Seat Upholstery															
(1) Leather															
(2) Fabric															
(3) Faux Leather															
(4) Polymer															
Back Upholstery															
(1) Leather															
(2) Fabric															
(3) Faux Leather															
(4) Polymer															
Arm/Caps															
(0) No Arms															
(3) Fixed Arms, Hard Caps															
Base Frame															
(9) Plastic Glide, Ganging*															
(S) Plastic Glide, Non-ganging*															
Enhanced Upholstery															
Seat Upholstery															
Tellure															
Back Upholstery															
Tellure															
Shell Color															
Tomato															
Trim Color															
Black															
Frame Trim Color															
Trivalent Chrome															

\*Wire Stacker Chair only

# Very

## Wire Stacker

### With Arms



SCH-44-35

### Dimensions

\*SH: 17.3"(440mm)  
 H: 30.6"(778mm)  
 D: 23.3"(591mm)  
 W: 23"(584mm)  
 \*SW: 18.8"(476mm)  
 \*SD: 17.3"(439mm)  
 \*AH: 8.5"(216mm)  
 Between Arms:  
 19.2"(487mm)

\* All measurements taken with the BIFMA chair measuring device.

### Features

- 11 mm steel rod frame.
- Single high-strength polymer shell seat and back with an optional upholstery pad.
- Upholstered seat features 0.5"(12.7mm) foam pad.
- Upholstered back features 0.5"(12.7mm) foam pad.
- Arms: Black or Fog glass-filled polypropylene arm caps.
- Frame: Available painted or trivalent chrome.
- High impact clear nylon glides available with or without ganging option.
- Stacks 5-high on the floor or 15-high on a cart. See page 131 for dimensions.
- Ganging option: Arm to armless, armless to armless.
- COM yardage / COL square footage:  
 Fully Upholstered: 1.5/17.0  
 Upholstered seat: 0.8/10.6

### To Order, Specify:

1) Product number, including;

#### 1 Seat or Seat Pad Option:

- 1 Leather
- 2 Fabric
- 3 Faux Leather
- 4 Polymer

#### 2 Back or Back Pad Option:

- 1 Leather
- 2 Fabric
- 3 Faux Leather
- 4 Polymer

- 2) Fabric surface and color (seat).
- 3) Fabric surface and color (back).
- 4) Shell color - required for upholstered and non-upholstered.
- 5) Trim for arm caps and plastic components.
- 6) Frame trim color.

Ganging	Number 1 2	Price	Fabric Grade			C	D	E	F	G	H	Leather Grade A	Leather Grade B
			A	B									
<b>Polymer Shell Without Optional Upholstered Pad</b>													
Non-Ganging	SCH- 4 4 -3S	\$440.14	N/A	N/A	N/A	N/A	N/A	N/A	N/A	N/A	N/A	N/A	N/A
Ganging Glide	SCH- 4 4 -39	456.85	N/A	N/A	N/A	N/A	N/A	N/A	N/A	N/A	N/A	N/A	N/A
<b>Polymer Shell With Upholstered Seat Pad</b>													
Non-Ganging	SCH- 4 -3SE	N/A	\$563.26	\$617.14	\$674.69	\$700.71	\$ 724.80	\$ 773.12	\$ 819.53	\$ 942.12	\$ 812.11	\$1034.67	
Ganging Glide	SCH- 4 -39E	N/A	579.97	633.85	691.40	717.42	741.51	789.83	836.24	958.83	828.82	1051.38	
<b>Polymer Shell With Upholstered Seat and Back Pads</b>													
Non-Ganging	SCH- -3SE	N/A	\$676.30	\$784.06	\$899.16	\$951.20	\$ 999.38	\$1096.02	\$1188.84	\$1434.02	\$1174.00	\$1619.12	
Ganging Glide	SCH- -39E	N/A	693.01	800.77	915.87	967.91	1016.09	1112.73	1205.55	1450.73	1190.71	1635.83	

The following options require modification of the product number.

Stain repellent

To specify, add **P** to end of the product number (add \$56.75 list)

**NOTE:** Stain repellent is available on SCH-22 or SCH-24 models only.

For available fabrics, refer to [surfaces.haworth.com](http://surfaces.haworth.com).

# Very

Wire Stacker

**Without Arms**



SCH-44-05

**Dimensions**

- \*SH: 17.3"(440mm)
- H: 30.6"(778mm)
- D: 23.3"(591mm)
- W: 21.8"(554mm)
- \*SW: 18.8"(476mm)
- \*SD: 17.3"(439mm)

\* All measurements taken with the BIFMA chair measuring device.

**Features**

- 11 mm steel rod frame.
- Single piece high-strength polymer shell seat and back with an optional upholstery pad.
- Upholstered seat features 0.5"(12.7mm) foam pad.
- Upholstered back features 0.5"(12.7mm) foam pad.
- Frame: Available painted or trivalent chrome.
- High impact clear nylon glides available with or without ganging option.
- Stacks 10-high on the floor, upholstered or non-upholstered; stacks 30-high non-upholstered on a cart; stacks 25-high upholstered on a cart. See page 131 for dimensions.
- Ganging option: Arm to armless, armless to armless.
- COM yardage / COL square footage:  
Fully Upholstered: 1.5/17.0  
Upholstered seat: 0.8/10.6

**To Order, Specify:**

1) Product number, including;

**1 Seat or Seat Pad Option:**

- 1 Leather
- 2 Fabric
- 3 Faux Leather
- 4 Polymer

**2 Back or Back Pad Option:**

- 1 Leather
- 2 Fabric
- 3 Faux Leather
- 4 Polymer

- 2) Fabric surface and color (seat).
- 3) Fabric surface and color (back).
- 4) Shell color - required for upholstered and non-upholstered.
- 5) Frame trim color.

Ganging	Number 1 2	Price	Fabric Grade		C	D	E	F	G	H	Leather Grade A	Leather Grade B
			A	B								
<b>Polymer Shell Without Optional Upholstered Pad</b>												
Non-Ganging	SCH- 4 4 -05	\$343.58	N/A	N/A	N/A	N/A	N/A	N/A	N/A	N/A	N/A	N/A
Ganging Glide	SCH- 4 4 -09	360.29	N/A	N/A	N/A	N/A	N/A	N/A	N/A	N/A	N/A	N/A
<b>Polymer Shell With Upholstered Seat Pad</b>												
Non-Ganging	SCH- 4 -05E	N/A	\$466.70	\$520.58	\$578.13	\$604.15	\$628.24	\$ 676.56	\$ 722.97	\$ 845.56	\$ 715.55	\$ 938.11
Ganging Glide	SCH- 4 -09E	N/A	483.41	537.29	594.84	620.86	644.95	693.27	739.68	862.27	732.26	954.82
<b>Polymer Shell With Upholstered Seat and Back Pads</b>												
Non-Ganging	SCH- -05E	N/A	\$579.74	\$687.50	\$802.60	\$854.64	\$902.82	\$ 999.46	\$1092.28	\$1337.46	\$1077.44	\$1522.56
Ganging Glide	SCH- -09E	N/A	596.45	704.21	819.31	871.35	919.53	1016.17	1108.99	1354.17	1094.15	1539.27

The following options require modification of the product number.

Stain repellent

To specify, add **P** to end of the product number (add **\$56.75** list)

**NOTE:** Stain repellent is available on SCH-22 or SCH-24 models only.

For available fabrics, refer to [surfaces.haworth.com](http://surfaces.haworth.com).

# Very

## Bar Height Wire Stool

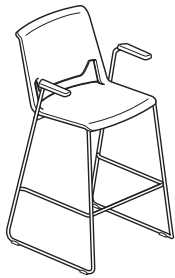

SCW-44-3S

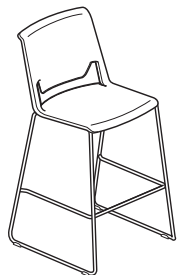

SCW-44-0S

### Dimensions

SH: 29.75"(756mm)  
 H: 43"(1092mm)  
 D: 23"(587mm)  
 W: 23"(587mm)  
 SW: 18.68"(475mm)  
 SD: 17.3"(439mm)  
 AH: 8.5"(216mm)  
 Between Arms:  
 19.2"(488mm)

### Features

- 11 mm steel rod frame.
- Single piece high-strength polymer shell seat and back with an optional upholstery pad.
- 10 shell color options.
- Upholstered seat features 0.5"(12.7mm) foam pad.
- Upholstered back features 0.5"(12.7mm) foam pad.
- Arms: Black or Fog glass-filled polypropylene arm caps.
- Base: trivalent chrome.
- High impact clear nylon glides.
- Stacks 5-high on the floor.
- The foot rest is 11.84"(300.7mm) from the floor.
- COM yardage / COL square footage:  
 Fully Upholstered: 1.5/12.5  
 Upholstered seat: .8/7.5

### To Order, Specify:

1) Product number.

#### 1 Seat or Seat Pad Option:

- 1 Leather
- 2 Fabric
- 3 Faux Leather
- 4 Polymer

#### 2 Back or Back Pad Option:

- 1 Leather
- 2 Fabric
- 3 Faux Leather
- 4 Polymer

- 2) Fabric surface and color (seat).
- 3) Fabric surface and color (back).
- 4) Shell color - required for upholstered and non-upholstered.
- 5) Trim for arm caps (if specified).
- 6) Frame trim color (KR-V only).

Description	Number 1 2	Price	Fabric Grade		C	D	E	F	G	H	Leather Grade A	Leather Grade B
			A	B								
<b>Polymer Shell Without Optional Upholstered Pad</b>												
With Arms	SCW- 44 -3S	\$746.55	N/A	N/A	N/A	N/A	N/A	N/A	N/A	N/A	N/A	N/A
Without Arms	SCW- 44 -0S	649.99	N/A	N/A	N/A	N/A	N/A	N/A	N/A	N/A	N/A	N/A
<b>Polymer Shell With Upholstered Seat Pad</b>												
With Arms	SCW- 4 -3SE	N/A	\$869.67	\$ 923.55	\$ 981.10	\$1007.12	\$1031.21	\$1079.53	\$1125.94	\$1248.53	\$1118.52	\$1341.08
Without Arms	SCW- 4 -0SE	N/A	773.11	826.99	884.54	910.56	934.65	982.97	1029.38	1151.97	1021.96	1244.52
<b>Polymer Shell With Upholstered Seat and Back Pads</b>												
With Arms	SCW- 4 -3SE	N/A	\$982.71	\$1090.47	\$1205.57	\$1257.61	\$1305.79	\$1402.43	\$1495.25	\$1740.43	\$1480.41	\$1925.53
Without Arms	SCW- 4 -0SE	N/A	886.15	993.91	1109.01	1161.05	1209.23	1305.87	1398.69	1643.87	1383.85	1828.97

The following options require modification of the product number.

Stain repellent

To specify, add **P** to end of the product number (add **\$56.75** list)

**NOTE:** Stain repellent is available on SCW-22 or SCW-24 models only.

For available fabrics, refer to [surfaces.haworth.com](http://surfaces.haworth.com).

# Very

## Counter Height Wire Stool

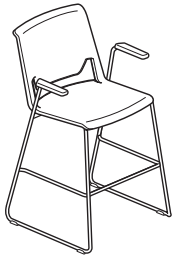

SCWC-44-3S

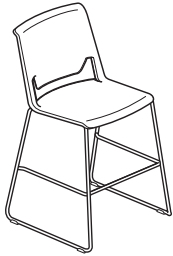

SCWC-44-0S

### Dimensions

SH: 25.75"(654mm)  
 H: 39"(991mm)  
 D: 23"(587mm)  
 W: 23"(587mm)  
 SW: 18.68"(475mm)  
 SD: 17.3"(439mm)  
 AH: 8.5"(216mm)  
 Between Arms:  
 19.2"(488mm)

### Features

- 11 mm steel rod frame.
- Single piece high-strength polymer shell seat and back with an optional upholstery pad.
- 10 shell color options.
- Upholstered seat features 0.5"(12.7mm) foam pad.
- Upholstered back features 0.5"(12.7mm) foam pad.
- Arms: Black or Fog glass-filled polypropylene arm caps.
- Base: trivalent chrome.
- High impact clear nylon glides.
- Stacks 5-high on the floor.
- The foot rest is 7.84"(199.1mm) from the floor.
- COM yardage / COL square footage:  
 Fully Upholstered: 1.5/12.5  
 Upholstered seat: .8/7.5

### To Order, Specify:

1) Product number.

#### 1 Seat or Seat Pad Option:

- 1 Leather
- 2 Fabric
- 3 Faux Leather
- 4 Polymer

#### 2 Back or Back Pad Option:

- 1 Leather
- 2 Fabric
- 3 Faux Leather
- 4 Polymer

- 2) Fabric surface and color (seat).
- 3) Fabric surface and color (back).
- 4) Shell color - required for upholstered and non-upholstered.
- 5) Trim for arm caps (if specified).
- 6) Frame trim color (KR-V only).

Description	Number 1 2	Price	Fabric Grade								Leather Grade A	Leather Grade B	
			A	B	C	D	E	F	G	H			
<b>Polymer Shell Without Optional Upholstered Pad</b>													
With Arms	SCWC- 44 -3S	\$746.55	N/A	N/A	N/A	N/A	N/A	N/A	N/A	N/A	N/A	N/A	N/A
Without Arms	SCWC- 44 -0S	649.99	N/A	N/A	N/A	N/A	N/A	N/A	N/A	N/A	N/A	N/A	N/A
<b>Polymer Shell With Upholstered Seat Pad</b>													
With Arms	SCWC- 4 -3SE	N/A	\$869.67	\$ 923.55	\$ 981.10	\$1007.12	\$1031.21	\$1079.53	\$1125.94	\$1248.53	\$1118.52	\$1341.08	
Without Arms	SCWC- 4 -0SE	N/A	773.11	826.99	884.54	910.56	934.65	982.97	1029.38	1151.97	1021.96	1244.52	
<b>Polymer Shell With Upholstered Seat and Back Pads</b>													
With Arms	SCWC- 4 -3SE	N/A	\$982.71	\$1090.47	\$1205.57	\$1257.61	\$1305.79	\$1402.43	\$1495.25	\$1740.43	\$1480.41	\$1925.53	
Without Arms	SCWC- 4 -0SE	N/A	886.15	993.91	1109.01	1161.05	1209.23	1305.87	1398.69	1643.87	1383.85	1828.97	

The following options require modification of the product number.

Stain repellent

To specify, add **P** to end of the product number (add **\$56.75** list)

**NOTE:** Stain repellent is available on SCWC-22 or SCWC-24 models only.

For available fabrics, refer to [surfaces.haworth.com](http://surfaces.haworth.com).

# Very Perforated Side, Seminar and Side Stool

## General Specifications

### Features and Options

#### (Side, Seminar and Side Chair)

#### Side and Seminar Chair

- Back: High-strength polymer back with perforations for added flexibility and an optional upholstered foam pad
- Seat: High-strength polymer seat with an optional upholstered foam pad
- Casters: Hard (black), soft (black) or two-tone (fog and gray)
- Glides: Plastic or felt
- Frame finishes include: painted or trivalent chrome
- Weight assisted recline mechanism (Seminar model only)
- Fog or black trim arm caps and glides available
- Arm or armless version available
- Optional Laminate Tablet arm
- Optional Storage rack
- Stacking cart (8-high capacity)
- Stacks 5-high on the floor or 8-high non-upholstered and 6-high upholstered (arms - 69" high x 46" deep x 24" wide), (armless - 57" high x 44" deep x 24" wide) on cart.
- 22mm 14-gauge steel leg tube
- Seminar Chair with intuitive reclining back.

#### Side Stool

- Back: High-strength polymer back with perforations for added flexibility and an optional upholstered foam pad
- Seat: High-strength polymer seat with an optional upholstered polyurethane foam pad
- Glides: Plastic or felt
- Frame finishes include: painted or trivalent chrome
- Fog or black trim arm caps and glides available
- Arm or armless version available
- Stacks 5-high on the floor

### General Guidelines for Product Specification

	S	C	M	-	2	2	-	3	1	E	3A-18	3A-18	TR-FA	TR-F	TR-LE
Product Type	_____	_____	_____	_____	_____	_____	_____	_____	_____	_____	_____	_____	_____	_____	_____
(S) Seating	_____	_____	_____	_____	_____	_____	_____	_____	_____	_____	_____	_____	_____	_____	_____
Product Line	_____	_____	_____	_____	_____	_____	_____	_____	_____	_____	_____	_____	_____	_____	_____
(C) Very	_____	_____	_____	_____	_____	_____	_____	_____	_____	_____	_____	_____	_____	_____	_____
Model	_____	_____	_____	_____	_____	_____	_____	_____	_____	_____	_____	_____	_____	_____	_____
(M) Seminar	_____	_____	_____	_____	_____	_____	_____	_____	_____	_____	_____	_____	_____	_____	_____
(S) Side	_____	_____	_____	_____	_____	_____	_____	_____	_____	_____	_____	_____	_____	_____	_____
(L) Side Stool	_____	_____	_____	_____	_____	_____	_____	_____	_____	_____	_____	_____	_____	_____	_____
Seat Upholstery	_____	_____	_____	_____	_____	_____	_____	_____	_____	_____	_____	_____	_____	_____	_____
(1) Leather	_____	_____	_____	_____	_____	_____	_____	_____	_____	_____	_____	_____	_____	_____	_____
(2) Fabric	_____	_____	_____	_____	_____	_____	_____	_____	_____	_____	_____	_____	_____	_____	_____
(3) Faux Leather	_____	_____	_____	_____	_____	_____	_____	_____	_____	_____	_____	_____	_____	_____	_____
(4) Polymer	_____	_____	_____	_____	_____	_____	_____	_____	_____	_____	_____	_____	_____	_____	_____
Back Upholstery	_____	_____	_____	_____	_____	_____	_____	_____	_____	_____	_____	_____	_____	_____	_____
(1) Leather	_____	_____	_____	_____	_____	_____	_____	_____	_____	_____	_____	_____	_____	_____	_____
(2) Fabric	_____	_____	_____	_____	_____	_____	_____	_____	_____	_____	_____	_____	_____	_____	_____
(3) Faux Leather	_____	_____	_____	_____	_____	_____	_____	_____	_____	_____	_____	_____	_____	_____	_____
(4) Polymer	_____	_____	_____	_____	_____	_____	_____	_____	_____	_____	_____	_____	_____	_____	_____
Arm/Caps	_____	_____	_____	_____	_____	_____	_____	_____	_____	_____	_____	_____	_____	_____	_____
(0) No Arms	_____	_____	_____	_____	_____	_____	_____	_____	_____	_____	_____	_____	_____	_____	_____
(3) Fixed Arms, Hard Caps	_____	_____	_____	_____	_____	_____	_____	_____	_____	_____	_____	_____	_____	_____	_____
Base/Caster	_____	_____	_____	_____	_____	_____	_____	_____	_____	_____	_____	_____	_____	_____	_____
(H) 4-Leg, Plastic Glides	_____	_____	_____	_____	_____	_____	_____	_____	_____	_____	_____	_____	_____	_____	_____
(K) 4-Leg, Felt Glides	_____	_____	_____	_____	_____	_____	_____	_____	_____	_____	_____	_____	_____	_____	_____
(1) 4-Leg, Hard Casters*	_____	_____	_____	_____	_____	_____	_____	_____	_____	_____	_____	_____	_____	_____	_____
(2) 4-Leg, Soft Casters*	_____	_____	_____	_____	_____	_____	_____	_____	_____	_____	_____	_____	_____	_____	_____
(T) 4-Leg, Two-Tone Casters*	_____	_____	_____	_____	_____	_____	_____	_____	_____	_____	_____	_____	_____	_____	_____
Enhanced Upholstery	_____	_____	_____	_____	_____	_____	_____	_____	_____	_____	_____	_____	_____	_____	_____
Seat Upholstery	_____	_____	_____	_____	_____	_____	_____	_____	_____	_____	_____	_____	_____	_____	_____
Tellure	_____	_____	_____	_____	_____	_____	_____	_____	_____	_____	_____	_____	_____	_____	_____
Back Upholstery	_____	_____	_____	_____	_____	_____	_____	_____	_____	_____	_____	_____	_____	_____	_____
Tellure	_____	_____	_____	_____	_____	_____	_____	_____	_____	_____	_____	_____	_____	_____	_____
Shell Color	_____	_____	_____	_____	_____	_____	_____	_____	_____	_____	_____	_____	_____	_____	_____
Tomato	_____	_____	_____	_____	_____	_____	_____	_____	_____	_____	_____	_____	_____	_____	_____
Trim Color	_____	_____	_____	_____	_____	_____	_____	_____	_____	_____	_____	_____	_____	_____	_____
Black	_____	_____	_____	_____	_____	_____	_____	_____	_____	_____	_____	_____	_____	_____	_____
Frame Trim Color	_____	_____	_____	_____	_____	_____	_____	_____	_____	_____	_____	_____	_____	_____	_____
Metallic Silver	_____	_____	_____	_____	_____	_____	_____	_____	_____	_____	_____	_____	_____	_____	_____

\*Side and Seminar chairs only.



# Very

## Side Chair – Perforated Back

**With Arms**

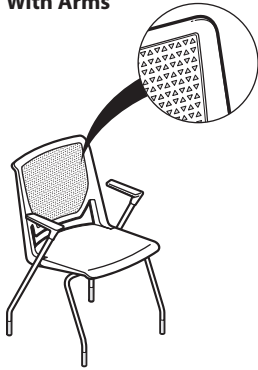

SCS-44-3H

**Dimensions**

- \*SH: 18.2”(461mm)
- H: 33.9”(861mm)
- D: 22”(559mm)
- W: 23.5”(597mm)
- \*SW: 19.2”(487mm)
- \*SD: 17.5”(443mm)
- \*AH: 8.9”(226mm)
- Between Arms:  
19.6”(498mm)

\* All measurements taken with the BIFMA chair measuring device.

**Features**

- Back: High-strength polymer back with flexing perforations and an optional upholstered foam pad.
- Seat: High-strength polymer seat with an optional upholstery pad.
- Upholstered seat features 1”(25.4mm) foam pad.
- Upholstered back features 0.5”(12.7mm) foam pad.
- Arms: Black or Fog glass-filled polypropylene arm caps.
- Frame: Available painted or trivalent chrome.
- Casters: Hard (black), soft (black) or two-tone (fog and gray).
- Glides: Plastic or felt.
- Stacks 5-high on the floor and 8-high non-upholstered or 6-high upholstered on a cart with glides and casters.
- COM yardage / COL square footage:  
Fully Upholstered: 1.5/17.0  
Upholstered seat: 0.75/9.5

**To Order, Specify:**

- 1) Product number, including;
  - 1** Seat or Seat Pad Option:
    - 1** Leather
    - 2** Fabric
    - 3** Faux Leather
    - 4** Polymer
  - 2** Back or Back Pad Option:
    - 1** Leather
    - 2** Fabric
    - 3** Faux Leather
    - 4** Polymer
  - 3** Glide or Caster Option:
    - H** Plastic Glide
    - K** Felt Glide
    - 1** Hard Casters, add **\$65.91** list
    - 2** Soft Casters, add **\$125.93** list
    - T** Two-Tone Casters, add **\$65.91** list
- 2) Fabric surface and color (seat).
- 3) Fabric surface and color (back).
- 4) Shell color – required for upholstered and non-upholstered.
- 5) Trim for arm caps, glides and plastic components.
- 6) Frame trim color.  
Trivalent Chrome (KR-V) add **\$283.73** list.

Number <b>1 2 3</b>	Price	Fabric Grade		C	D	E	F	G	H	Leather Grade A	Leather Grade B	
		A	B									
<b>Without Optional Upholstered Pad</b>												
SCS- 4 4 -3	\$508.89	N/A	N/A	N/A	N/A	N/A	N/A	N/A	N/A	N/A	N/A	
<b>With Upholstered Seat Pad</b>												
SCS- 4 -3 E	N/A	\$631.46	\$684.56	\$741.31	\$ 766.93	\$ 790.69	\$ 838.33	\$ 884.07	\$1004.91	\$ 876.75	\$1096.13	
<b>With Upholstered Seat and Back Pads</b>												
SCS- 4 -3 E	N/A	\$745.73	\$851.93	\$965.43	\$1016.67	\$1064.19	\$1159.47	\$1250.95	\$1492.63	\$1236.31	\$1675.07	

The following options require modification of the product number.  
Stain repellent To specify, add **P** to end of the product number (add **\$56.75** list)

**NOTE:** Stain repellent is available on SCS-22 and SCS-24 models only.  
For available fabrics, refer to [surfaces.haworth.com](http://surfaces.haworth.com).

# Very

## Side Chair – Perforated Back

### Without Arms

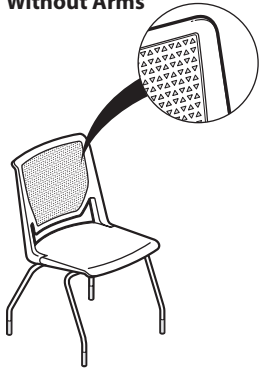

SCS-44-0H

### Dimensions

- \*SH: 18.2"(461mm)
- H: 33.9"(861mm)
- D: 22"(559mm)
- W: 22.3"(566mm)
- \*SW: 19.2"(487mm)
- \*SD: 17.5"(443mm)

\* All measurements taken with the BIFMA chair measuring device.

### Features

- Back: High-strength polymer back with flexing perforations and an optional upholstered foam pad.
- Seat: High-strength polymer seat with an optional upholstery pad.
- Upholstered seat features 1"(25.4mm) foam pad.
- Upholstered back features 0.5"(12.7mm) foam pad.
- Frame: Available painted or trivalent chrome.
- Casters: Hard (black), soft (black) or two-tone (fog and gray).
- Glides: Plastic or felt.
- Stacks 5-high on the floor and 8-high non-upholstered or 6-high upholstered on a cart with glides and casters.
- COM yardage / COL square footage:  
Fully Upholstered: 1.5/17  
Upholstered seat: 0.75/9.5

### To Order, Specify:

1) Product number, including;

#### 1 Seat or Seat Pad Option:

- 1 Leather
- 2 Fabric
- 3 Faux Leather
- 4 Polymer

#### 2 Back or Back Pad Option:

- 1 Leather
- 2 Fabric
- 3 Faux Leather
- 4 Polymer

#### 3 Glide or Caster Option:

- H Plastic Glide
- K Felt Glide
- 1 Hard Casters, add **\$65.91** list
- 2 Soft Casters, add **\$125.93** list
- T Two-Tone Casters, add **\$65.91** list

- 2) Fabric surface and color (seat).
- 3) Fabric surface and color (back).
- 4) Shell color – required for upholstered and non-upholstered.
- 5) Add glide and plastic component trim color.
- 6) Frame trim color.  
Trivalent Chrome (KR-V) add **\$283.73** list.

Number ① ② ③	Price	Fabric Grade		C	D	E	F	G	H	Leather Grade A	Leather Grade B
		A	B								
<b>Without Optional Upholstered Pad</b>											
SCS- 4 4 -0	\$413.70	N/A	N/A	N/A	N/A	N/A	N/A	N/A	N/A	N/A	N/A
<b>With Upholstered Seat Pad</b>											
SCS- 4 -0 E	N/A	\$536.27	\$589.37	\$646.12	\$671.74	\$695.50	\$ 743.14	\$ 788.88	\$ 909.72	\$ 781.56	\$1000.94
<b>With Upholstered Seat and Back Pads</b>											
SCS- -0 E	N/A	\$650.54	\$756.74	\$870.24	\$921.48	\$969.00	\$1064.28	\$1155.76	\$1397.44	\$1141.12	\$1579.88

The following options require modification of the product number.

Stain repellent

To specify, add **P** to end of the product number (add **\$56.75** list)

**NOTE:** Stain repellent is available on SCS-22 and SCS-24 models only.

For available fabrics, refer to [surfaces.haworth.com](http://surfaces.haworth.com).

# Very

## Side Chair with Tablet Arm – Perforated Back

### Side Chair With Tablet Arm

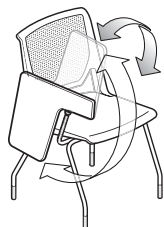

SCS-44-RH

#### Dimensions

- \*SH: 18.2"(461mm)
- H: 33.9"(861mm)
- D: 22"(559mm)
- W: 23.5"(597mm)
- \*SW: 19.2"(487mm)
- \*SD: 17.5"(443mm)

\* All measurements taken with the BIFMA chair measuring device.

#### Features

- Back: High-strength polymer back with flexing perforations and an optional upholstery pad.
- Seat: High-strength polymer with an optional upholstery pad.
- Upholstered seat features 1"(25.4mm) foam pad.
- Upholstered back features 0.5"(12.7mm) foam pad.
- Arm cap: Black.
- Tablet assembly painted black.
- Clearance from tablet to chair back 12.5"(318mm)-15.5"(394mm) angled.
- Flips up and fold away laminate tablet with matching laminate underside.
- Left or right-hand configurations.
- Tablet arm size: 15"(381mm)W x 9.8"(249mm)D (Sized to accommodate laptops).
- Base: available painted or optional trivalent chrome.
- Glides or Casters.
- Standard with hard casters, black or two-tone.
- Optional black soft casters.
- COM yardage / COL square footage:  
Fully Upholstered: 1.5/13  
Upholstered seat: .75/7.25

#### To Order, Specify:

1) Product number.

#### 1 Seat or Seat Pad Option:

- 1 Leather
- 2 Fabric
- 3 Faux Leather
- 4 Polymer

#### 2 Back or Back Pad Option:

- 1 Leather
- 2 Fabric
- 3 Faux Leather
- 4 Perforated Polymer

#### 3 Tablet Option:

- R Right-Hand Tablet Arm
- L Left-Hand Tablet Arm

#### 4 Glide or Caster Option:

- H Plastic Glide
- K Felt Glide
- 1 Hard Casters, add **\$65.91** list
- 2 Soft Casters, add **\$125.93** list
- T Two-Tone Casters, add **\$65.91** list

- 2) Fabric surface and color (seat).
- 3) Fabric surface and color (back).
- 4) Shell color - required for upholstered and non-upholstered.
- 5) Trim for arm caps (if specified) and glides.
- 6) Frame trim color.  
Trivalent Chrome (KR-V) add **\$283.73** list.
- 7) Laminate for tablet (if specified).

Description	Number				Price	Fabric Grade								Leather Grade A	Leather Grade B
	1	2	3	4		A	B	C	D	E	F	G	H		
<b>Without Optional Upholstered Pad</b>															
SCS- 4 4 -					\$734.03	N/A	N/A	N/A	N/A	N/A	N/A	N/A	N/A	N/A	
<b>With Upholstered Seat Pad</b>															
SCS- 4 -				E	N/A	\$856.60	\$ 909.70	\$ 966.45	\$ 992.07	\$1015.83	\$1063.47	\$1109.21	\$1230.05	\$1101.89	\$1321.27
<b>With Upholstered Seat and Back Pads</b>															
SCS- -				E	N/A	\$970.87	\$1077.07	\$1190.57	\$1241.81	\$1289.34	\$1336.98	\$1476.09	\$1717.78	\$1461.45	\$1900.21

The following options require modification of the product number.

Stain repellent

To specify, add **P** to end of the product number; **Example:** SCS-22-RHEP (add **\$56.75** list)

# Very

## Side Chair with Storage Rack – Perforated Back



SCK-44-3H

### Dimensions

- \*SH: 18.2"(461mm)
- H: 33.9"(861mm)
- D: 22"(559mm)
- W: 23.5"(597mm)
- \*SW: 19.2"(487mm)
- \*SD: 17.5"(443mm)
- \*AH: 8.9"(226mm)
- Between Arms:  
19.6"(498mm)

\* All measurements taken with the BIFMA chair measuring device.

### Features

- Back: High-strength polymer back with flexing perforations and an optional upholstery pad.
- Seat: Injection-molded with an optional upholstery pad.
- Upholstered seat features 1"(25.4mm) foam pad.
- Upholstered back features 0.5"(12.7mm) foam pad.
- Storage rack ships unassembled (chrome only).
- Arms: Black or Fog arm caps when no tablet is specified.
- Optional Tablet arm:
  - Tablet assembly painted black.
  - Flips up and fold away laminate tablet with matching laminate underside.
  - Left or right-hand configurations.
  - Tablet arm size: 15"(381mm)W x 9.8"(249mm)D (Sized to accommodate laptops).
- Base: available painted or optional trivalent chrome.
- Glides or Casters: Standard with hard casters, black or two-tone.
- Optional black soft casters.
- COM yardage / COL square footage:
  - Fully Upholstered: 1.5/13
  - Upholstered seat: .75/7.25

### To Order, Specify:

1) Product number.

#### 1 Seat or Seat Pad Option:

- 1 Leather
- 2 Fabric
- 3 Faux Leather
- 4 Polymer

#### 2 Back or Back Pad Option:

- 1 Leather
- 2 Fabric
- 3 Faux Leather
- 4 Perforated Polymer

#### 3 Arm Option:

- R Right-Hand Tablet Arm, add **\$305.08** list
- L Left-Hand Tablet Arm, add **\$305.08** list
- 0 No Arms
- 3 Fixed Arm, Hard Caps, add **\$95.19** list

#### 4 Glide or Caster Option:

- H Plastic Glide
- K Felt Glide
- 1 Hard Casters, add **\$65.91** list
- 2 Soft Casters, add **\$125.93** list
- T Two-Tone Casters, add **\$65.91** list

2) Fabric surface and color (seat).

3) Fabric surface and color (back).

4) Shell color - required for upholstered and non-upholstered.

5) Trim for arm caps (if specified) and glides.

6) Frame trim color.

Trivalent Chrome (KR-V) add **\$283.73** list.

7) Laminate for tablet (if specified).

Description	Number				Price	Fabric Grade					Leather Grade A	Leather Grade B			
	1	2	3	4		A	B	C	D	E			F	G	H
<b>Without Optional Upholstered Pad</b>															
SCK- 4 - 4 - ■ ■					\$532.68	N/A	N/A	N/A	N/A	N/A	N/A	N/A	N/A		
<b>With Upholstered Seat Pad</b>															
SCK- ■ 4 - ■ ■ E					N/A	\$655.25	\$708.35	\$765.10	\$ 790.72	\$ 814.48	\$ 862.12	\$ 907.86	\$1028.70	\$ 900.54	\$1119.92
<b>With Upholstered Seat and Back Pads</b>															
SCK- ■ ■ - ■ ■ E					N/A	\$769.52	\$875.72	\$989.22	\$1040.46	\$1087.98	\$1183.26	\$1274.74	\$1516.42	\$1260.10	\$1698.86

The following options require modification of the product number.

Stain repellent

To specify, add **P** to end of the product number; **Example:** SCK-22-RHEP (add **\$56.75** list)

# Very

## Bar Height Side Stool – Perforated Back

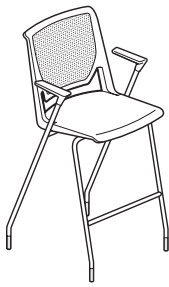

SCL-44-3H

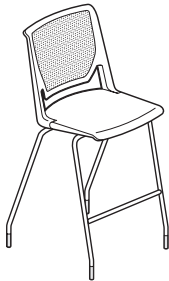

SCL-44-0H

### Dimensions

- SH: 29.75"(756mm)
- H: 46.25"(1175mm)
- D: 23"(587mm)
- W: 23.75"(604mm)
- SW: 18.75"(477mm)
- SD: 17.2"(434mm)
- AH: 8.9"(226mm)
- Between Arms: 19.6"(498mm)

### Features

- Back options: High-strength polymer with flexing perforations and an optional upholstery pad.
- Seat: Injection-molded high-strength polymer seat with an optional upholstery pad.
- Upholstered seat features 1"(25.4mm) foam pad.
- Upholstered back features 0.5"(12.7mm) foam pad.
- Arms: Black or Fog high-strength polymer arm caps.
- Base: available painted or optional trivalent chrome.
- Standard with glides.
- Stacks 5 high on the floor.
- COM yardage / COL square footage:  
Fully Upholstered: 1.5/13  
Upholstered seat: .75/7.25

### To Order, Specify:

1) Product number.

#### 1 Seat or Seat Pad Option:

- 1 Leather
- 2 Fabric
- 3 Faux Leather
- 4 Polymer

#### 2 Back or Back Pad Option:

- 1 Leather
- 2 Fabric
- 3 Faux Leather
- 4 Perforated Polymer

#### 3 Glide Option:

- H Plastic Glide
- K Felt Glide

- 2) Fabric surface and color (seat).
  - 3) Fabric surface and color (back).
  - 4) Shell color - required for upholstered and non-upholstered.
  - 5) Trim for arm caps (if specified) and glides.
  - 6) Frame trim color.
- Trivalent Chrome (KR-V) add **\$283.73** list.

Description	Number ①②③	Price	Fabric Grade		C	D	E	F	G	H	Leather Grade A	Leather Grade B
			A	B								
<b>Without Optional Upholstered Pad</b>												
With Arms	SCL- 44 -3	\$1056.22	N/A	N/A	N/A	N/A	N/A	N/A	N/A	N/A	N/A	N/A
Without Arms	SCL- 44 -0	961.03	N/A	N/A	N/A	N/A	N/A	N/A	N/A	N/A	N/A	N/A
<b>With Upholstered Seat Pad</b>												
With Arms	SCL- 4 -3 E	N/A	\$1178.79	\$1231.89	\$1288.64	\$1314.26	\$1338.02	\$1385.66	\$1431.40	\$1552.24	\$1424.08	\$1643.46
Without Arms	SCL- 4 -0 E	N/A	1083.60	1136.70	1193.45	1219.07	1242.83	1290.47	1336.21	1457.05	1328.89	1548.27
<b>With Upholstered Seat and Back Pads</b>												
With Arms	SCL- 4 -3 E	N/A	\$1293.06	\$1399.26	\$1512.76	\$1564.00	\$1611.52	\$1706.80	\$1798.28	\$2039.96	\$1783.64	\$2222.40
Without Arms	SCL- 4 -0 E	N/A	1197.87	1304.07	1417.57	1468.81	1516.33	1611.61	1703.09	1944.77	1688.45	2127.21

The following options require modification of the product number.

Stain repellent

To specify, add **P** to end of the product number; **Example:** SCL-22-3HEP (add **\$56.75** list)

**NOTE:** Stain repellent is available on SCL-22 or SCL-24 models only.

For available fabrics, refer to [surfaces.haworth.com](http://surfaces.haworth.com).

# Very

## Counter Height Side Stool – Perforated Back

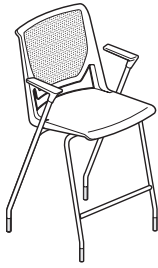

SCLC-44-3H

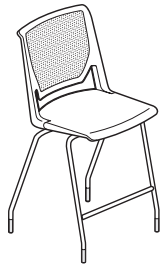

SCLC-44-0H

### Dimensions

SH: 25.75"(654mm)  
 H: 42.25"(1073mm)  
 D: 21.7"(551mm)  
 W: 23.75"(604mm)  
 SW: 18.75"(477mm)  
 SD: 17.2"(434mm)  
 AH: 8.9"(226mm)  
 Between Arms:  
 19.6"(498mm)

### Features

- Back options: High-strength polymer with flexing perforations and an optional upholstery pad.
- Seat: Injection-molded high-strength polymer seat with an optional upholstery pad.
- Upholstered seat features 1"(25.4mm) foam pad.
- Upholstered back features 0.5"(12.7mm) foam pad.
- Arms: Black or Fog high-strength polymer arm caps.
- Base: available painted or optional trivalent chrome.
- Standard with glides.
- Stacks 5 high on the floor.
- COM yardage / COL square footage:  
 Fully Upholstered: 1.5/13  
 Upholstered seat: .75/7.25

### To Order, Specify:

1) Product number.

#### 1 Seat or Seat Pad Option:

- 1 Leather
- 2 Fabric
- 3 Faux Leather
- 4 Polymer

#### 2 Back or Back Pad Option:

- 1 Leather
- 2 Fabric
- 3 Faux Leather
- 4 Perforated Polymer

#### 3 Glide Option:

- H Plastic Glide
- K Felt Glide

2) Fabric surface and color (seat).

3) Fabric surface and color (back).

4) Shell color - required for upholstered and non-upholstered.

5) Trim for arm caps (if specified) and glides.

6) Frame trim color.

Trivalent Chrome (KR-V) add **\$283.73** list.

Description	Number			Price	Fabric Grade								Leather Grade A	Leather Grade B
	1	2	3		A	B	C	D	E	F	G	H		
<b>Without Optional Upholstered Pad</b>														
With Arms	SCLC-	44	-3	\$1056.22	N/A	N/A	N/A	N/A	N/A	N/A	N/A	N/A	N/A	N/A
Without Arms	SCLC-	44	-0	961.03	N/A	N/A	N/A	N/A	N/A	N/A	N/A	N/A	N/A	N/A
<b>With Upholstered Seat Pad</b>														
With Arms	SCLC-	4	-3	N/A	\$1178.79	\$1231.89	\$1288.64	\$1314.26	\$1338.02	\$1385.66	\$1431.40	\$1552.24	\$1424.08	\$1643.46
Without Arms	SCLC-	4	-0	N/A	1083.60	1136.70	1193.45	1219.07	1242.83	1290.47	1336.21	1457.05	1328.89	1548.27
<b>With Upholstered Seat and Back Pads</b>														
With Arms	SCLC-		-3	N/A	\$1293.06	\$1399.26	\$1512.76	\$1564.00	\$1611.52	\$1706.80	\$1798.28	\$2039.96	\$1783.64	\$2222.40
Without Arms	SCLC-		-0	N/A	1197.87	1304.07	1417.57	1468.81	1516.33	1611.61	1703.09	1944.77	1688.45	2127.21

The following options require modification of the product number.

Stain repellent

To specify, add **P** to end of the product number; **Example:** SCLC-22-3HEP (add **\$56.75** list)

**NOTE:** Stain repellent is available on SCLC-22 or SCLC-24 models only.

For available fabrics, refer to [surfaces.haworth.com](https://surfaces.haworth.com).

# Very

## Seminar Chair – Perforated Back

**With Arms**

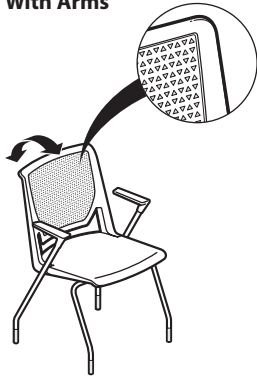

SCM-44-3H

**Dimensions**

- \*SH: 18.2”(461mm)
- H: 33.9”(861mm)
- D: 22”(559mm)
- W: 23.5”(597mm)
- \*SW: 19.2”(487mm)
- \*SD: 17.5”(443mm)
- \*AH: 8.9”(226mm)
- Between Arms:  
19.6”(498mm)

\* All measurements taken with the BIFMA chair measuring device.

**Features**

- Back: High-strength polymer back with flexing perforations and an optional upholstered foam pad.
- Seat: High-strength polymer seat with an optional upholstery pad.
- Weight assisted recline mechanism.
- Upholstered seat features 1”(25.4mm) foam pad.
- Upholstered back features 0.5”(12.7mm) foam pad.
- Arms: Black or Fog glass-filled polypropylene arm caps.
- Frame: Available painted or trivalent chrome.
- Casters: Hard (black), soft (black) or two-tone (fog and gray).
- Glides: Plastic or felt.
- Stacks 5-high on the floor and 8-high non-upholstered and 6-high upholstered on a cart with glides and casters.
- COM yardage / COL square footage:  
Fully Upholstered: 1.5/17  
Upholstered seat: 0.75/9.5

**To Order, Specify:**

1) Product number, including;

**1 Seat or Seat Pad Option:**

- 1 Leather
- 2 Fabric
- 3 Faux Leather
- 4 Polymer

**2 Back or Back Pad Option:**

- 1 Leather
- 2 Fabric
- 3 Faux Leather
- 4 Polymer

**3 Glide or Caster Option:**

- H Plastic Glide
- K Felt Glide
- 1 Hard Casters, add **\$84.20** list
- 2 Soft Casters, add **\$143.62** list
- T Two-Tone Casters, add **\$84.20** list

- 2) Fabric surface and color (seat).
- 3) Fabric surface and color (back).
- 4) Shell color – required for upholstered and non-upholstered.
- 5) Trim for arm caps, glides, and plastic components.
- 6) Frame trim color.  
Trivalent Chrome (KR-V) add **\$283.73** list.

Number 1 2 3	Price	Fabric Grade		C	D	E	F	G	H	Leather Grade A	Leather Grade B
		A	B								
<b>Without Optional Upholstered Pad</b>											
SCM- 4 4 -3	\$876.84	N/A	N/A	N/A	N/A	N/A	N/A	N/A	N/A	N/A	N/A
<b>With Upholstered Seat Pad</b>											
SCM- 4 -3 E	N/A	\$1032.24	\$1085.34	\$1142.09	\$1167.71	\$1191.47	\$1239.11	\$1284.85	\$1405.69	\$1277.53	\$1496.91
<b>With Upholstered Seat and Back Pads</b>											
SCM- -3 E	N/A	\$1151.49	\$1257.69	\$1371.19	\$1422.43	\$1469.95	\$1565.23	\$1656.71	\$1898.39	\$1642.07	\$2080.83

The following options require modification of the product number.

Stain repellent

To specify, add **P** to end of the product number (add **\$56.75** list)

**NOTE:** Stain repellent is available on SCM-22 and SCM-24 models only.

For available fabrics, refer to [surfaces.haworth.com](http://surfaces.haworth.com).

# Very

## Seminar Chair – Perforated Back

### Without Arms

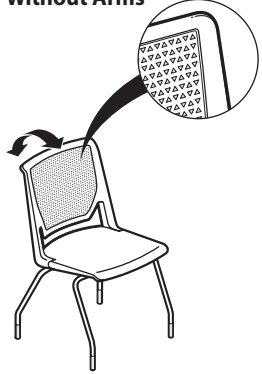

SCM-44-0H

### Dimensions

- \*SH: 18.2”(461mm)
- H: 33.9”(861mm)
- D: 22”(559mm)
- W: 22.3”(566mm)
- \*SW: 19.2”(487mm)
- \*SD: 17.5”(443mm)

\* All measurements taken with the BIFMA chair measuring device.

### Features

- Back: High-strength polymer back with flexing perforations and an optional upholstered foam pad.
- Seat: High-strength polymer seat with an optional upholstery pad.
- Weight assisted recline mechanism.
- Upholstered seat features 1”(25.4mm) foam pad.
- Upholstered back features 0.5”(12.7mm) foam pad.
- Arms: Black or Fog glass-filled polypropylene arm caps.
- Frame: Available painted or trivalent chrome.
- Casters: Hard (black), soft (black) or two-tone (fog and gray).
- Glides: Plastic or felt.
- Stacks 5-high on the floor and 8-high non-upholstered and 6-high upholstered on a cart with glides and casters.
- COM yardage / COL square footage:  
Fully Upholstered: 1.5/17  
Upholstered seat: 0.75/9.5

### To Order, Specify:

1) Product number, including;

#### 1 Seat or Seat Pad Option:

- 1 Leather
- 2 Fabric
- 3 Faux Leather
- 4 Polymer

#### 2 Back or Back Pad Option:

- 1 Leather
- 2 Fabric
- 3 Faux Leather
- 4 Polymer

#### 3 Glide or Caster Option:

- H Plastic Glide
- K Felt Glide
- 1 Hard Casters, add **\$84.20** list
- 2 Soft Casters, add **\$143.62** list
- T Two-Tone Casters, add **\$84.20** list

- 2) Fabric surface and color (seat).
  - 3) Fabric surface and color (back).
  - 4) Shell color – required for upholstered and non-upholstered.
  - 5) Glide and plastic component trim color.
  - 6) Frame trim color.
- Trivalent Chrome (KR-V) add **\$283.73** list.

Number ① ② ③	Price	Fabric Grade										Leather Grade A	Leather Grade B
		A	B	C	D	E	F	G	H				
<b>Without Optional Upholstered Pad</b>													
SCM- 4 4 -0	\$1101.99	N/A	N/A	N/A	N/A	N/A	N/A	N/A	N/A	N/A	N/A	N/A	N/A
<b>With Upholstered Seat Pad</b>													
SCM- 4 -0 E	N/A	\$1257.39	\$1310.48	\$1367.24	\$1392.86	\$1416.62	\$1464.26	\$1509.99	\$1630.84	\$1502.68	\$1722.05		
<b>With Upholstered Seat and Back Pads</b>													
SCM- 4 -0 E	N/A	\$1376.63	\$1482.83	\$1596.34	\$1647.58	\$1695.10	\$1790.38	\$1881.85	\$2123.54	\$1867.22	\$2305.97		

The following options require modification of the product number.

Stain repellent

To specify, add **P** to end of the product number (add **\$56.75** list)

**NOTE:** Stain repellent is available on SCM-22 and SCM-24 models only.

For available fabrics, refer to [surfaces.haworth.com](http://surfaces.haworth.com).



**Seminar With Storage Rack**

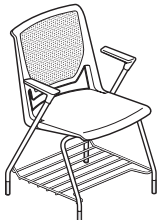

SCB-44-3H

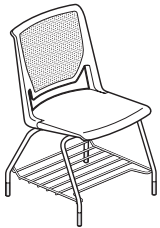

SCB-44-0H

**Dimensions**

- \*SH: 18.2”(461mm)
- H: 33.9”(861mm)
- D: 22”(559mm)
- W: 23.5”(597mm)
- \*SW: 19.2”(487mm)
- \*SD: 17.5”(443mm)
- \*AH: 8.9”(226mm)
- Between Arms: 19.6”(498mm)

\* All measurements taken with the BIFMA chair measuring device.

**Features**

- Back: High-strength polymer back with flexing perforations and an optional upholstery pad.
- Seat: High-strength polymer seat with an optional upholstery pad.
- Weight assisted recline mechanism.
- Upholstered seat features 1”(25.4mm) foam pad.
- Upholstered back features 0.5”(12.7mm) foam pad.
- Arms: Black or Fog arm caps.
- Storage rack available in Chrome only.
- Tablet assembly painted black.
- Flips up and fold away laminate tablet with matching laminate underside.
- Left or right-hand configurations.
- Tablet arm size: 15”(381mm)W x 9.8”(249mm)D (Sized to accommodate laptops).
- Ships with chair, unassembled.
- Base: available painted or optional trivalent chrome.
- Glides or Casters: Standard with hard casters, black or two-tone.
- Optional black soft casters.
- COM yardage / COL square footage:  
Fully Upholstered: 1.5/13  
Upholstered seat: .75/7.25

**To Order, Specify:**

1) Product number.

**1 Seat or Seat Pad Option:**

- 1** Leather
- 2** Fabric
- 3** Faux Leather
- 4** Polymer Back or Back Pad

**2 Back or Back Pad Option:**

- 1** Leather
- 2** Fabric Faux Leather
- 4** Perforated Polymer

**3 Arm Option:**

- R** Right-Hand Tablet Arm, add **\$305.08** list
- L** Left-Hand Tablet Arm, add **\$305.08** list
- 0** No Arms
- 3** Fixed Arm, Hard Caps, add **\$90.66** list

**4 Glide or Caster Option:**

- H** Plastic Glide
- K** Felt Glide
- 1** Hard Casters, add **\$84.20** list
- 2** Soft Casters, add **\$143.62** list
- T** Two-Tone Casters, add **\$84.20** list

- 2) Fabric surface and color (seat).
  - 3) Fabric surface and color (back).
  - 4) Shell color - required for upholstered and non-upholstered.
  - 5) Trim for arm caps (if specified) and glides.
  - 6) Frame trim color.
- Trivalent Chrome (KR-V) add **\$283.73** list.

Description	Number				Price	Fabric Grade								Leather Grade A	Leather Grade B
	1	2	3	4		A	B	C	D	E	F	G	H		
<b>Without Optional Upholstered Pad</b>															
SCB- 4 4 -					\$900.63	N/A	N/A	N/A	N/A	N/A	N/A	N/A	N/A	N/A	
<b>With Upholstered Seat Pad</b>															
SCB- 4 -				E	N/A	\$1056.03	\$1109.13	\$1165.88	\$1191.50	\$1215.26	\$1262.90	\$1308.64	\$1429.48	\$1301.32	\$1520.69
<b>With Upholstered Seat and Back Pads</b>															
SCB- - -				E	N/A	\$1175.28	\$1281.47	\$1394.98	\$1446.22	\$1493.74	\$1589.02	\$1680.49	\$1922.18	\$1665.86	\$2104.61

The following options require modification of the product number.

Stain repellent

To specify, add **P** to end of the product number; **Example:** SCB-22-RHEP (add **\$56.75** list)

This page intentionally blank

# Very Perforated Conference Chair and Conference Stool

General Specifications

**Features and Options  
(Conference Chair and Conference Stool)**

- Back: High-strength polymer back with flexing perforations and an optional upholstered foam pad
- Seat: High-strength polymer seat with an optional upholstered polyurethane foam pad
- Five-star base with casters: hard (black), soft (black) or two-tone (fog and gray)
- Base: painted aluminum, polished aluminum or plastic (fog or black)
- Frame finishes include: painted or polished aluminum
- Weight assisted recline mechanism
- Pneumatic height adjustment
- Fog or black trim arm caps
- Arm or armless version available
- Adjustable footring in brushed aluminum (stool only)

**General Guidelines for  
Product Specification**

	S	C	C - 2	2 - 1	1	E	3A-18	3A-18	TR-FA	TR-F	TR-LE
<b>Conference</b>											
Product Type											
(S) Seating											
Product Line											
(C) Very											
Model											
(C) Conference											
(F) Stool											
Seat Upholstery											
(1) Leather											
(2) Fabric											
(3) Faux Leather											
(4) Polymer											
Back Upholstery											
(1) Leather											
(2) Fabric											
(3) Faux Leather											
(4) Polymer											
Arm/Caps											
(0) No Arms											
(1) Fixed Arms, Soft Caps											
Base/Caster											
(1) Aluminum Standard Base, Hard Caster											
(2) Aluminum Standard Base, Soft Caster											
(3) Aluminum Low Base, Hard Caster											
(4) Aluminum Low Base, Soft Caster											
(5) Plastic Standard Base, Hard Caster											
(6) Plastic Standard Base, Soft Caster											
(7) Plastic Low Base, Hard Caster											
(8) Plastic Low Base, Soft Caster											
(N) Plastic Low Base, Two-Tone Casters											
(P) Plastic Standard Base, Two-Tone Casters											
(R) Aluminum Low Base, Two-Tone Casters											
(T) Aluminum Standard Base, Two-Tone Casters											
Enhanced Upholstery											
Seat Upholstery											
Tellure											
Back Upholstery											
Tellure											
Shell Color											
Tomato											
Trim Color											
Black											
Frame Trim Color											
Metallic Silver											

# Very

## Conference Chair - Perforated Back

### With Arms



SCC-44-11

### Dimensions

- \*SH: 15.5"(394mm)-20.5"(521mm)
- H: 36.9"(937mm)
- D: 26.7"(678mm)
- W: 25"(635mm)
- \*SW: 19.2"(487mm)
- \*SD: 17.5"(443mm)
- \*AH: 8.7"(220mm)
- Between Arms: 20.8"(528mm)

### Low position base:

- \*SH: 14.4"(366mm)-19.4"(493mm)

\* All measurements taken with the BIFMA chair measuring device.

### Features

- Back: High-strength polymer with flexing perforations and an optional upholstered foam pad.
- Seat: High-strength polymer with an optional upholstered foam pad.
- Upholstered seat features 1"(25.4mm) foam pad.
- Upholstered back features 0.5"(12.7mm) foam pad.
- Arms: Black or Fog glass-filled polypropylene hard arm caps.
- Base: Standard five-star all aluminum or all plastic base.
- 5"(127mm) height adjustment.
- Weight assisted recline mechanism.
- Casters: Hard (black), soft (black) or two-tone (fog and gray).
- Back tilts backward 14° from the upright position. Additional recline achieved in flexible back.
- Painted or optional polished aluminum.
- COM yardage / COL square footage:  
Fully Upholstered: 1.5/17  
Upholstered seat: 0.75/9.5

### To Order, Specify:

1) Product number, including;

#### 1 Seat or Seat Pad Option:

- 1 Leather
- 2 Fabric
- 3 Faux Leather
- 4 Polymer

#### 2 Back or Back Pad Option:

- 1 Leather
- 2 Fabric
- 3 Faux Leather
- 4 Polymer

### To Order, Specify (cont'd):

#### 3 Base/Caster Option:

##### Aluminum Base

- 1 Aluminum Std. Base, Hard Caster
- 2 Aluminum Std. Base, Soft Caster, add **\$62.28** list
- 3 Aluminum Low Base, Hard Caster
- 4 Aluminum Low Base, Soft Caster, add **\$62.28** list

##### Plastic Base

- 5 Plastic Std. Base, Hard Caster
- 6 Plastic Std. Base, Soft Caster, add **\$62.28** list
- 7 Plastic Low Base, Hard Caster
- 8 Plastic Low Base, Soft Caster, add **\$62.28** list

##### Two-Tone Casters

- N Plastic Low Base, Two-Tone Casters
- P Plastic Std. Base, Two-Tone Casters
- R Aluminum Low Base, Two-Tone Casters
- T Aluminum Std. Base, Two-Tone Casters

- 2) Fabric surface and color (seat).
  - 3) Fabric surface and color (back).
  - 4) Shell color – required for upholstered and non-upholstered.
  - 5) Trim for arm caps, plastic components and base (plastic base only).
  - 6) Trim color for aluminum components (aluminum base, control housing, and frame).
- Polished Aluminum (PM-P) add **\$283.73** list.

Number 1 2 3	Price	Fabric Grade		C	D	E	F	G	H	Leather Grade A	Leather Grade B
		A	B								
<b>Aluminum Base Without Optional Upholstered Pad</b>											
SCC- 4 4 -1	\$1416.84	N/A	N/A	N/A	N/A	N/A	N/A	N/A	N/A	N/A	N/A
<b>Aluminum Base With Upholstered Seat Pad</b>											
SCC- 4 4 -1 E	N/A	\$1605.92	\$1659.02	\$1715.77	\$1741.39	\$1765.15	\$1812.79	\$1858.53	\$1979.37	\$1851.21	\$2070.59
<b>Aluminum Base With Upholstered Seat and Back Pads</b>											
SCC- 4 4 -1 E	N/A	\$1738.85	\$1845.05	\$1958.55	\$2009.79	\$2057.31	\$2152.59	\$2244.07	\$2485.75	\$2229.43	\$2668.19
<b>Plastic Base Without Optional Upholstered Pad</b>											
SCC- 4 4 -1	\$1228.31	N/A	N/A	N/A	N/A	N/A	N/A	N/A	N/A	N/A	N/A
<b>Plastic Base With Upholstered Seat Pad</b>											
SCC- 4 4 -1 E	N/A	\$1417.38	\$1470.48	\$1527.23	\$1552.85	\$1576.61	\$1624.25	\$1669.99	\$1790.83	\$1662.67	\$1882.05
<b>Plastic Base With Upholstered Seat and Back Pads</b>											
SCC- 4 4 -1 E	N/A	\$1550.31	\$1656.51	\$1770.01	\$1821.25	\$1868.77	\$1964.05	\$2055.53	\$2297.21	\$2040.89	\$2479.65

The following options require modification of the product number.

Stain repellent

To specify, add **P** to end of the product number (add **\$56.75** list)

**NOTE:** Stain repellent is available on SCC-22 and SCC-24 models only.

For available fabrics, refer to [surfaces.haworth.com](http://surfaces.haworth.com).

# Very

## Conference Chair - Perforated Back

**Without Arms**

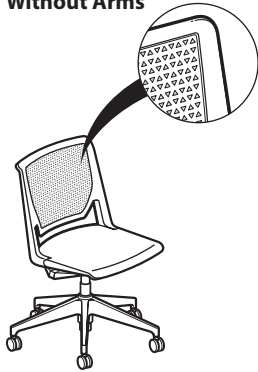

SCC-44-01

**Dimensions**

- \*SH: 15.5"(394mm)-20.5"(521mm)
- H: 36.9"(937mm)
- D: 26.7"(678mm)
- W: 21.8"(554mm)
- \*SW: 19.2"(487mm)
- \*SD: 17.5"(443mm)

- Low position base:
- \*SH: 14.4"(366mm)-19.4"(493mm)

\* All measurements taken with the BIFMA chair measuring device.

**Features**

- Back: High-strength polymer with flexing perforations and an optional upholstered foam pad.
- Seat: High-strength polymer with an optional upholstered foam pad.
- Upholstered seat features 1"(25.4mm) foam pad.
- Upholstered back features 0.5"(12.7mm) foam pad.
- Base: Standard five-star all aluminum or all plastic base.
- 5"(127mm) height adjustment.
- Weight assisted recline mechanism.
- Casters: Hard (black), soft (black) or two-tone (fog and gray).
- Back tilts backward 14° from the upright position. Additional recline achieved in flexible back.
- Painted or optional polished aluminum.
- COM yardage / COL square footage:  
Fully Upholstered: 1.5/17  
Upholstered seat: 0.75/9.5

**To Order, Specify:**

1) Product number, including;

**1 Seat or Seat Pad Option:**

- 1 Leather
- 2 Fabric
- 3 Faux Leather
- 4 Polymer

**2 Back or Back Pad Option:**

- 1 Leather
- 2 Fabric
- 3 Faux Leather
- 4 Polymer

**To Order, Specify (cont'd):**

**3 Base/Caster Option:**

**Aluminum Base**

- 1 Aluminum Std. Base, Hard Caster
- 2 Aluminum Std. Base, Soft Caster, add **\$62.28** list
- 3 Aluminum Low Base, Hard Caster
- 4 Aluminum Low Base, Soft Caster, add **\$62.28** list

**Plastic Base**

- 5 Plastic Std. Base, Hard Caster
- 6 Plastic Std. Base, Soft Caster, add **\$62.28** list
- 7 Plastic Low Base, Hard Caster
- 8 Plastic Low Base, Soft Caster, add **\$62.28** list

**Two-Tone Casters**

- N Plastic Low Base, Two-Tone Casters
- P Plastic Std. Base, Two-Tone Casters
- R Aluminum Low Base, Two-Tone Casters
- T Aluminum Std. Base, Two-Tone Casters

- 2) Fabric surface and color (seat).
  - 3) Fabric surface and color (back).
  - 4) Shell color – required for upholstered and non-upholstered.
  - 5) Trim for plastic components and base (plastic base only).
  - 6) Trim color for aluminum components (aluminum base, control housing, and frame).
- Polished Aluminum (PM-P) add **\$283.73** list.

Number 1 2 3	Price	Fabric Grade		C	D	E	F	G	H	Leather Grade A	Leather Grade B
		A	B								
<b>Aluminum Base Without Optional Upholstered Pad</b>											
SCC- 4 4 -0	\$1303.34	N/A	N/A	N/A	N/A	N/A	N/A	N/A	N/A	N/A	N/A
<b>Aluminum Base With Upholstered Seat Pad</b>											
SCC- 4 4 -0 E	N/A	\$1492.41	\$1545.51	\$1602.26	\$1627.88	\$1651.64	\$1699.28	\$1745.02	\$1865.86	\$1737.70	\$1957.08
<b>Aluminum Base With Upholstered Seat and Back Pads</b>											
SCC- 4 4 -0 E	N/A	\$1625.34	\$1731.54	\$1845.04	\$1896.28	\$1943.80	\$2039.08	\$2130.56	\$2372.24	\$2115.92	\$2554.68
<b>Plastic Base Without Optional Upholstered Pad</b>											
SCC- 4 4 -0	\$1114.80	N/A	N/A	N/A	N/A	N/A	N/A	N/A	N/A	N/A	N/A
<b>Plastic Base With Upholstered Seat Pad</b>											
SCC- 4 4 -0 E	N/A	\$1303.87	\$1356.97	\$1413.72	\$1439.34	\$1463.10	\$1510.74	\$1556.48	\$1677.32	\$1549.16	\$1768.54
<b>Plastic Base With Upholstered Seat and Back Pads</b>											
SCC- 4 4 -0 E	N/A	\$1436.80	\$1543.00	\$1656.50	\$1707.74	\$1755.26	\$1850.54	\$1942.02	\$2183.70	\$1927.38	\$2366.14

The following options require modification of the product number.

Stain repellent

To specify, add **P** to end of the product number (add **\$56.75** list)

**NOTE:** Stain repellent is available on SCC-22 and SCC-24 models only.

For available fabrics, refer to [surfaces.haworth.com](http://surfaces.haworth.com).

# Very

## Conference Stool – Perforated Back



SCF-44-11



SCF-44-01

### Dimensions

SH: 23"-32"  
(584mm-813mm)  
H: 44.4"-53.4"  
(1128mm-1356mm)  
D: 26.7"(678mm)  
W: 25"(635mm)  
SW: 18.75"(477mm)  
SD: 17.2"(434mm)  
AH: 8.7"(221mm)  
Between Arms:  
20.8"(528mm)

### Features

- Back: High-strength polymer back with flexing perforations and an optional upholstery pad.
- Seat: High-strength polymer seat with an optional upholstery pad.
- Weight assisted recline mechanism.
- Upholstered seat features 1"(25.4mm) foam pad.
- Upholstered back features 0.5"(12.7mm) foam pad.
- Arms: Black or Fog hard arm caps.
- Base: Standard five-star all aluminum or all plastic base.
- Footring: Brushed Aluminum finish.
- Adjustable footring: adjusts 4"(102mm) up and down.
- Casters: Standard with hard casters, black or two-tone.
- Optional black soft casters.
- COM yardage / COL square footage:  
Fully Upholstered: 1.5/13  
Upholstered seat: .75/7.25

### To Order, Specify:

1) Product number.

#### 1 Seat or Seat Pad Option:

- 1 Leather
- 2 Fabric
- 3 Faux Leather
- 4 Polymer

#### 2 Back or Back Pad Option:

- 1 Leather
- 2 Fabric
- 3 Faux Leather
- 4 Perforated Polymer

#### 3 Arm Option:

- 0 No Arms
- 1 Fixed Arm, Hard Caps, add \$227.02 list

#### 4 Base or Caster Option:

##### Aluminum Base

- 1 Aluminum Std. Base, Hard Casters
- 2 Aluminum Std. Base, Soft Casters, add \$62.28 list
- T Aluminum Std. Base, Two-Tone Casters

##### Plastic Base

- 5 Plastic Std. Base, Hard Casters
- 6 Plastic Std. Base, Soft Casters, add \$62.28 list
- P Plastic Std. Base, Two-Tone Casters

- 2) Fabric surface and color (seat).
- 3) Fabric surface and color (back).
- 4) Shell color - required for upholstered and non-upholstered.
- 5) Trim for arm caps (if specified). (base if plastic is specified above).
- 6) Frame trim color- Aluminum components (base if aluminum and arm uprights).

Description	Number				Price	Fabric Grade						Leather Grade A	Leather Grade B		
	1	2	3	4		A	B	C	D	E	F			G	H
<b>Aluminum Base Without Optional Upholstered Pad</b>															
SCF- 4 4 -					\$1839.70	N/A	N/A	N/A	N/A	N/A	N/A	N/A	N/A	N/A	
<b>Aluminum Base With Upholstered Seat Pad</b>															
SCF- 4 -				E	N/A	\$2028.77	\$2081.87	\$2138.62	\$2164.24	\$2188.00	\$2235.64	\$2281.38	\$2402.22	\$2274.06	\$2493.44
<b>Aluminum Base With Upholstered Seat and Back Pads</b>															
SCF- -				E	N/A	\$2161.70	\$2267.90	\$2381.40	\$2432.64	\$2480.16	\$2575.44	\$2666.92	\$2908.60	\$2652.28	\$3091.04
<b>Plastic Base Without Optional Upholstered Pad</b>															
SCF- 4 4 -					\$1651.16	N/A	N/A	N/A	N/A	N/A	N/A	N/A	N/A	N/A	
<b>Plastic Base With Upholstered Seat Pad</b>															
SCF- 4 -				E	N/A	\$1840.23	\$1893.33	\$1950.08	\$1975.70	\$1999.46	\$2047.10	\$2092.84	\$2213.68	\$2085.52	\$2304.90
<b>Plastic Base With Upholstered Seat and Back Pads</b>															
SCF- -				E	N/A	\$1973.16	\$2079.36	\$2192.86	\$2244.10	\$2291.62	\$2386.90	\$2478.38	\$2720.06	\$2463.74	\$2902.50

The following options require modification of the product number.

Stain repellent

To specify, add **P** to end of the product number; **Example:** SCF-22-01EP (add \$56.75 list)

**Very**  
Accessories

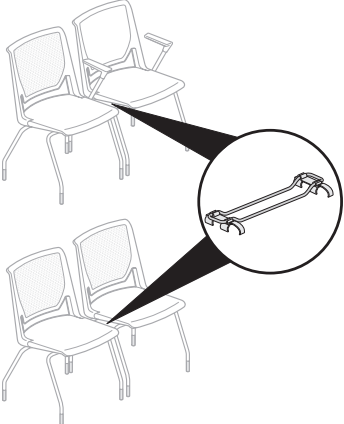
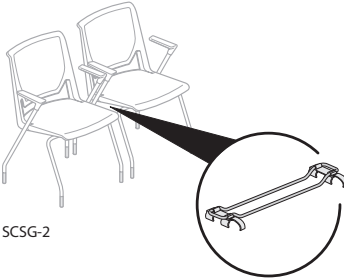
	Description	Number	Price
 <p>SCSG-1</p>	Arm to Armless and Armless to Armless	SCSG-1	\$23.79
	Arm to Arm	SCSG-2	24.96
 <p>SCSG-2</p>			

**Features**

- Field retrofittable.
- Recommended for use on chairs with glides only.
- Release for fire safety.

**To Order, Specify:**

- 1) Product number.  
(No finish specification required.)

	Description	Number	Price
 <p>SCT-1</p>	Wire Stacking Cart	SCT-1	\$721.27

**Features**

- For use with Very Wire Stacker seating.
- Cart only dimensions:  
28.5”(724mm) H x 23.88”(607mm) D x 20.25”(514mm) W

**To Order, Specify:**

- 1) Product number.  
(No color specification required.)

	Description	Number	Price
 <p>SCT-3 SCT-4</p>	Side/Seminar Chairs with Arms	SCT-3	\$604.10
	Side/Seminar Chairs without Arms	SCT-4	604.10

**Features**

- Permits stacking upholstered chairs 6-high and non-upholstered 8-high with glides and casters.
- Standard in black finish color only.
- **Cart Only Dimensions:**
  - SCT-3  
17.3”(439mm) H x 27”(689mm) D x 25.5”(648mm) W  
(wt: 10.09kg)
  - SCT-4  
17.6”(447mm) H x 30.4”(772mm) D x 25.5”(648mm) W  
(wt: 10.09kg)
- **Cart and Chair Maximum Dimensions:**
  - SCT-3  
69”(1753mm) H x 46”(1168mm) D x 24”(610mm) W
  - SCT-4  
57”(1448mm) H x 44”(1118mm) D x 24”(610mm) W
- Not for use with Side Stools.

**To Order, Specify:**

- 1) Product number.  
(No color specification required.)

This page intentionally blank



**General Guidelines for Product Specification**

	S	J	T	C	2	0	-	7	1	1	A	2	A	3A-18	XT-1	TR-F	TR-LE	
Product Type	_____	_____	_____	_____	_____	_____	_____	_____	_____	_____	_____	_____	_____	_____	_____	_____	_____	_____
(S) Seating	_____	_____	_____	_____	_____	_____	_____	_____	_____	_____	_____	_____	_____	_____	_____	_____	_____	_____
Product Line	_____	_____	_____	_____	_____	_____	_____	_____	_____	_____	_____	_____	_____	_____	_____	_____	_____	_____
(J) Soji	_____	_____	_____	_____	_____	_____	_____	_____	_____	_____	_____	_____	_____	_____	_____	_____	_____	_____
Model (Product Type)	_____	_____	_____	_____	_____	_____	_____	_____	_____	_____	_____	_____	_____	_____	_____	_____	_____	_____
(T) Task	_____	_____	_____	_____	_____	_____	_____	_____	_____	_____	_____	_____	_____	_____	_____	_____	_____	_____
Posture (only used for stool)	_____	_____	_____	_____	_____	_____	_____	_____	_____	_____	_____	_____	_____	_____	_____	_____	_____	_____
(C) Stool	_____	_____	_____	_____	_____	_____	_____	_____	_____	_____	_____	_____	_____	_____	_____	_____	_____	_____
Seat Upholstery	_____	_____	_____	_____	_____	_____	_____	_____	_____	_____	_____	_____	_____	_____	_____	_____	_____	_____
(1) Leather	_____	_____	_____	_____	_____	_____	_____	_____	_____	_____	_____	_____	_____	_____	_____	_____	_____	_____
(2) Fabric	_____	_____	_____	_____	_____	_____	_____	_____	_____	_____	_____	_____	_____	_____	_____	_____	_____	_____
(3) Faux Leather	_____	_____	_____	_____	_____	_____	_____	_____	_____	_____	_____	_____	_____	_____	_____	_____	_____	_____
Back Upholstery	_____	_____	_____	_____	_____	_____	_____	_____	_____	_____	_____	_____	_____	_____	_____	_____	_____	_____
(0) Knit	_____	_____	_____	_____	_____	_____	_____	_____	_____	_____	_____	_____	_____	_____	_____	_____	_____	_____
(1) Leather	_____	_____	_____	_____	_____	_____	_____	_____	_____	_____	_____	_____	_____	_____	_____	_____	_____	_____
(2) Fabric	_____	_____	_____	_____	_____	_____	_____	_____	_____	_____	_____	_____	_____	_____	_____	_____	_____	_____
(3) Faux Leather	_____	_____	_____	_____	_____	_____	_____	_____	_____	_____	_____	_____	_____	_____	_____	_____	_____	_____
(C) Cleanable	_____	_____	_____	_____	_____	_____	_____	_____	_____	_____	_____	_____	_____	_____	_____	_____	_____	_____
Arms	_____	_____	_____	_____	_____	_____	_____	_____	_____	_____	_____	_____	_____	_____	_____	_____	_____	_____
(0) No Arms	_____	_____	_____	_____	_____	_____	_____	_____	_____	_____	_____	_____	_____	_____	_____	_____	_____	_____
(1) Fixed Arms	_____	_____	_____	_____	_____	_____	_____	_____	_____	_____	_____	_____	_____	_____	_____	_____	_____	_____
(4) Height Adjustable Arms	_____	_____	_____	_____	_____	_____	_____	_____	_____	_____	_____	_____	_____	_____	_____	_____	_____	_____
(7) 4D Arms	_____	_____	_____	_____	_____	_____	_____	_____	_____	_____	_____	_____	_____	_____	_____	_____	_____	_____
Lumbar	_____	_____	_____	_____	_____	_____	_____	_____	_____	_____	_____	_____	_____	_____	_____	_____	_____	_____
(0) No Lumbar	_____	_____	_____	_____	_____	_____	_____	_____	_____	_____	_____	_____	_____	_____	_____	_____	_____	_____
(1) Lumbar	_____	_____	_____	_____	_____	_____	_____	_____	_____	_____	_____	_____	_____	_____	_____	_____	_____	_____
Back Lock/Forward Tilt	_____	_____	_____	_____	_____	_____	_____	_____	_____	_____	_____	_____	_____	_____	_____	_____	_____	_____
(1) Back Lock	_____	_____	_____	_____	_____	_____	_____	_____	_____	_____	_____	_____	_____	_____	_____	_____	_____	_____
(4) Back Lock with Forward Tilt	_____	_____	_____	_____	_____	_____	_____	_____	_____	_____	_____	_____	_____	_____	_____	_____	_____	_____
Seat Adjustment	_____	_____	_____	_____	_____	_____	_____	_____	_____	_____	_____	_____	_____	_____	_____	_____	_____	_____
(A) Adjustable	_____	_____	_____	_____	_____	_____	_____	_____	_____	_____	_____	_____	_____	_____	_____	_____	_____	_____
(X) Fixed	_____	_____	_____	_____	_____	_____	_____	_____	_____	_____	_____	_____	_____	_____	_____	_____	_____	_____
Base	_____	_____	_____	_____	_____	_____	_____	_____	_____	_____	_____	_____	_____	_____	_____	_____	_____	_____
(1) Aluminum Standard Base, Hard Caster	_____	_____	_____	_____	_____	_____	_____	_____	_____	_____	_____	_____	_____	_____	_____	_____	_____	_____
(2) Aluminum Standard Base, Soft Caster	_____	_____	_____	_____	_____	_____	_____	_____	_____	_____	_____	_____	_____	_____	_____	_____	_____	_____
(3) Aluminum Low Base, Hard Caster	_____	_____	_____	_____	_____	_____	_____	_____	_____	_____	_____	_____	_____	_____	_____	_____	_____	_____
(4) Aluminum Low Base, Soft Caster	_____	_____	_____	_____	_____	_____	_____	_____	_____	_____	_____	_____	_____	_____	_____	_____	_____	_____
(5) Plastic Standard Base, Hard Caster	_____	_____	_____	_____	_____	_____	_____	_____	_____	_____	_____	_____	_____	_____	_____	_____	_____	_____
(6) Plastic Standard Base, Soft Caster	_____	_____	_____	_____	_____	_____	_____	_____	_____	_____	_____	_____	_____	_____	_____	_____	_____	_____
(7) Plastic Standard Base, Two-Tone Caster	_____	_____	_____	_____	_____	_____	_____	_____	_____	_____	_____	_____	_____	_____	_____	_____	_____	_____
(T) Aluminum Standard Base, Two-Tone Caster	_____	_____	_____	_____	_____	_____	_____	_____	_____	_____	_____	_____	_____	_____	_____	_____	_____	_____
Shipping Method	_____	_____	_____	_____	_____	_____	_____	_____	_____	_____	_____	_____	_____	_____	_____	_____	_____	_____
(A) Fully Assembled	_____	_____	_____	_____	_____	_____	_____	_____	_____	_____	_____	_____	_____	_____	_____	_____	_____	_____
(K) Knocked Down	_____	_____	_____	_____	_____	_____	_____	_____	_____	_____	_____	_____	_____	_____	_____	_____	_____	_____
Seat Upholstery	_____	_____	_____	_____	_____	_____	_____	_____	_____	_____	_____	_____	_____	_____	_____	_____	_____	_____
Tellure	_____	_____	_____	_____	_____	_____	_____	_____	_____	_____	_____	_____	_____	_____	_____	_____	_____	_____
Back Upholstery	_____	_____	_____	_____	_____	_____	_____	_____	_____	_____	_____	_____	_____	_____	_____	_____	_____	_____
Knit	_____	_____	_____	_____	_____	_____	_____	_____	_____	_____	_____	_____	_____	_____	_____	_____	_____	_____
Trim Color (Plastic components)	_____	_____	_____	_____	_____	_____	_____	_____	_____	_____	_____	_____	_____	_____	_____	_____	_____	_____
Black	_____	_____	_____	_____	_____	_____	_____	_____	_____	_____	_____	_____	_____	_____	_____	_____	_____	_____
Base Color (Plastic or Aluminum)	_____	_____	_____	_____	_____	_____	_____	_____	_____	_____	_____	_____	_____	_____	_____	_____	_____	_____
Metallic Silver	_____	_____	_____	_____	_____	_____	_____	_____	_____	_____	_____	_____	_____	_____	_____	_____	_____	_____

# Soji At-A-Glance

## General Specifications

<b>Designer</b>	Haworth Design Studio
<b>Soji</b>	Soji is a highly-adjustable task chair with more ergonomic options than most task seating in its class—without sacrificing comfort or design.
<b>Environmental Factors</b>	Refer to the Product Environmental Data sheet (PED) for recycled content and certifications. Soji is part of the Haworth Take Back Program. Manufactured in a zero landfill, ISO 14001 certified facility in Mississippi, USA.
<b>Finishes and Fabrics</b>	A complete listing of finishes and fabrics for Soji task chairs is available in the back of the price list.
<b>COM &amp; COL General Information</b>	<p>To order a COM fabric (Customer's Own Material) contact the Haworth Inquiry Center (1.800.462.8562), your local Haworth dealer, or go to <a href="https://surfaces.haworth.com">Surfaces.haworth.com</a> to find out if the COM you have selected has already been tested and approved. The surface collection site also has information on the Haworth alliance program with Carnegie, Luna Textiles, and Maharam as well as our industry-leading Pre-Approved COM program.</p> <p>COM fabrics are placed into Grades based on the cost per linear yard. If a fabric's cost exceeds the range of our highest Grade it will be noted as Non-Graded. The product will be priced at Grade A; the COM fabric costs will appear as a separate line item. The fabric charge will be Haworth's purchase cost plus a 4% administrative fee (based on the cost of the fabric). Yardage calculations will include any applicable fabric repeat.</p> <p>COM Leather products will be priced at a leather Grade A; COL costs will appear as a separate line item. The leather costs will be Haworth's purchase cost plus a 4% administrative fee (based on the cost of the leather).</p>
<b>Stain Repellent</b>	<p>Stain Repellent or Stain Repellent with Moisture Barrier available on fabric surfaces only.</p> <p>Stain Repellent only: To specify add "<b>P</b>" to the end of the product number. Example: SJT-20-711A5AP</p> <p>Stain Repellent with Moisture Barrier: To specify add "<b>D</b>" to the end of the product number. Example: SJT-20-711A5AD</p>
<b>Shipping Weights/Cube (Including packaging)</b>	<ul style="list-style-type: none"> <li>• Assembled <ul style="list-style-type: none"> <li>-With arms - 46 lbs. / 16.5 cubic feet</li> <li>-Armless - 41.4 lbs. / 16.5 cubic feet</li> </ul> </li> <li>• Knocked Down <ul style="list-style-type: none"> <li>-With arms - 42 lbs. / 12.2 cubic feet</li> <li>-Armless - 37.4 lbs. / 12.2 cubic feet</li> </ul> </li> </ul>

# Soji At-A-Glance

## General Specifications

### STANDARD MOBILITY AND ADJUSTABILITY

#### Seat Height Adjustment

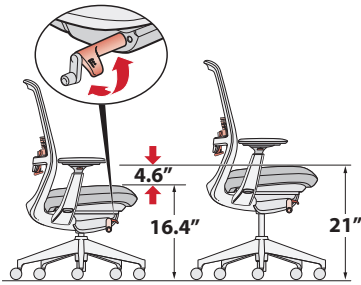

#### Features:

- Pneumatic seat height adjustment.
- Seat height adjusts 4.6"(117mm) from 16.4" to 21.0"(417mm-533mm) on standard models. Low-position adjusts from 14.75" to 17.5"(375mm-445mm). Stool adjusts from 22" to 29.5"(559mm-749mm).

#### Benefits:

- Ensures the comfort of the lower limbs by avoiding pressure on the underside of the thigh caused by a seat pan that is too high, or decreased thigh-to-torso angle if the seat is too low.
- Seat height adjustment is important in setting the proper hand position and allowing for proper sitting eye height as well.

#### Seat Depth Adjustment

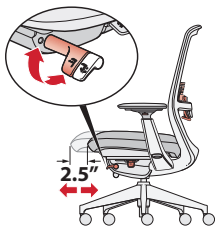

#### Feature:

- Optional seat depth has 2.5"(64mm) seat depth range. Fixed seat also available.

#### Benefit:

- Supports the thighs, allows users to rest against the seat back for back support, and avoids pressure on the back of the knees of small to tall users.

#### Synchronous Tilt Mechanism



#### Features:

- Back reclines 23° from the upright position.
- 2:1 recline ratio.

#### Benefits:

- Comfortable relaxed posture.
- Recline allows for the opening of the user's chest cavity providing good airflow to promote alertness.
- User's feet remain flat on the floor.

#### Tilt Tension Control

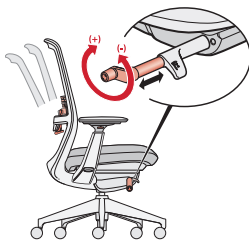

#### Feature:

- Regulates the amount of resistance felt when leaning back in the chair and the effort required to recline the chair backwards.

#### Benefit:

- Personalized support to accommodate users of different body types and different work styles.

#### Forward Tilt

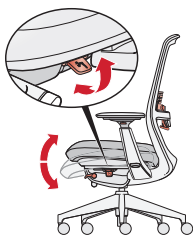

#### Feature:

- Optional forward tilt allows seat pan to move 5° downward from the initial position.
- Forward tilt not available on task stool.

#### Benefit:

- Allows user the opportunity to vary their posture throughout the day.

# Soji At-A-Glance

## General Specifications

### STANDARD MOBILITY AND ADJUSTABILITY

#### Back Lock

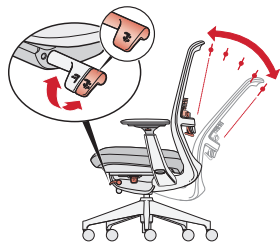

**Feature:**

- Single position back lock.

**Benefit:**

- Allows users to lock the back of the chair in the upright position for tasking applications.

#### Lumbar Support

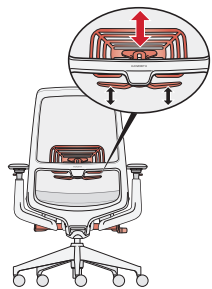

**Features:**

- Optional height adjustable lumbar.
- Range of 3.5"(89mm) of height adjustment.
- Available in Black or Fog. Lumbar will be black if Carbon knit is ordered or plastic trim color is black. Lumbar will be Fog if plastic trim is specified as Fog or Snow and knit is not Carbon.

**Benefits:**

- Provides additional support in the lower back.
- Lumbar adjustment maintains the natural curvature of the spine at the lower back and allows the user to position the support to where it is most comfortable.

#### 4D Arm

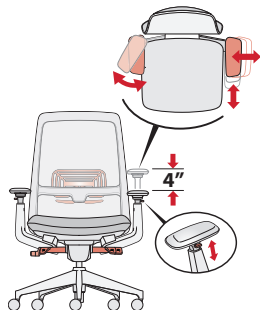

**Features:**

- Optional 4D arm adjusts in 4 ways:
  - Height adjustment 4"(102mm)
  - Side-to-side arm cap adjustment range: 3"(76mm) [1.5"(38mm) each arm cap]
  - Front-to-back adjustment range: 3.5"(89mm)
  - Pivoting 20° in and 20° out

**Benefits:**

- Arms support the muscular system of user's neck and shoulders; proper arm support provides back relief.
- Arms can be an aid in standing or sitting down.
- Height adjustment accommodates for users with varying elbow rest heights so that users avoid lifting their shoulders or leaning sideways to get arm support.
- Front-to-back adjustment adjusts the armrest length, which is important because it allows users to get close to the worksurface while maintaining the effective use of the backrest.
- Side-to-side adjustment ensures a comfortable resting position for the arms with proper support of the forearm while allowing for easy entry/exit of the chair.
- Pivoting provides proper support of the forearm when performing tasks involving keying and mousing.

#### Height Adjustable Arm

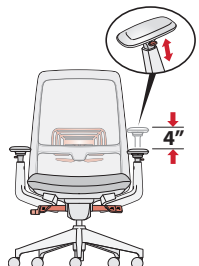

**Feature:**

- Optional height adjustable arms adjust 4"(102mm) vertically.

**Benefit:**

- Height adjustment accommodates users with varying elbow rest heights so that users avoid lifting their shoulders or leaning sideways to get arm support.

**Soji At-A-Glance**

General Specifications

STANDARD MOBILITY AND ADJUSTABILITY

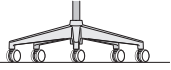
**Base****Standard Plastic Base****Colors:**

Fog, Black

**Casters:**

Hard: Black or Two-Tone Grey

Soft: Black

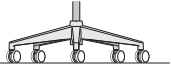
**Aluminum Base****Colors:**

Painted Black or Metallic Silver or Polished aluminum

**Casters:**

Hard: Black or Two-Tone Grey

Soft: Black

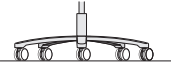
**Low Position Base  
(Aluminum only)****Colors:**

Painted Black or Metallic Silver

**Casters:**

Hard: Black

Soft: Black

**Leather Upholstery****Features:**

- Leather will have double stitched seams vertically in the center of the back and seat cushion as well as on the edges of the seat cushion.

**Cleanable Upholstery****Features:**

- Seamless Faux Leather inner back.
- Outer back will be backed with Faux Leather for full cleanability.
  - Black trim will default to Wellington Black
  - Fog or Snow trim will default to Wellington Storm
- Inner back for cleanable upholstery must also be specified in Faux Leather. Refer to [surfaces.haworth.com](https://surfaces.haworth.com) for available options.
- To specify, change the back upholstery option to "C". Example: SJT-3**C**-701X5A

# Soji At-A-Glance

## General Specifications

### Features

**Pneumatic seat height adjustment:**

- Standard model adjusts 16.4"-21"
- Low position model adjusts 14.75"-17.5"
- Stool adjusts 22"-29.5"

Synchronous tilt mechanism provides 23° of back recline.

Standard tilt mechanism control regulates the amount of resistance of the back.

Standard five-star base in plastic or optional aluminum. Optional low position base in aluminum.

Hard casters available for carpet flooring and soft casters for hard flooring.

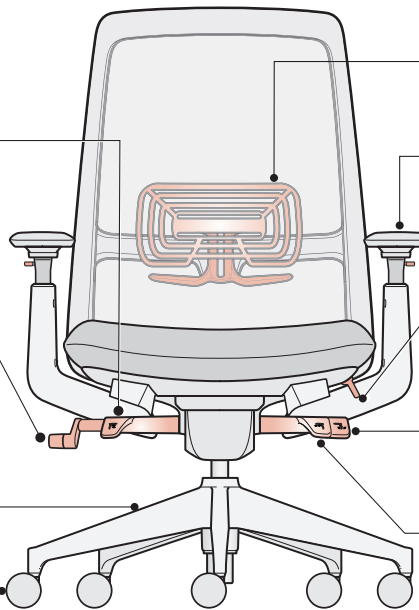

Front View

Optional height adjustable lumbar has 3.5" of height adjustment.

Arms available fixed, height adjustable and 4D; armless.

Optional forward tilt allows seat pan to move downward 5° from the initial position. Forward tilt not available on stool.

Single position back lock to lock back of chair in the upright position.

Seat standard fixed or optional adjustable (2.5" seat depth range).

### Aesthetic Options

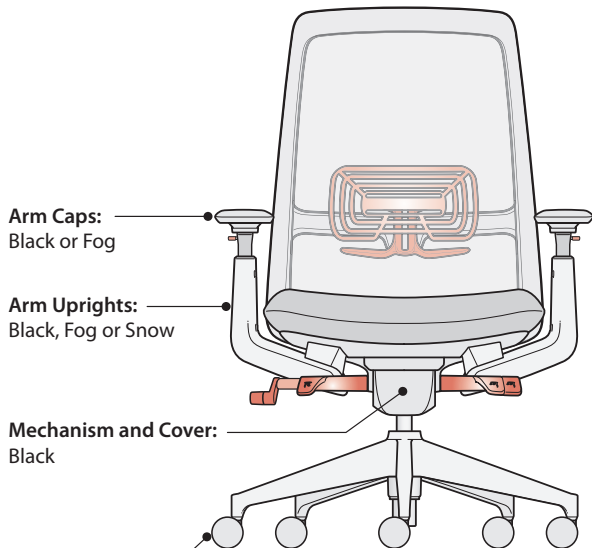

- Arm Caps:** Black or Fog
- Arm Uprights:** Black, Fog or Snow
- Mechanism and Cover:** Black
- Casters:**
- Hard: Black or Two-Tone Grey
  - Soft: Black

Front View

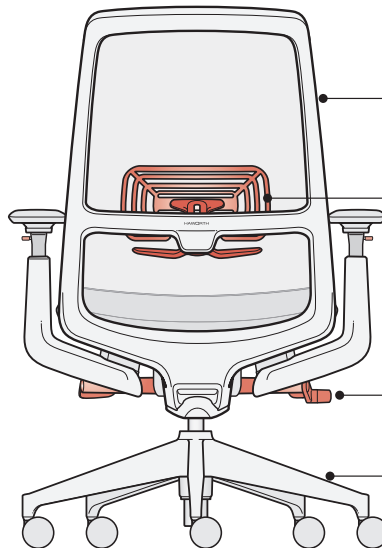

**Frame:** Black, Fog or Snow

**Lumbar:** Black or Fog

**Controls:** Black

**Base:**

- Plastic: Black or Fog
- Aluminum: Black, Metallic Silver or Polished Aluminum

Back View



SJT-20-711A

**Dimensions**

- \*SH: 16.4"-21.0"  
(417mm-533mm)
- H: 39"-44"  
(991mm-1118mm)
- D: 27"(686mm)
- W: 28"(711mm)
- \*SW: 20"(508mm)
- \*SD: 16.25"-18.75"  
(413mm-476mm)
- \*AH: 7.4"-11.4"  
(188mm-290mm)

\* All measurements taken with the BIFMA chair measuring device.

**Features**

- Back: Knit or upholstered.
- Seat: Standard upholstered foam covered in leather, fabric or faux leather. Available as a fixed seat or with seat depth adjustment (2.5"(64mm) range).
- Base: Plastic five-star base.
- Arms: 4D arms have height adjustment range of 4"(102mm). Arms move front to back, side to side and pivot in and out.
- Lumbar: Available with optional lumbar support with 3.5"(89mm) adjustment.
- Mechanism: Synchronized tilt; standard tilt tension adjustment.
- Height adjustment: Standard pneumatic.
- Back Lock: Standard single position upright back lock.
- Optional Forward Tilt: 5° downward from initial position. Only available on chairs with seat depth adjustment.
- Casters: Hard casters in black or two-tone grey; Soft casters black only.
- COM yardage/COL square footage:  
Seat: 0.75/7  
Back: 1.25/12

**To Order, Specify:**

- 1) Product number, including;
  - 1 Seat Upholstery:**
    - 1 Leather
    - 2 Fabric
    - 3 Faux Leather
  - 2 Back Upholstery:**
    - 0 Knit
    - 1 Leather
    - 2 Fabric
    - 3 Faux Leather
  - 3 Caster Option:**
    - 5 Hard Casters (Black)
    - 6 Soft Casters (Black), add **\$57.29** to list
    - 7 Hard Two-Tone Casters (Grey)
- 2) Seat surface material and color.
- 3) Back surface material and color.
- 4) Plastic trim color (frame and arm uprights).  
TR-F Black  
TR-7 Fog, add **\$92.13** list.  
TR-UFM Snow, add **\$148.82** list.
- 5) Base color.  
TR-F Black  
TR-7 Fog

**Specification Tips**

- Ships standard assembled. Optional knocked down shipment comes in three pieces; assembly does not require tools.
- Lumbar color defaults based on chair attributes and is available in Black or Fog only.  
–Black will be received if Carbon knit is ordered or plastic trim color is Black.  
–Fog will be received if Fog or Snow plastic trim is ordered and knit is not Carbon.
- Reference color chart for applied backing material for upholstered or cleanable upholstery back.

Plastic Trim Color	Lumbar	Arm Caps	Backing Material for Upholstered Back
TR-F Black	TR-F Black	TR-F Black	Tellure, Black 3A-18
TR-7 Fog	TR-7 Fog*	TR-7 Fog	Tellure, Goose 3A-54
TR-UFM Snow	TR-7 Fog*	TR-7 Fog	Tellure, Goose 3A-54

\*If knit is Carbon, lumbar will be Black.

Plastic Trim Color	Lumbar	Arm Caps	Backing Material for Cleanable Upholstered Back
TR-F Black	TR-F Black	TR-F Black	Wellington, Black XJ-BL
TR-7 Fog	TR-7 Fog*	TR-7 Fog	Wellington, Steel XJ-SL
TR-UFM Snow	TR-7 Fog*	TR-7 Fog	Wellington, Steel XJ-SL

\*If knit is Carbon, lumbar will be Black.

Description	Number			Fabric Grade								Leather Grade A	Leather Grade B
	1	2	3	A	B	C	D	E	F	G	H		
<b>Knit Back, No Lumbar Adjustment</b>													
Back Lock w/Fixed Seat	SJT-	0-701X	A	\$ 993.23	\$1037.85	\$1085.68	\$1108.04	\$1127.15	\$1168.61	\$1206.87	\$1308.90	\$1399.77	\$1599.06
Back Lock w/Seat Depth Adjustment	SJT-	0-701A	A	1021.59	1066.21	1114.04	1136.40	1155.51	1196.97	1235.23	1337.26	1428.13	1627.42
Back Lock & Forward Tilt w/Seat Depth Adjustment	SJT-	0-704A	A	1072.66	1117.28	1165.11	1187.47	1206.58	1248.04	1286.30	1388.33	1479.20	1678.49
<b>Upholstered Back, No Lumbar Adjustment</b>													
Back Lock w/Fixed Seat	SJT-	-701X	A	\$1141.81	\$1231.05	\$1326.71	\$1371.43	\$1409.65	\$1492.57	\$1569.09	\$1773.15	\$1954.89	\$2353.47
Back Lock w/Seat Depth Adjustment	SJT-	-701A	A	1170.17	1259.41	1355.07	1399.79	1438.01	1520.93	1597.45	1801.51	1983.25	2381.83
Back Lock & Forward Tilt w/Seat Depth Adjustment	SJT-	-704A	A	1221.24	1310.48	1406.14	1450.86	1489.08	1572.00	1648.52	1852.58	2034.32	2432.90
<b>Knit Back, Lumbar Adjustment</b>													
Back Lock w/Fixed Seat	SJT-	0-711X	A	\$1061.26	\$1105.88	\$1153.71	\$1176.07	\$1195.18	\$1236.64	\$1274.90	\$1376.93	\$1467.80	\$1667.09
Back Lock w/Seat Depth Adjustment	SJT-	0-711A	A	1089.62	1134.24	1182.07	1204.43	1223.54	1265.00	1303.26	1405.29	1496.16	1695.45
Back Lock & Forward Tilt w/Seat Depth Adjustment	SJT-	0-714A	A	1140.69	1185.31	1233.14	1255.50	1274.61	1316.07	1354.33	1456.36	1547.23	1746.52
<b>Upholstered Back, Lumbar Adjustment</b>													
Back Lock w/Fixed Seat	SJT-	-711X	A	\$1209.84	\$1299.08	\$1394.74	\$1439.46	\$1477.68	\$1560.60	\$1637.12	\$1841.18	\$2022.92	\$2421.50
Back Lock w/Seat Depth Adjustment	SJT-	-711A	A	1238.20	1327.44	1423.10	1467.82	1506.04	1588.96	1665.48	1869.54	2051.28	2449.86
Back Lock & Forward Tilt w/Seat Depth Adjustment	SJT-	-714A	A	1289.27	1378.51	1474.17	1518.89	1557.11	1640.03	1716.55	1920.61	2102.35	2500.93

The following options require modification of the product number.

- Knocked Down Shipment To specify, change the 11th digit from an **A** to **K** and deduct **\$42.52** list; **Example:** SJT-20-701X5K
  - Stain Repellent (Fabric seat only) To specify, add **P** to the end of the product number and add **\$49.61** list; **Example:** SJT-20-701X5AP
  - Fully Cleanable Back To specify, change the 5th digit to **C** and add **\$38.95** list to upholstered back list price; **Example:** SJT-3C-701X5A
- Note:** Inner back must be Faux Leather to have a fully cleanable back.

# Soji

## Task Chair with 4D Arms — Aluminum Base



SJT-20-711A

### Dimensions

- \*SH: 16.4"-21.0"  
(417mm-533mm)
- H: 39"-44"  
(991mm-1118mm)
- D: 27"(686mm)
- W: 28"(711mm)
- \*SW: 20"(508mm)
- \*SD: 16.25"-18.75"  
(413mm-476mm)
- \*AH: 7.4"-11.4"  
(188mm-290mm)

Low position seat height:  
14.75"-17.5"  
(375mm-445mm)

\* All measurements taken with the BIFMA chair measuring device.

### Features

- Back: Knit or upholstered.
- Seat: Standard upholstered foam covered in leather, fabric or faux leather. Available as a fixed seat or with seat depth adjustment (2.5"(64mm) range).
- Base: Aluminum five-star base.
- Arms: 4D arms have height adjustment range of 4"(102mm). Arms move front to back, side to side and pivot in and out.
- Lumbar: Available with optional lumbar support with 3.5"(89mm) adjustment.
- Mechanism: Synchronized tilt; standard tilt tension adjustment.
- Height adjustment: Standard pneumatic.
- Back Lock: Standard single position upright back lock.
- Optional Forward Tilt: 5° downward from initial position. Only available on chairs with seat depth adjustment.
- Casters: Hard casters in black or two-tone grey; Soft casters black only.
- COM yardage/COL square footage:  
Seat: 0.75/7  
Back: 1.25/12

### To Order, Specify:

1) Product number, including;

#### 1 Seat Upholstery:

- 1 Leather
- 2 Fabric
- 3 Faux Leather

#### 2 Back Upholstery:

- 0 Knit
- 1 Leather
- 2 Fabric
- 3 Faux Leather

#### 3 Caster Option: Standard Base

- 1 Std. Base Hard Casters (Black)
- 2 Std. Base Soft Casters (Black), add \$57.29 to list
- T Std. Base Hard Two-Tone Casters (Grey)

### Low Base

- 3 Low Base, Hard Casters (Black)
- 4 Low Base, Soft Casters (Black), add \$57.29 to list

2) Seat surface material and color.

3) Back surface material and color.

4) Plastic trim color (frame and arm uprights).  
TR-F Black  
TR-7 Fog, add \$92.13 list.  
TR-UFM Snow, add \$148.82 list.

5) Base color.  
TR-F Black  
TR-LE Metallic Silver  
PM-P Polished Aluminum, add \$135.06 list.

### Specification Tips

- Ships standard assembled. Optional knocked down shipment comes in three pieces; assembly does not require tools.
- Lumbar color defaults based on chair attributes and is available in Black or Fog only.  
–Black will be received if Carbon knit is ordered or plastic trim color is Black.  
–Fog will be received if Fog or Snow plastic trim is ordered and knit is not Carbon.
- Reference color chart for applied backing material for upholstered or cleanable upholstery back.

Plastic Trim Color	Lumbar	Arm Caps	Backing Material for Upholstered Back
TR-F Black	TR-F Black	TR-F Black	Tellure, Black 3A-18
TR-7 Fog	TR-7 Fog*	TR-7 Fog	Tellure, Goose 3A-54
TR-UFM Snow	TR-7 Fog*	TR-7 Fog	Tellure, Goose 3A-54

\*If knit is Carbon, lumbar will be Black.

Plastic Trim Color	Lumbar	Arm Caps	Backing Material for Cleanable Upholstered Back
TR-F Black	TR-F Black	TR-F Black	Wellington, Black XJ-BL
TR-7 Fog	TR-7 Fog*	TR-7 Fog	Wellington, Steel XJ-SL
TR-UFM Snow	TR-7 Fog*	TR-7 Fog	Wellington, Steel XJ-SL

\*If knit is Carbon, lumbar will be Black.

Description	Number			Fabric Grade						Leather			
	1	2	3	A	B	C	D	E	F	G	H	Grade A	Grade B
<b>Knit Back, No Lumbar Adjustment</b>													
Back Lock w/Fixed Seat	SJT-	0-701X	A	\$1081.32	\$1125.94	\$1173.77	\$1196.13	\$1215.24	\$1256.70	\$1294.96	\$1396.99	\$1487.86	\$1687.15
Back Lock w/Seat Depth Adjustment	SJT-	0-701A	A	\$1109.68	\$1154.30	\$1202.13	\$1224.49	\$1243.60	\$1285.06	\$1323.32	\$1425.35	\$1516.22	\$1715.51
Back Lock & Forward Tilt w/Seat Depth Adjustment	SJT-	0-704A	A	\$1160.75	\$1205.37	\$1253.20	\$1275.56	\$1294.67	\$1336.13	\$1374.39	\$1476.42	\$1567.29	\$1766.58
<b>Upholstered Back, No Lumbar Adjustment</b>													
Back Lock w/Fixed Seat	SJT-	-701X	A	\$1229.90	\$1319.14	\$1414.80	\$1459.52	\$1497.74	\$1580.66	\$1657.18	\$1861.24	\$2042.98	\$2441.56
Back Lock w/Seat Depth Adjustment	SJT-	-701A	A	\$1258.26	\$1347.50	\$1443.16	\$1487.88	\$1526.10	\$1609.02	\$1685.54	\$1889.60	\$2071.34	\$2469.92
Back Lock & Forward Tilt w/Seat Depth Adjustment	SJT-	-704A	A	\$1309.33	\$1398.57	\$1494.23	\$1538.95	\$1577.17	\$1660.09	\$1736.61	\$1940.67	\$2122.41	\$2520.99
<b>Knit Back, Lumbar Adjustment</b>													
Back Lock w/Fixed Seat	SJT-	0-711X	A	\$1149.35	\$1193.97	\$1241.80	\$1264.16	\$1283.27	\$1324.73	\$1362.99	\$1465.02	\$1555.89	\$1755.18
Back Lock w/Seat Depth Adjustment	SJT-	0-711A	A	\$1177.71	\$1222.33	\$1270.16	\$1292.52	\$1311.63	\$1353.09	\$1391.35	\$1493.38	\$1584.25	\$1783.54
Back Lock & Forward Tilt w/Seat Depth Adjustment	SJT-	0-714A	A	\$1228.78	\$1273.40	\$1321.23	\$1343.59	\$1362.70	\$1404.16	\$1442.42	\$1544.45	\$1635.32	\$1834.61
<b>Upholstered Back, Lumbar Adjustment</b>													
Back Lock w/Fixed Seat	SJT-	-711X	A	\$1297.93	\$1387.17	\$1482.83	\$1527.55	\$1565.77	\$1648.69	\$1725.21	\$1929.27	\$2111.01	\$2509.59
Back Lock w/Seat Depth Adjustment	SJT-	-711A	A	\$1326.29	\$1415.53	\$1511.19	\$1555.91	\$1594.13	\$1677.05	\$1753.57	\$1957.63	\$2139.37	\$2537.95
Back Lock & Forward Tilt w/Seat Depth Adjustment	SJT-	-714A	A	\$1377.36	\$1466.60	\$1562.26	\$1606.98	\$1645.20	\$1728.12	\$1804.64	\$2008.70	\$2190.44	\$2589.02

The following options require modification of the product number.

- Knocked Down Shipment
- Stain Repellent (Fabric seat only)
- Fully Cleanable Back

To specify, change the 11th digit from an **A** to **K** and deduct \$42.52 list; **Example:** SJT-20-701X1K

To specify, add **P** to the end of the product number and add \$49.61 list; **Example:** SJT-20-701X1AP

To specify, change the 5th digit to **C** and add \$38.95 list to upholstered back list price; **Example:** SJT-3C-701X1A

**Note:** Inner back must be Faux Leather to have a fully cleanable back.





SJT-20-401X

**Dimensions**

- \*SH: 16.4"-21.0"  
(417mm-533mm)
- H: 39"-44"  
(991mm-1118mm)
- D: 27"(686mm)
- W: 28"(711mm)
- \*SW: 20"(508mm)
- \*SD: 16.25"-18.75"  
(413mm-476mm)
- \*AH: 7.4"-11.4"  
(188mm-290mm)

\* All measurements taken with the BIFMA chair measuring device.

**Features**

- Back: Knit or upholstered.
- Seat: Standard upholstered foam covered in leather, fabric or faux leather. Available as a fixed seat or with seat depth adjustment (2.5"(64mm) range).
- Base: Plastic five-star base.
- Arms: Height adjustable with 4"(102mm) range.
- Lumbar: Available with optional lumbar support with 3.5"(89mm) adjustment.
- Mechanism: Synchronized tilt; standard tilt tension adjustment.
- Height adjustment: Standard pneumatic.
- Back Lock: Standard single position upright back lock.
- Optional Forward Tilt: 5° downward from initial position. Only available on chairs with seat depth adjustment.
- Casters: Hard casters in black or two-tone grey; Soft casters black only.
- COM yardage/COL square footage:  
Seat: 0.75/7  
Back: 1.25/12

**To Order, Specify:**

1) Product number, including;

**1 Seat Upholstery:**

- 1 Leather
- 2 Fabric
- 3 Faux Leather

**2 Back Upholstery:**

- 0 Knit
- 1 Leather
- 2 Fabric
- 3 Faux Leather

**3 Caster Option:**

- 5 Hard Casters (Black)
- 6 Soft Casters (Black), add \$57.29 to list
- 7 Hard Two-Tone Casters (Grey)

Plastic Trim Color	Lumbar	Arm Caps	Backing Material for Upholstered Back
TR-F Black	TR-F Black	TR-F Black	Tellure, Black 3A-18
TR-7 Fog	TR-7 Fog*	TR-7 Fog	Tellure, Goose 3A-54
TR-UFM Snow	TR-7 Fog*	TR-7 Fog	Tellure, Goose 3A-54

\*If knit is Carbon, lumbar will be Black.

Plastic Trim Color	Lumbar	Arm Caps	Backing Material for Cleanable Upholstered Back
TR-F Black	TR-F Black	TR-F Black	Wellington, Black XJ-BL
TR-7 Fog	TR-7 Fog*	TR-7 Fog	Wellington, Steel XJ-SL
TR-UFM Snow	TR-7 Fog*	TR-7 Fog	Wellington, Steel XJ-SL

\*If knit is Carbon, lumbar will be Black.

**Specification Tips**

- Ships standard assembled. Optional knocked down shipment comes in three pieces; assembly does not require tools.
- Lumbar color defaults based on chair attributes and is available in Black or Fog only.
  - Black will be received if Carbon knit is ordered or plastic trim color is Black.
  - Fog will be received if Fog or Snow plastic trim is ordered and knit is not Carbon.
- Reference color chart for applied backing material for upholstered or cleanable upholstery back.

- 2) Seat surface material and color.
- 3) Back surface material and color.
- 4) Plastic trim color (frame and arm uprights).
  - TR-F Black
  - TR-7 Fog, add \$92.13 list.
  - TR-UFM Snow, add \$148.82 list.
- 5) Base color.
  - TR-F Black
  - TR-7 Fog

Description	Number			Fabric Grade								Leather Grade A	Leather Grade B
	1	2	3	A	B	C	D	E	F	G	H		
<b>Knit Back, No Lumbar Adjustment</b>													
Back Lock w/Fixed Seat	SJT-	0-401X	A	\$ 966.63	\$1011.25	\$1059.08	\$1081.44	\$1100.55	\$1142.01	\$1180.27	\$1282.30	\$1373.17	\$1572.46
Back Lock w/Seat Depth Adjustment	SJT-	0-401A	A	994.99	1039.61	1087.44	1109.80	1128.91	1170.37	1208.63	1310.66	1401.53	1600.82
Back Lock & Forward Tilt w/Seat Depth Adjustment	SJT-	0-404A	A	1046.06	1090.68	1138.51	1160.87	1179.98	1221.44	1259.70	1361.73	1452.60	1651.89
<b>Upholstered Back, No Lumbar Adjustment</b>													
Back Lock w/Fixed Seat	SJT-	-401X	A	\$1115.21	\$1204.45	\$1300.11	\$1344.83	\$1383.05	\$1465.97	\$1542.49	\$1746.55	\$1928.29	\$2326.87
Back Lock w/Seat Depth Adjustment	SJT-	-401A	A	1143.57	1232.81	1328.47	1373.19	1411.41	1494.33	1570.85	1774.91	1956.65	2355.23
Back Lock & Forward Tilt w/Seat Depth Adjustment	SJT-	-404A	A	1194.64	1283.88	1379.54	1424.26	1462.48	1545.40	1621.92	1825.98	2007.72	2406.30
<b>Knit Back, Lumbar Adjustment</b>													
Back Lock w/Fixed Seat	SJT-	0-411X	A	\$1034.66	\$1079.28	\$1127.11	\$1149.47	\$1168.58	\$1210.04	\$1248.30	\$1350.33	\$1441.20	\$1640.49
Back Lock w/Seat Depth Adjustment	SJT-	0-411A	A	1063.02	1107.64	1155.47	1177.83	1196.94	1238.40	1276.66	1378.69	1469.56	1668.85
Back Lock & Forward Tilt w/Seat Depth Adjustment	SJT-	0-414A	A	1114.09	1158.71	1206.54	1228.90	1248.01	1289.47	1327.73	1429.76	1520.63	1719.92
<b>Upholstered Back, Lumbar Adjustment</b>													
Back Lock w/Fixed Seat	SJT-	-411X	A	\$1183.24	\$1272.48	\$1368.14	\$1412.86	\$1451.08	\$1534.00	\$1610.52	\$1814.58	\$1996.32	\$2394.90
Back Lock w/Seat Depth Adjustment	SJT-	-411A	A	1211.60	1300.84	1396.50	1441.22	1479.44	1562.36	1638.88	1842.94	2024.68	2423.26
Back Lock & Forward Tilt w/Seat Depth Adjustment	SJT-	-414A	A	1262.67	1351.91	1447.57	1492.29	1530.51	1613.43	1689.95	1894.01	2075.75	2474.33

The following options require modification of the product number.

- Knocked Down Shipment To specify, change the 11th digit from an **A** to **K** and deduct \$42.52 list; **Example:** SJT-20-401X5K
- Stain Repellent (Fabric seat only) To specify, add **P** to the end of the product number and add \$49.61 list; **Example:** SJT-20-401X5AP
- Fully Cleanable Back To specify, change the 5th digit to **C** and add \$38.95 list to upholstered back list price; **Example:** SJT-3C-401X5A

**Note:** Inner back must be Faux Leather to have a fully cleanable back.

# Soji

## Task Chair with Height Adjustable Arms — Aluminum Base



SJT-20-411X

### Dimensions

- \*SH: 16.4"-21.0"  
(417mm-533mm)
- H: 39"-44"  
(991mm-1118mm)
- D: 27"(686mm)
- W: 28"(711mm)
- \*SW: 20"(508mm)
- \*SD: 16.25"-18.75"  
(413mm-476mm)
- \*AH: 7.4"-11.4"  
(188mm-290mm)

Low position seat height:  
14.75"-17.5"  
(375mm-445mm)

\* All measurements taken with the BIFMA chair measuring device.

### Features

- Back: Knit or upholstered.
- Seat: Standard upholstered foam covered in leather, fabric or faux leather. Available as a fixed seat or with seat depth adjustment (2.5"(64mm) range).
- Base: Aluminum five-star base.
- Arms: Height adjustable with 4"(102mm) range.
- Lumbar: Available with optional lumbar support with 3.5"(89mm) adjustment.
- Mechanism: Synchronized tilt; standard tilt tension adjustment.
- Height adjustment: Standard pneumatic.
- Back Lock: Standard single position upright back lock.
- Optional Forward Tilt: 5° downward from initial position. Only available on chairs with seat depth adjustment.
- Casters: Hard casters in black or two-tone grey; Soft casters black only.
- COM yardage/COL square footage:  
Seat: 0.75/7  
Back: 1.25/12

### Specification Tips

- Ships standard assembled. Optional knocked down shipment comes in three pieces; assembly does not require tools.
- Lumbar color defaults based on chair attributes and is available in Black or Fog only.  
–Black will be received if Carbon knit is ordered or plastic trim color is Black.  
–Fog will be received if Fog or Snow plastic trim is ordered and knit is not Carbon.
- Reference color chart for applied backing material for upholstered or cleanable upholstery back.

### To Order, Specify:

1) Product number, including;

#### 1 Seat Upholstery:

- 1 Leather
- 2 Fabric
- 3 Faux Leather

#### 2 Back Upholstery:

- 0 Knit
- 1 Leather
- 2 Fabric
- 3 Faux Leather

#### 3 Caster Option: Standard Base

- 1 Std. Base Hard Casters (Black)
- 2 Std. Base Soft Casters (Black), add \$57.29 to list
- T Std. Base Hard Two-Tone Casters (Grey)

### Low Base

- 3 Low Base, Hard Casters (Black)
- 4 Low Base, Soft Casters (Black), add \$57.29 to list

2) Seat surface material and color.

3) Back surface material and color.

4) Plastic trim color (frame and arm uprights).  
TR-F Black  
TR-7 Fog, add \$92.13 list.  
TR-UFM Snow, add \$148.82 list.

5) Base color.  
TR-F Black  
TR-LE Metallic Silver  
PM-P Polished Aluminum, add \$135.06 list.

Plastic Trim Color	Lumbar	Arm Caps	Backing Material for Upholstered Back
TR-F Black	TR-F Black	TR-F Black	Tellure, Black 3A-18
TR-7 Fog	TR-7 Fog*	TR-7 Fog	Tellure, Goose 3A-54
TR-UFM Snow	TR-7 Fog*	TR-7 Fog	Tellure, Goose 3A-54

\*If knit is Carbon, lumbar will be Black.

Plastic Trim Color	Lumbar	Arm Caps	Backing Material for Cleanable Upholstered Back
TR-F Black	TR-F Black	TR-F Black	Wellington, Black XJ-BL
TR-7 Fog	TR-7 Fog*	TR-7 Fog	Wellington, Steel XJ-SL
TR-UFM Snow	TR-7 Fog*	TR-7 Fog	Wellington, Steel XJ-SL

\*If knit is Carbon, lumbar will be Black.

Description	Number	Fabric Grade						Leather Grade A	Leather Grade B			
		1	2	3	A	B	C			D	E	F
<b>Knit Back, No Lumbar Adjustment</b>												
Back Lock w/Fixed Seat	SJT- 0-401X	A	\$1054.72	\$1099.34	\$1147.17	\$1169.53	\$1188.64	\$1230.10	\$1268.36	\$1370.39	\$1461.26	\$1660.55
Back Lock w/Seat Depth Adjustment	SJT- 0-401A	A	1083.08	1127.70	1175.53	1197.89	1217.00	1258.46	1296.72	1398.75	1489.62	1688.91
Back Lock & Forward Tilt w/Seat Depth Adjustment	SJT- 0-404A	A	1134.15	1178.77	1226.60	1248.96	1268.07	1309.53	1347.79	1449.82	1540.69	1739.98
<b>Upholstered Back, No Lumbar Adjustment</b>												
Back Lock w/Fixed Seat	SJT- -401X	A	\$1203.30	\$1292.54	\$1388.20	\$1432.92	\$1471.14	\$1554.06	\$1630.58	\$1834.64	\$2016.38	\$2414.96
Back Lock w/Seat Depth Adjustment	SJT- -401A	A	1231.66	1320.90	1416.56	1461.28	1499.50	1582.42	1658.94	1863.00	2044.74	2443.32
Back Lock & Forward Tilt w/Seat Depth Adjustment	SJT- -404A	A	1282.73	1371.97	1467.63	1512.35	1550.57	1633.49	1710.01	1914.07	2095.81	2494.39
<b>Knit Back, Lumbar Adjustment</b>												
Back Lock w/Fixed Seat	SJT- 0-411X	A	\$1122.75	\$1167.37	\$1215.20	\$1237.56	\$1256.67	\$1298.13	\$1336.39	\$1438.42	\$1529.29	\$1728.58
Back Lock w/Seat Depth Adjustment	SJT- 0-411A	A	1151.11	1195.73	1243.56	1265.92	1285.03	1326.49	1364.75	1466.78	1557.65	1756.94
Back Lock & Forward Tilt w/Seat Depth Adjustment	SJT- 0-414A	A	1202.18	1246.80	1294.63	1316.99	1336.10	1377.56	1415.82	1517.85	1608.72	1808.01
<b>Upholstered Back, Lumbar Adjustment</b>												
Back Lock w/Fixed Seat	SJT- -411X	A	\$1271.33	\$1360.57	\$1456.23	\$1500.95	\$1539.17	\$1622.09	\$1698.61	\$1902.67	\$2084.41	\$2482.99
Back Lock w/Seat Depth Adjustment	SJT- -411A	A	1299.69	1388.93	1484.59	1529.31	1567.53	1650.45	1726.97	1931.03	2112.77	2511.35
Back Lock & Forward Tilt w/Seat Depth Adjustment	SJT- -414A	A	1350.76	1440.00	1535.66	1580.38	1618.60	1701.52	1778.04	1982.10	2163.84	2562.42

The following options require modification of the product number.

- Knocked Down Shipment
- Stain Repellent (Fabric seat only)
- Fully Cleanable Back

To specify, change the 11th digit from an **A** to **K** and deduct \$42.52 list; **Example:** SJT-20-401X1K

To specify, add **P** to the end of the product number and add \$49.61 list; **Example:** SJT-20-401X1AP

To specify, change the 5th digit to **C** and add \$38.95 list to upholstered back list price; **Example:** SJT-3C-401X1A

**Note:** Inner back must be Faux Leather to have a fully cleanable back.



SJT-20-111A

**Dimensions**

- \*SH: 16.4"-21.0"  
(417mm-533mm)
- H: 39"-44"  
(991mm-1118mm)
- D: 27"(686mm)
- W: 28"(711mm)
- \*SW: 20"(508mm)
- \*SD: 16.25"-18.75"  
(413mm-476mm)
- \*AH: 9"(229mm)

\* All measurements taken with the BIFMA chair measuring device.

**Features**

- Back: Knit or upholstered.
- Seat: Standard upholstered foam covered in leather, fabric or faux leather. Available as a fixed seat or with seat depth adjustment (2.5"(64mm) range).
- Base: Plastic five-star base.
- Arms: Fixed height.
- Lumbar: Available with optional lumbar support with 3.5"(89mm) adjustment.
- Mechanism: Synchronized tilt; standard tilt tension adjustment.
- Height adjustment: Standard pneumatic.
- Back Lock: Standard single position upright back lock.
- Optional Forward Tilt: 5° downward from initial position. Only available on chairs with seat depth adjustment.
- Casters: Hard casters in black or two-tone grey; Soft casters black only.
- COM yardage/COL square footage:  
Seat: 0.75/7  
Back: 1.25/12

**To Order, Specify:**

1) Product number, including;

**1 Seat Upholstery:**

- 1 Leather
- 2 Fabric
- 3 Faux Leather

**2 Back Upholstery:**

- 0 Knit
- 1 Leather
- 2 Fabric
- 3 Faux Leather

**3 Caster Option:**

- 5 Hard Casters (Black)
- 6 Soft Casters (Black), add \$57.29 to list
- 7 Hard Two-Tone Casters (Grey)

Plastic Trim Color	Lumbar	Arm Caps	Backing Material for Upholstered Back
TR-F Black	TR-F Black	TR-F Black	Tellure, Black 3A-18
TR-7 Fog	TR-7 Fog*	TR-7 Fog	Tellure, Goose 3A-54
TR-UFM Snow	TR-7 Fog*	TR-7 Fog	Tellure, Goose 3A-54

\*If knit is Carbon, lumbar will be Black.

Plastic Trim Color	Lumbar	Arm Caps	Backing Material for Cleanable Upholstered Back
TR-F Black	TR-F Black	TR-F Black	Wellington, Black XJ-BL
TR-7 Fog	TR-7 Fog*	TR-7 Fog	Wellington, Steel XJ-SL
TR-UFM Snow	TR-7 Fog*	TR-7 Fog	Wellington, Steel XJ-SL

\*If knit is Carbon, lumbar will be Black.

**Specification Tips**

- Ships standard assembled. Optional knocked down shipment comes in three pieces; assembly does not require tools.
- Lumbar color defaults based on chair attributes and is available in Black or Fog only.
  - Black will be received if Carbon knit is ordered or plastic trim color is Black.
  - Fog will be received if Fog or Snow plastic trim is ordered and knit is not Carbon.
- Reference color chart for applied backing material for upholstered or cleanable upholstery back.

- 2) Seat surface material and color.
- 3) Back surface material and color.
- 4) Plastic trim color (frame and arm uprights).
  - TR-F Black
  - TR-7 Fog, add \$92.13 list.
  - TR-UFM Snow, add \$148.82 list.
- 5) Base color.
  - TR-F Black
  - TR-7 Fog

Description	Number			Fabric Grade								Leather Grade A	Leather Grade B
	1	2	3	A	B	C	D	E	F	G	H		
<b>Knit Back, No Lumbar Adjustment</b>													
Back Lock w/Fixed Seat	SJT-	0-101X	A	\$ 905.79	\$ 950.41	\$ 998.24	\$1020.60	\$1039.71	\$1081.17	\$1119.43	\$1221.46	\$1312.33	\$1511.62
Back Lock w/Seat Depth Adjustment	SJT-	0-101A	A	934.15	978.77	1026.60	1048.96	1068.07	1109.53	1147.79	1249.82	1340.69	1539.98
Back Lock & Forward Tilt w/Seat Depth Adjustment	SJT-	0-104A	A	985.22	1029.84	1077.67	1100.03	1119.14	1160.60	1198.86	1300.89	1391.76	1591.05
<b>Upholstered Back, No Lumbar Adjustment</b>													
Back Lock w/Fixed Seat	SJT-	-101X	A	\$1054.37	\$1143.61	\$1239.27	\$1283.99	\$1322.21	\$1405.13	\$1481.65	\$1685.71	\$1867.45	\$2266.03
Back Lock w/Seat Depth Adjustment	SJT-	-101A	A	1082.73	1171.97	1267.63	1312.35	1350.57	1433.49	1510.01	1714.07	1895.81	2294.39
Back Lock & Forward Tilt w/Seat Depth Adjustment	SJT-	-104A	A	1133.80	1223.04	1318.70	1363.42	1401.64	1484.56	1561.08	1765.14	1946.88	2345.46
<b>Knit Back, Lumbar Adjustment</b>													
Back Lock w/Fixed Seat	SJT-	0-111X	A	\$ 973.82	\$1018.44	\$1066.27	\$1088.63	\$1107.74	\$1149.20	\$1187.46	\$1289.49	\$1380.36	\$1579.65
Back Lock w/Seat Depth Adjustment	SJT-	0-111A	A	1002.18	1046.80	1094.63	1116.99	1136.10	1177.56	1215.82	1317.85	1408.72	1608.01
Back Lock & Forward Tilt w/Seat Depth Adjustment	SJT-	0-114A	A	1053.25	1097.87	1145.70	1168.06	1187.17	1228.63	1266.89	1368.92	1459.79	1659.08
<b>Upholstered Back, Lumbar Adjustment</b>													
Back Lock w/Fixed Seat	SJT-	-111X	A	\$1122.40	\$1211.64	\$1307.30	\$1352.02	\$1390.24	\$1473.16	\$1549.68	\$1753.74	\$1935.48	\$2334.06
Back Lock w/Seat Depth Adjustment	SJT-	-111A	A	1150.76	1240.00	1335.66	1380.38	1418.60	1501.52	1578.04	1782.10	1963.84	2362.42
Back Lock & Forward Tilt w/Seat Depth Adjustment	SJT-	-114A	A	1201.83	1291.07	1386.73	1431.45	1469.67	1552.59	1629.11	1833.17	2014.91	2413.49

The following options require modification of the product number.

- Knocked Down Shipment
- Stain Repellent (Fabric seat only)
- Fully Cleanable Back

To specify, change the 11th digit from an **A** to **K** and deduct \$42.52 list; **Example:** SJT-20-101X5K  
 To specify, add **P** to the end of the product number and add \$49.61 list; **Example:** SJT-20-101X5AP  
 To specify, change the 5th digit to **C** and add \$38.95 list to upholstered back list price; **Example:** SJT-3C-101X5A  
**Note:** Inner back must be Faux Leather to have a fully cleanable back.

# Soji

## Task Chair with Fixed Arms — Aluminum Base



SJT-20-111A

### Dimensions

- \*SH: 16.4"-21.0"  
(417mm-533mm)
- H: 39"-44"  
(991mm-1118mm)
- D: 27"(686mm)
- W: 28"(711mm)
- \*SW: 20"(508mm)
- \*SD: 16.25"-18.75"  
(413mm-476mm)
- \*AH: 9"(229mm)

Low position seat height:  
14.75"-17.5"  
(375mm-445mm)

\* All measurements taken with the BIFMA chair measuring device.

### Features

- Back: Knit or upholstered.
- Seat: Standard upholstered foam covered in leather, fabric or faux leather. Available as a fixed seat or with seat depth adjustment (3"(76mm) range).
- Base: Aluminum five-star base.
- Arms: Fixed height.
- Lumbar: Available with optional lumbar support with 3.5"(89mm) adjustment.
- Mechanism: Synchronized tilt; standard tilt tension adjustment.
- Height adjustment: Standard pneumatic.
- Back Lock: Standard single position upright back lock.
- Optional Forward Tilt: 5° downward from initial position. Only available on chairs with seat depth adjustment.
- Casters: Hard casters in black or two-tone grey; Soft casters black only.
- COM yardage/COL square footage:  
Seat: 0.75/7  
Back: 1.25/12

### To Order, Specify:

1) Product number, including;

#### 1 Seat Upholstery:

- 1 Leather
- 2 Fabric
- 3 Faux Leather

#### 2 Back Upholstery:

- 0 Knit
- 1 Leather
- 2 Fabric
- 3 Faux Leather

#### 3 Caster Option: Standard Base

- 1 Std. Base Hard Casters (Black)
- 2 Std. Base Soft Casters (Black), add \$57.29 to list
- T Std. Base Hard Two-Tone Casters (Grey)

#### Low Base

- 3 Low Base, Hard Casters (Black)
- 4 Low Base, Soft Casters (Black), add \$57.29 to list

- 2) Seat surface material and color.
- 3) Back surface material and color.
- 4) Plastic trim color (frame and arm uprights).  
TR-F Black  
TR-7 Fog, add \$92.13 list.  
TR-UFM Snow, add \$148.82 list.
- 5) Base color.  
TR-F Black  
TR-LE Metallic Silver  
PM-P Polished Aluminum, add \$135.06 list.

### Specification Tips

- Ships standard assembled. Optional knocked down shipment comes in three pieces; assembly does not require tools.
- Lumbar color defaults based on chair attributes and is available in Black or Fog only.  
–Black will be received if Carbon knit is ordered or plastic trim color is Black.  
–Fog will be received if Fog or Snow plastic trim is ordered and knit is not Carbon.
- Reference color chart for applied backing material for upholstered or cleanable upholstery back.

Plastic Trim Color	Lumbar	Arm Caps	Backing Material for Upholstered Back
TR-F Black	TR-F Black	TR-F Black	Tellure, Black 3A-18
TR-7 Fog	TR-7 Fog*	TR-7 Fog	Tellure, Goose 3A-54
TR-UFM Snow	TR-7 Fog*	TR-7 Fog	Tellure, Goose 3A-54

\*If knit is Carbon, lumbar will be Black.

Plastic Trim Color	Lumbar	Arm Caps	Backing Material for Cleanable Upholstered Back
TR-F Black	TR-F Black	TR-F Black	Wellington, Black XJ-BL
TR-7 Fog	TR-7 Fog*	TR-7 Fog	Wellington, Steel XJ-SL
TR-UFM Snow	TR-7 Fog*	TR-7 Fog	Wellington, Steel XJ-SL

\*If knit is Carbon, lumbar will be Black.

Description	Number			Fabric Grade						Leather			
	1	2	3	A	B	C	D	E	F	G	H	Grade A	Grade B
<b>Knit Back, No Lumbar Adjustment</b>													
Back Lock w/Fixed Seat	SJT-	0-101X	A	\$ 993.88	\$1038.50	\$1086.33	\$1108.69	\$1127.80	\$1169.26	\$1207.52	\$1309.55	\$1400.42	\$1599.71
Back Lock w/Seat Depth Adjustment	SJT-	0-101A	A	1022.24	1066.86	1114.69	1137.05	1156.16	1197.62	1235.88	1337.91	1428.78	1628.07
Back Lock & Forward Tilt w/Seat Depth Adjustment	SJT-	0-104A	A	1073.31	1117.93	1165.76	1188.12	1207.23	1248.69	1286.95	1388.98	1479.85	1679.14
<b>Upholstered Back, No Lumbar Adjustment</b>													
Back Lock w/Fixed Seat	SJT-	-101X	A	\$1142.46	\$1231.70	\$1327.36	\$1372.08	\$1410.30	\$1493.22	\$1569.74	\$1773.80	\$1955.54	\$2354.12
Back Lock w/Seat Depth Adjustment	SJT-	-101A	A	1170.82	1260.06	1355.72	1400.44	1438.66	1521.58	1598.10	1802.16	1983.90	2382.48
Back Lock & Forward Tilt w/Seat Depth Adjustment	SJT-	-104A	A	1221.89	1311.13	1406.79	1451.51	1489.73	1572.65	1649.17	1853.23	2034.97	2433.55
<b>Knit Back, Lumbar Adjustment</b>													
Back Lock w/Fixed Seat	SJT-	0-111X	A	\$1061.91	\$1106.53	\$1154.36	\$1176.72	\$1195.83	\$1237.29	\$1275.55	\$1377.58	\$1468.45	\$1667.74
Back Lock w/Seat Depth Adjustment	SJT-	0-111A	A	1090.27	1134.89	1182.72	1205.08	1224.19	1265.65	1303.91	1405.94	1496.81	1696.10
Back Lock & Forward Tilt w/Seat Depth Adjustment	SJT-	0-114A	A	1141.34	1185.96	1233.79	1256.15	1275.26	1316.72	1354.98	1457.01	1547.88	1747.17
<b>Upholstered Back, Lumbar Adjustment</b>													
Back Lock w/Fixed Seat	SJT-	-111X	A	\$1210.49	\$1299.73	\$1395.39	\$1440.11	\$1478.33	\$1561.25	\$1637.77	\$1841.83	\$2023.57	\$2422.15
Back Lock w/Seat Depth Adjustment	SJT-	-111A	A	1238.85	1328.09	1423.75	1468.47	1506.69	1589.61	1666.13	1870.19	2051.93	2450.51
Back Lock & Forward Tilt w/Seat Depth Adjustment	SJT-	-114A	A	1289.92	1379.16	1474.82	1519.54	1557.76	1640.68	1717.20	1921.26	2103.00	2501.58

The following options require modification of the product number.

- Knocked Down Shipment
- Stain Repellent (Fabric seat only)
- Fully Cleanable Back

To specify, change the 11th digit from an **A** to **K** and deduct \$42.52 list; **Example:** SJT-20-101X1K

To specify, add **P** to the end of the product number and add \$49.61 list; **Example:** SJT-20-101X1AP

To specify, change the 5th digit to **C** and add \$38.95 list to upholstered back list price; **Example:** SJT-3C-101X1A

**Note:** Inner back must be Faux Leather to have a fully cleanable back.



SJT-20-011A

**Dimensions**

- \*SH: 16.4"-21.0"  
(417mm-533mm)
- H: 39"-44"  
(991mm-1118mm)
- D: 27"(686mm)
- W: 28"(711mm)
- \*SW: 20"(508mm)
- \*SD: 16.25"-18.75"  
(413mm-476mm)

\* All measurements taken with the BIFMA chair measuring device.

**Features**

- Back: Knit or upholstered.
- Seat: Standard upholstered foam covered in leather, fabric or faux leather. Available as a fixed seat or with seat depth adjustment (2.5"(64mm) range).
- Base: Plastic five-star base.
- Lumbar: Available with optional lumbar support with 3.5"(89mm) adjustment.
- Mechanism: Synchronized tilt; standard tilt tension adjustment.
- Height adjustment: Standard pneumatic.
- Back Lock: Standard single position upright back lock.
- Optional Forward Tilt: 5° downward from initial position. Only available on chairs with seat depth adjustment.
- Casters: Hard casters in black or two-tone grey; Soft casters black only.
- COM yardage/COL square footage:  
Seat: 0.75/7  
Back: 1.25/12

**To Order, Specify:**

1) Product number, including;

**1 Seat Upholstery:**

- 1 Leather
- 2 Fabric
- 3 Faux Leather

**2 Back Upholstery:**

- 0 Knit
- 1 Leather
- 2 Fabric
- 3 Faux Leather

**3 Caster Option:**

- 5 Hard Casters (Black)
- 6 Soft Casters (Black), add \$57.29 to list
- 7 Hard Two-Tone Casters (Grey)

- 2) Seat surface material and color.
- 3) Back surface material and color.
- 4) Plastic trim color (frame and arm uprights).  
TR-F Black  
TR-7 Fog, add \$92.13 list.  
TR-UFM Snow, add \$148.82 list.
- 5) Base color.  
TR-F Black  
TR-7 Fog

**Specification Tips**

- Ships standard assembled. Optional knocked down shipment comes in three pieces; assembly does not require tools.
- Lumbar color defaults based on chair attributes and is available in Black or Fog only.  
–Black will be received if Carbon knit is ordered or plastic trim color is Black.  
–Fog will be received if Fog or Snow plastic trim is ordered and knit is not Carbon.
- Reference color chart for applied backing material for upholstered or cleanable upholstery back.

Plastic Trim Color	Lumbar	Arm Caps	Backing Material for Upholstered Back
TR-F Black	TR-F Black	TR-F Black	Tellure, Black 3A-18
TR-7 Fog	TR-7 Fog*	TR-7 Fog	Tellure, Goose 3A-54
TR-UFM Snow	TR-7 Fog*	TR-7 Fog	Tellure, Goose 3A-54

\*If knit is Carbon, lumbar will be Black.

Plastic Trim Color	Lumbar	Arm Caps	Backing Material for Cleanable Upholstered Back
TR-F Black	TR-F Black	TR-F Black	Wellington, Black XJ-BL
TR-7 Fog	TR-7 Fog*	TR-7 Fog	Wellington, Steel XJ-SL
TR-UFM Snow	TR-7 Fog*	TR-7 Fog	Wellington, Steel XJ-SL

\*If knit is Carbon, lumbar will be Black.

Description	Number	①	②	③	Fabric Grade								Leather Grade A	Leather Grade B
					A	B	C	D	E	F	G	H		
<b>Knit Back, No Lumbar Adjustment</b>														
Back Lock w/Fixed Seat	SJT-	0-001X	A		\$ 826.30	\$ 870.92	\$ 918.75	\$ 941.11	\$ 960.22	\$1001.68	\$1039.94	\$1141.97	\$1232.84	\$1432.13
Back Lock w/Seat Depth Adjustment	SJT-	0-001A	A		854.66	899.28	947.11	969.47	988.58	1030.04	1068.30	1170.33	1261.20	1460.49
Back Lock & Forward Tilt w/Seat Depth Adjustment	SJT-	0-004A	A		905.73	950.35	998.18	1020.54	1039.65	1081.11	1119.37	1221.40	1312.27	1511.56
<b>Upholstered Back, No Lumbar Adjustment</b>														
Back Lock w/Fixed Seat	SJT-	0-001X	A		\$ 974.88	\$1064.12	\$1159.78	\$1204.50	\$1242.72	\$1325.64	\$1402.16	\$1606.22	\$1787.96	\$2186.54
Back Lock w/Seat Depth Adjustment	SJT-	0-001A	A		1003.24	1092.48	1188.14	1232.86	1271.08	1354.00	1430.52	1634.58	1816.32	2214.90
Back Lock & Forward Tilt w/Seat Depth Adjustment	SJT-	0-004A	A		1054.31	1143.55	1239.21	1283.93	1322.15	1405.07	1481.59	1685.65	1867.39	2265.97
<b>Knit Back, Lumbar Adjustment</b>														
Back Lock w/Fixed Seat	SJT-	0-011X	A		\$ 894.33	\$ 938.95	\$ 986.78	\$1009.14	\$1028.25	\$1069.71	\$1107.97	\$1210.00	\$1300.87	\$1500.16
Back Lock w/Seat Depth Adjustment	SJT-	0-011A	A		922.69	967.31	1015.14	1037.50	1056.61	1098.07	1136.33	1238.36	1329.23	1528.52
Back Lock & Forward Tilt w/Seat Depth Adjustment	SJT-	0-014A	A		973.76	1018.38	1066.21	1088.57	1107.68	1149.14	1187.40	1289.43	1380.30	1579.59
<b>Upholstered Back, Lumbar Adjustment</b>														
Back Lock w/Fixed Seat	SJT-	0-011X	A		\$1042.91	\$1132.15	\$1227.81	\$1272.53	\$1310.75	\$1393.67	\$1470.19	\$1674.25	\$1855.99	\$2254.57
Back Lock w/Seat Depth Adjustment	SJT-	0-011A	A		1071.27	1160.51	1256.17	1300.89	1339.11	1422.03	1498.55	1702.61	1884.35	2282.93
Back Lock & Forward Tilt w/Seat Depth Adjustment	SJT-	0-014A	A		1122.34	1211.58	1307.24	1351.96	1390.18	1473.10	1549.62	1753.68	1935.42	2334.00

The following options require modification of the product number.

- Knocked Down Shipment To specify, change the 11th digit from an A to K and deduct \$42.52 list; **Example:** SJT-20-001X5K
  - Stain Repellent (Fabric seat only) To specify, add P to the end of the product number and add \$49.61 list; **Example:** SJT-20-001X5AP
  - Fully Cleanable Back To specify, change the 5th digit to C and add \$38.95 list to upholstered back list price; **Example:** SJT-3C-001X5A
- Note:** Inner back must be Faux Leather to have a fully cleanable back.

# Soji

## Task Chair without Arms — Aluminum Base



SJT-20-011A

### Dimensions

- \*SH: 16.4"-21.0"  
(417mm-533mm)
- H: 39"-44"  
(991mm-1118mm)
- D: 27"(686mm)
- W: 28"(711mm)
- \*SW: 20"(508mm)
- \*SD: 16.25"-18.75"  
(413mm-476mm)

Low position seat height:  
14.75"-17.5"  
(375mm-445mm)

\* All measurements taken with the BIFMA chair measuring device.

### Features

- Back: Knit or upholstered.
- Seat: Standard upholstered foam covered in leather, fabric or faux leather. Available as a fixed seat or with seat depth adjustment (2.5"(64mm) range).
- Base: Aluminum five-star base.
- Lumbar: Available with optional lumbar support with 3.5"(89mm) adjustment.
- Mechanism: Synchronized tilt; standard tilt tension adjustment.
- Height adjustment: Standard pneumatic.
- Back Lock: Standard single position upright back lock.
- Optional Forward Tilt: 5° downward from initial position. Only available on chairs with seat depth adjustment.
- Casters: Hard casters in black or two-tone grey; Soft casters black only.
- COM yardage/COL square footage:  
Seat: 0.75/7  
Back: 1.25/12

### Specification Tips

- Ships standard assembled. Optional knocked down shipment comes in three pieces; assembly does not require tools.
- Lumbar color defaults based on chair attributes and is available in Black or Fog only.
  - Black will be received if Carbon knit is ordered or plastic trim color is Black.
  - Fog will be received if Fog or Snow plastic trim is ordered and knit is not Carbon.
- Reference color chart for applied backing material for upholstered or cleanable upholstery back.

### To Order, Specify:

- 1) Product number, including;

#### 1 Seat Upholstery:

- 1 Leather
- 2 Fabric
- 3 Faux Leather

#### 2 Back Upholstery:

- 0 Knit
- 1 Leather
- 2 Fabric
- 3 Faux Leather

#### 3 Caster Option: Standard Base

- 1 Std. Base Hard Casters (Black)
- 2 Std. Base Soft Casters (Black), add \$57.29 to list
- T Std. Base Hard Two-Tone Casters (Grey)

#### Low Base

- 3 Low Base, Hard Casters (Black)
- 4 Low Base, Soft Casters (Black), add \$57.29 to list

- 2) Seat surface material and color.
- 3) Back surface material and color.
- 4) Plastic trim color (frame and arm uprights).
  - TR-F Black
  - TR-7 Fog, add \$92.13 list.
  - TR-UFM Snow, add \$148.82 list.
- 5) Base color.
  - TR-F Black
  - TR-LE Metallic Silver
  - PM-P Polished Aluminum, add \$135.06 list.

Plastic Trim Color	Lumbar	Arm Caps	Backing Material for Upholstered Back
TR-F Black	TR-F Black	TR-F Black	Tellure, Black 3A-18
TR-7 Fog	TR-7 Fog*	TR-7 Fog	Tellure, Goose 3A-54
TR-UFM Snow	TR-7 Fog*	TR-7 Fog	Tellure, Goose 3A-54

\*If knit is Carbon, lumbar will be Black.

Plastic Trim Color	Lumbar	Arm Caps	Backing Material for Cleanable Upholstered Back
TR-F Black	TR-F Black	TR-F Black	Wellington, Black XJ-BL
TR-7 Fog	TR-7 Fog*	TR-7 Fog	Wellington, Steel XJ-SL
TR-UFM Snow	TR-7 Fog*	TR-7 Fog	Wellington, Steel XJ-SL

\*If knit is Carbon, lumbar will be Black.

Description	Number			Fabric Grade						Leather			
	1	2	3	A	B	C	D	E	F	G	H	Grade A	Grade B
<b>Knit Back, No Lumbar Adjustment</b>													
Back Lock w/Fixed Seat	SJT-	0-001X	A	\$ 914.39	\$ 959.01	\$1006.84	\$1029.20	\$1048.31	\$1089.77	\$1128.03	\$1230.06	\$1320.93	\$1520.22
Back Lock w/Seat Depth Adjustment	SJT-	0-001A	A	942.75	987.37	1035.20	1057.56	1076.67	1118.13	1156.39	1258.42	1349.29	1548.58
Back Lock & Forward Tilt w/Seat Depth Adjustment	SJT-	0-004A	A	993.82	1038.44	1086.27	1108.63	1127.74	1169.20	1207.46	1309.49	1400.36	1599.65
<b>Upholstered Back, No Lumbar Adjustment</b>													
Back Lock w/Fixed Seat	SJT-	-001X	A	\$1062.97	\$1152.21	\$1247.87	\$1292.59	\$1330.81	\$1413.73	\$1490.25	\$1694.31	\$1876.05	\$2274.63
Back Lock w/Seat Depth Adjustment	SJT-	-001A	A	1091.33	1180.57	1276.23	1320.95	1359.17	1442.09	1518.61	1722.67	1904.41	2302.99
Back Lock & Forward Tilt w/Seat Depth Adjustment	SJT-	-004A	A	1142.40	1231.64	1327.30	1372.02	1410.24	1493.16	1569.68	1773.74	1955.48	2354.06
<b>Knit Back, Lumbar Adjustment</b>													
Back Lock w/Fixed Seat	SJT-	0-011X	A	\$ 982.42	\$1027.04	\$1074.87	\$1097.23	\$1116.34	\$1157.80	\$1196.06	\$1298.09	\$1388.96	\$1588.25
Back Lock w/Seat Depth Adjustment	SJT-	0-011A	A	1010.78	1055.40	1103.23	1125.59	1144.70	1186.16	1224.42	1326.45	1417.32	1616.61
Back Lock & Forward Tilt w/Seat Depth Adjustment	SJT-	0-014A	A	1061.85	1106.47	1154.30	1176.66	1195.77	1237.23	1275.49	1377.52	1468.39	1667.68
<b>Upholstered Back, Lumbar Adjustment</b>													
Back Lock w/Fixed Seat	SJT-	-011X	A	\$1131.00	\$1220.24	\$1315.90	\$1360.62	\$1398.84	\$1481.76	\$1558.28	\$1762.34	\$1944.08	\$2342.66
Back Lock w/Seat Depth Adjustment	SJT-	-011A	A	1159.36	1248.60	1344.26	1388.98	1427.20	1510.12	1586.64	1790.70	1972.44	2371.02
Back Lock & Forward Tilt w/Seat Depth Adjustment	SJT-	-014A	A	1210.43	1299.67	1395.33	1440.05	1478.27	1561.19	1637.71	1841.77	2023.51	2422.09

The following options require modification of the product number.

- Knocked Down Shipment
- Stain Repellent (Fabric seat only)
- Fully Cleanable Back

To specify, change the 11th digit from an **A** to **K** and deduct \$42.52 list; **Example:** SJT-20-001X1K

To specify, add **P** to the end of the product number and add \$49.61 list; **Example:** SJT-20-001X1AP

To specify, change the 5th digit to **C** and add \$38.95 list to upholstered back list price; **Example:** SJT-3C-001X1A

**Note:** Inner back must be Faux Leather to have a fully cleanable back.



SJTC-701X  
SJTC-701A

**Dimensions**

- \*SH: 22"-29.5"  
(559mm-749mm)
- H: 44.6"-52.5"  
(1133mm-1334mm)
- D: 27"(686mm)
- W: 28"(711mm)
- \*SW: 20"(508mm)
- \*SD: 16.25"-18.75"  
(413mm-476mm)
- \*AH: 7.4"-11.4"  
(188mm-290mm)

\* All measurements taken with the BIFMA chair measuring device.

**Features**

- Back: Knit or upholstered.
- Seat: Standard upholstered foam covered in leather, fabric or faux leather. Available as a fixed seat or with seat depth adjustment (2.5"(64mm) range).
- Base: Plastic five-star base.
- Arms: 4D arms have height adjustment range of 4"(102mm). Arms move front to back, side to side and pivot in and out.
- Lumbar: Available with optional lumbar support with 3.5"(89mm) adjustment.
- Mechanism: Synchronized tilt; standard tilt tension adjustment.
- Height adjustment: Standard pneumatic.
- Back Lock: Standard single position upright back lock.
- Casters: Hard casters in black or two-tone grey; Soft casters black only.
- COM yardage/COL square footage:  
Seat: 0.75/7  
Back: 1.25/12

**To Order, Specify:**

1) Product number, including;

**1 Seat Upholstery:**

- 1 Leather
- 2 Fabric
- 3 Faux Leather

**2 Back Upholstery:**

- 0 Knit
- 1 Leather
- 2 Fabric
- 3 Faux Leather

**3 Caster Option:**

- 5 Hard Casters (Black)
- 6 Soft Casters (Black), add \$57.29 to list
- 7 Hard Two-Tone Casters (Grey)

- 2) Seat surface material and color.
- 3) Back surface material and color.
- 4) Plastic trim color (frame and arm uprights).  
TR-F Black  
TR-7 Fog, add \$92.13 list.  
TR-UFM Snow, add \$148.82 list.
- 5) Base color.  
TR-F Black  
TR-7 Fog

Plastic Trim Color	Lumbar	Arm Caps	Backing Material for Upholstered Back
TR-F Black	TR-F Black	TR-F Black	Tellure, Black 3A-18
TR-7 Fog	TR-7 Fog*	TR-7 Fog	Tellure, Goose 3A-54
TR-UFM Snow	TR-7 Fog*	TR-7 Fog	Tellure, Goose 3A-54

\*If knit is Carbon, lumbar will be Black.

Plastic Trim Color	Lumbar	Arm Caps	Backing Material for Cleanable Upholstered Back
TR-F Black	TR-F Black	TR-F Black	Wellington, Black XJ-BL
TR-7 Fog	TR-7 Fog*	TR-7 Fog	Wellington, Steel XJ-SL
TR-UFM Snow	TR-7 Fog*	TR-7 Fog	Wellington, Steel XJ-SL

\*If knit is Carbon, lumbar will be Black.

**Specification Tips**

- Ships standard assembled.
- Lumbar color defaults based on chair attributes and is available in Black or Fog only.  
–Black will be received if Carbon knit is ordered or plastic trim color is Black.  
–Fog will be received if Fog or Snow plastic trim is ordered and knit is not Carbon.
- Reference color chart for applied backing material for upholstered or cleanable upholstery back.

Description	Number ① ② ③	Fabric Grade								Leather Grade A	Leather Grade B
		A	B	C	D	E	F	G	H		
<b>Knit Back, No Lumbar Adjustment</b>											
Back Lock w/Fixed Seat	SJTC- [ ] 0-701X [ ] A	\$1545.18	\$1589.80	\$1637.63	\$1659.99	\$1679.10	\$1720.56	\$1758.82	\$1860.85	\$1951.72	\$2151.01
Back Lock w/Seat Depth Adjustment	SJTC- [ ] 0-701A [ ] A	1573.54	1618.16	1665.99	1688.35	1707.46	1748.92	1787.18	1889.21	1980.08	2179.37
<b>Upholstered Back, No Lumbar Adjustment</b>											
Back Lock w/Fixed Seat	SJTC- [ ] [ ] -701X [ ] A	\$1693.76	\$1783.00	\$1878.66	\$1923.38	\$1961.60	\$2044.52	\$2121.04	\$2325.10	\$2506.84	\$2905.42
Back Lock w/Seat Depth Adjustment	SJTC- [ ] [ ] -701A [ ] A	1722.12	1811.36	1907.02	1951.74	1989.96	2072.88	2149.40	2353.46	2535.20	2933.78
<b>Knit Back, Lumbar Adjustment</b>											
Back Lock w/Fixed Seat	SJTC- [ ] 0-711X [ ] A	\$1613.21	\$1657.83	\$1705.66	\$1728.02	\$1747.13	\$1788.59	\$1826.85	\$1928.88	\$2019.75	\$2219.04
Back Lock w/Seat Depth Adjustment	SJTC- [ ] 0-711A [ ] A	1641.57	1686.19	1734.02	1756.38	1775.49	1816.95	1855.21	1957.24	2048.11	2247.40
<b>Upholstered Back, Lumbar Adjustment</b>											
Back Lock w/Fixed Seat	SJTC- [ ] [ ] -711X [ ] A	\$1761.79	\$1851.03	\$1946.69	\$1991.41	\$2029.63	\$2112.55	\$2189.07	\$2393.13	\$2574.87	\$2973.45
Back Lock w/Seat Depth Adjustment	SJTC- [ ] [ ] -711A [ ] A	1790.15	1879.39	1975.05	2019.77	2057.99	2140.91	2217.43	2421.49	2603.23	3001.81

The following options require modification of the product number.

- Stain Repellent (Fabric seat only)
- Fully Cleanable Back

To specify, add **P** to the end of the product number and add \$49.61 list; **Example:** SJTC-20-701X5AP  
 To specify, change the 6th digit to **C** and add \$38.95 list to upholstered back list price; **Example:** SJTC-3C-701X5A  
**Note:** Inner back must be Faux Leather to have a fully cleanable back.

# Soji

## Task Stool with 4D Arms — Aluminum Base



SJTC-701X  
SJTC-701A

### Dimensions

- \*SH: 22"-29.5"  
(559mm-749mm)
- H: 44.6"-52.5"  
(1133mm-1334mm)
- D: 27"(686mm)
- W: 28"(711mm)
- \*SW: 20"(508mm)
- \*SD: 16.25"-18.75"  
(413mm-476mm)
- \*AH: 7.4"-11.4"  
(188mm-290mm)

\* All measurements taken with the BIFMA chair measuring device.

### Features

- Back: Knit or upholstered.
- Seat: Standard upholstered foam covered in leather, fabric or faux leather. Available as a fixed seat or with seat depth adjustment (2.5"(64mm) range).
- Base: Aluminum five-star base.
- Arms: 4D arms have height adjustment range of 4"(102mm). Arms move front to back, side to side and pivot in and out.
- Lumbar: Available with optional lumbar support with 3.5"(89mm) adjustment.
- Mechanism: Synchronized tilt; standard tilt tension adjustment.
- Height adjustment: Standard pneumatic.
- Back Lock: Standard single position upright back lock.
- Casters: Hard casters in black or two-tone grey; Soft casters black only.
- COM yardage/COL square footage:  
Seat: 0.75/7  
Back: 1.25/12

### To Order, Specify:

1) Product number, including;

#### 1 Seat Upholstery:

- 1 Leather
- 2 Fabric
- 3 Faux Leather

#### 2 Back Upholstery:

- 0 Knit
- 1 Leather
- 2 Fabric
- 3 Faux Leather

#### 3 Caster Option: Standard Base

- 1 Std. Base Hard Casters (Black)
- 2 Std. Base Soft Casters (Black), add \$57.29 to list
- T Std. Base Hard Two-Tone Casters (Grey)

2) Seat surface material and color.  
3) Back surface material and color.

4) Plastic trim color (frame and arm uprights).  
TR-F Black  
TR-7 Fog, add \$92.13 list.  
TR-UFM Snow, add \$148.82 list.

5) Base color.  
TR-F Black  
TR-LE Metallic Silver  
PM-P Polished Aluminum, add \$135.06 list.

Plastic Trim Color	Lumbar	Arm Caps	Backing Material for Upholstered Back
TR-F Black	TR-F Black	TR-F Black	Tellure, Black 3A-18
TR-7 Fog	TR-7 Fog*	TR-7 Fog	Tellure, Goose 3A-54
TR-UFM Snow	TR-7 Fog*	TR-7 Fog	Tellure, Goose 3A-54

\*If knit is Carbon, lumbar will be Black.

Plastic Trim Color	Lumbar	Arm Caps	Backing Material for Cleanable Upholstered Back
TR-F Black	TR-F Black	TR-F Black	Wellington, Black XJ-BL
TR-7 Fog	TR-7 Fog*	TR-7 Fog	Wellington, Steel XJ-SL
TR-UFM Snow	TR-7 Fog*	TR-7 Fog	Wellington, Steel XJ-SL

\*If knit is Carbon, lumbar will be Black.

### Specification Tips

- Ships standard assembled.
- Lumbar color defaults based on chair attributes and is available in Black or Fog only.  
–Black will be received if Carbon knit is ordered or plastic trim color is Black.  
–Fog will be received if Fog or Snow plastic trim is ordered and knit is not Carbon.
- Reference color chart for applied backing material for upholstered or cleanable upholstery back.

Description	Number			Fabric Grade							Leather Grade A	Leather Grade B	
	1	2	3	A	B	C	D	E	F	G			H
<b>Knit Back, No Lumbar Adjustment</b>													
Back Lock w/Fixed Seat	SJTC-	0-701X	A	\$1633.27	\$1677.89	\$1725.72	\$1748.08	\$1767.19	\$1808.65	\$1846.91	\$1948.94	\$2039.81	\$2239.10
Back Lock w/Seat Depth Adjustment	SJTC-	0-701A	A	1661.63	1706.25	1754.08	1776.44	1795.55	1837.01	1875.27	1977.30	2068.17	2267.46
<b>Upholstered Back, No Lumbar Adjustment</b>													
Back Lock w/Fixed Seat	SJTC-	-701X	A	\$1781.85	\$1871.09	\$1966.75	\$2011.47	\$2049.69	\$2132.61	\$2209.13	\$2413.19	\$2594.93	\$2993.51
Back Lock w/Seat Depth Adjustment	SJTC-	-701A	A	1810.21	1899.45	1995.11	2039.83	2078.05	2160.97	2237.49	2441.55	2623.29	3021.87
<b>Knit Back, Lumbar Adjustment</b>													
Back Lock w/Fixed Seat	SJTC-	0-711X	A	\$1701.30	\$1745.92	\$1793.75	\$1816.11	\$1835.22	\$1876.68	\$1914.94	\$2016.97	\$2107.84	\$2307.13
Back Lock w/Seat Depth Adjustment	SJTC-	0-711A	A	1729.66	1774.28	1822.11	1844.47	1863.58	1905.04	1943.30	2045.33	2136.20	2335.49
<b>Upholstered Back, Lumbar Adjustment</b>													
Back Lock w/Fixed Seat	SJTC-	-711X	A	\$1849.88	\$1939.12	\$2034.78	\$2079.50	\$2117.72	\$2200.64	\$2277.16	\$2481.22	\$2662.96	\$3061.54
Back Lock w/Seat Depth Adjustment	SJTC-	-711A	A	1878.24	1967.48	2063.14	2107.86	2146.08	2229.00	2305.52	2509.58	2691.32	3089.90

The following options require modification of the product number.

- Stain Repellent (Fabric seat only)
- Fully Cleanable Back

To specify, add **P** to the end of the product number and add \$49.61 list; **Example:** SJTC-20-701X1AP

To specify, change the 6th digit to **C** and add \$38.95 list to upholstered back list price; **Example:** SJTC-3C-701X1A

**Note:** Inner back must be Faux Leather to have a fully cleanable back.





SJTC-401X  
SJTC-401A

**Dimensions**

- \*SH: 22"-29.5"  
(559mm-749mm)
- H: 44.6"-52.5"  
(1133mm-1334mm)
- D: 27"(686mm)
- W: 28"(711mm)
- \*SW: 20"(508mm)
- \*SD: 16.25"-18.75"  
(413mm-476mm)
- \*AH: 7.4"-11.4"  
(188mm-290mm)

\* All measurements taken with the BIFMA chair measuring device.

**Features**

- Back: Knit or upholstered.
- Seat: Standard upholstered foam covered in leather, fabric or faux leather. Available as a fixed seat or with seat depth adjustment (2.5"(64mm) range).
- Base: Plastic five-star base.
- Arms: Height adjustable with 4"(102mm) range.
- Lumbar: Available with optional lumbar support with 3.5"(89mm) adjustment.
- Mechanism: Synchronized tilt; standard tilt tension adjustment.
- Height adjustment: Standard pneumatic.
- Back Lock: Standard single position upright back lock.
- Casters: Hard casters in black or two-tone grey; Soft casters black only.
- COM yardage/COL square footage:  
Seat: 0.75/7  
Back: 1.25/12

**Specification Tips**

- Ships standard assembled.
- Lumbar color defaults based on chair attributes and is available in Black or Fog only.  
–Black will be received if Carbon knit is ordered or plastic trim color is Black.  
–Fog will be received if Fog or Snow plastic trim is ordered and knit is not Carbon.
- Reference color chart for applied backing material for upholstered or cleanable upholstery back.

**To Order, Specify:**

1) Product number, including;

**1 Seat Upholstery:**

- 1 Leather
- 2 Fabric
- 3 Faux Leather

**2 Back Upholstery:**

- 0 Knit
- 1 Leather
- 2 Fabric
- 3 Faux Leather

**3 Caster Option:**

- 5 Hard Casters (Black)
- 6 Soft Casters (Black), add \$57.29 to list
- 7 Hard Two-Tone Casters (Grey)

- 2) Seat surface material and color.
- 3) Back surface material and color.
- 4) Plastic trim color (frame and arm uprights).  
TR-F Black  
TR-7 Fog, add \$92.13 list.  
TR-UFM Snow, add \$148.82 list.
- 5) Base color.  
TR-F Black  
TR-7 Fog

Plastic Trim Color	Lumbar	Arm Caps	Backing Material for Upholstered Back
TR-F Black	TR-F Black	TR-F Black	Tellure, Black 3A-18
TR-7 Fog	TR-7 Fog*	TR-7 Fog	Tellure, Goose 3A-54
TR-UFM Snow	TR-7 Fog*	TR-7 Fog	Tellure, Goose 3A-54

\*If knit is Carbon, lumbar will be Black.

Plastic Trim Color	Lumbar	Arm Caps	Backing Material for Cleanable Upholstered Back
TR-F Black	TR-F Black	TR-F Black	Wellington, Black XJ-BL
TR-7 Fog	TR-7 Fog*	TR-7 Fog	Wellington, Steel XJ-SL
TR-UFM Snow	TR-7 Fog*	TR-7 Fog	Wellington, Steel XJ-SL

\*If knit is Carbon, lumbar will be Black.

Description	Number ① ② ③	Fabric Grade								Leather Grade A	Leather Grade B	
		A	B	C	D	E	F	G	H			
<b>Knit Back, No Lumbar Adjustment</b>												
Back Lock w/Fixed Seat	SJTC- [ ] 0-401X [ ] A	\$1518.58	\$1563.20	\$1611.03	\$1633.39	\$1652.50	\$1693.96	\$1732.22	\$1834.25	\$1925.12	\$2124.41	
Back Lock w/Seat Depth Adjustment	SJTC- [ ] 0-401A [ ] A	\$1546.94	\$1591.56	\$1639.39	\$1661.75	\$1680.86	\$1722.32	\$1760.58	\$1862.61	\$1953.48	\$2152.77	
<b>Upholstered Back, No Lumbar Adjustment</b>												
Back Lock w/Fixed Seat	SJTC- [ ] [ ] -401X [ ] A	\$1667.16	\$1756.40	\$1852.06	\$1896.78	\$1935.00	\$2017.92	\$2094.44	\$2298.50	\$2480.24	\$2878.82	
Back Lock w/Seat Depth Adjustment	SJTC- [ ] [ ] -401A [ ] A	\$1695.52	\$1784.76	\$1880.42	\$1925.14	\$1963.36	\$2046.28	\$2122.80	\$2326.86	\$2508.60	\$2907.18	
<b>Knit Back, Lumbar Adjustment</b>												
Back Lock w/Fixed Seat	SJTC- [ ] 0-411X [ ] A	\$1586.61	\$1631.23	\$1679.06	\$1701.42	\$1720.53	\$1761.99	\$1800.25	\$1902.28	\$1993.15	\$2192.44	
Back Lock w/Seat Depth Adjustment	SJTC- [ ] 0-411A [ ] A	\$1614.97	\$1659.59	\$1707.42	\$1729.78	\$1748.89	\$1790.35	\$1828.61	\$1930.64	\$2021.51	\$2220.80	
<b>Upholstered Back, Lumbar Adjustment</b>												
Back Lock w/Fixed Seat	SJTC- [ ] [ ] -411X [ ] A	\$1735.19	\$1824.43	\$1920.09	\$1964.81	\$2003.03	\$2085.95	\$2162.47	\$2366.53	\$2548.27	\$2946.85	
Back Lock w/Seat Depth Adjustment	SJTC- [ ] [ ] -411A [ ] A	\$1763.55	\$1852.79	\$1948.45	\$1993.17	\$2031.39	\$2114.31	\$2190.83	\$2394.89	\$2576.63	\$2975.21	

The following options require modification of the product number.

- Stain Repellent (Fabric seat only)
- Fully Cleanable Back

To specify, add **P** to the end of the product number and add \$49.61 list; **Example:** SJTC-20-401X5AP  
 To specify, change the 6th digit to **C** and add \$38.95 list to upholstered back list price; **Example:** SJTC-3C-401X5A  
**Note:** Inner back must be Faux Leather to have a fully cleanable back.

# Soji

## Task Stool with Height Adjustable Arms — Aluminum Base



SJTC-401X  
SJTC-401A

### Dimensions

- \*SH: 22"-29.5"  
(559mm-749mm)
- H: 44.6"-52.5"  
(1133mm-1334mm)
- D: 27"(686mm)
- W: 28"(711mm)
- \*SW: 20"(508mm)
- \*SD: 16.25"-18.75"  
(413mm-476mm)
- \*AH: 7.4"-11.4"  
(188mm-290mm)

\* All measurements taken with the BIFMA chair measuring device.

### Features

- Back: Knit or upholstered.
- Seat: Standard upholstered foam covered in leather, fabric or faux leather. Available as a fixed seat or with seat depth adjustment (2.5"(64mm) range).
- Base: Aluminum five-star base.
- Arms: Height adjustable with 4"(102mm) range.
- Lumbar: Available with optional lumbar support with 3.5"(89mm) adjustment.
- Mechanism: Synchronized tilt; standard tilt tension adjustment.
- Height adjustment: Standard pneumatic.
- Back Lock: Standard single position upright back lock.
- Casters: Hard casters in black or two-tone grey; Soft casters black only.
- COM yardage/COL square footage:  
Seat: 0.75/7  
Back: 1.25/12

### Specification Tips

- Ships standard assembled.
- Lumbar color defaults based on chair attributes and is available in Black or Fog only.  
–Black will be received if Carbon knit is ordered or plastic trim color is Black.  
–Fog will be received if Fog or Snow plastic trim is ordered and knit is not Carbon.
- Reference color chart for applied backing material for upholstered or cleanable upholstery back.

### To Order, Specify:

1) Product number, including;

#### 1 Seat Upholstery:

- 1 Leather
- 2 Fabric
- 3 Faux Leather

#### 2 Back Upholstery:

- 0 Knit
- 1 Leather
- 2 Fabric
- 3 Faux Leather

#### 3 Caster Option: Standard Base

- 1 Std. Base Hard Casters (Black)
- 2 Std. Base Soft Casters (Black), add \$57.29 to list
- T Std. Base Hard Two-Tone Casters (Grey)

2) Seat surface material and color.  
3) Back surface material and color.

4) Plastic trim color (frame and arm uprights).  
TR-F Black  
TR-7 Fog, add \$92.13 list.  
TR-UFM Snow, add \$148.82 list.

5) Base color.  
TR-F Black  
TR-LE Metallic Silver  
PM-P Polished Aluminum, add \$135.06 list.

Plastic Trim Color	Lumbar	Arm Caps	Backing Material for Upholstered Back
TR-F Black	TR-F Black	TR-F Black	Tellure, Black 3A-18
TR-7 Fog	TR-7 Fog*	TR-7 Fog	Tellure, Goose 3A-54
TR-UFM Snow	TR-7 Fog*	TR-7 Fog	Tellure, Goose 3A-54

\*If knit is Carbon, lumbar will be Black.

Plastic Trim Color	Lumbar	Arm Caps	Backing Material for Cleanable Upholstered Back
TR-F Black	TR-F Black	TR-F Black	Wellington, Black XJ-BL
TR-7 Fog	TR-7 Fog*	TR-7 Fog	Wellington, Steel XJ-SL
TR-UFM Snow	TR-7 Fog*	TR-7 Fog	Wellington, Steel XJ-SL

\*If knit is Carbon, lumbar will be Black.

Description	Number			Fabric Grade								Leather Grade A	Leather Grade B
	1	2	3	A	B	C	D	E	F	G	H		
<b>Knit Back, No Lumbar Adjustment</b>													
Back Lock w/Fixed Seat	SJTC-	0-401X	A	\$1606.67	\$1651.29	\$1699.12	\$1721.48	\$1740.59	\$1782.05	\$1820.31	\$1922.34	\$2013.21	\$2212.50
Back Lock w/Seat Depth Adjustment	SJTC-	0-401A	A	1635.03	1679.65	1727.48	1749.84	1768.95	1810.41	1848.67	1950.70	2041.57	2240.86
<b>Upholstered Back, No Lumbar Adjustment</b>													
Back Lock w/Fixed Seat	SJTC-	-401X	A	\$1755.25	\$1844.49	\$1940.15	\$1984.87	\$2023.09	\$2106.01	\$2182.53	\$2386.59	\$2568.33	\$2966.91
Back Lock w/Seat Depth Adjustment	SJTC-	-401A	A	1783.61	1872.85	1968.51	2013.23	2051.45	2134.37	2210.89	2414.95	2596.69	2995.27
<b>Knit Back, Lumbar Adjustment</b>													
Back Lock w/Fixed Seat	SJTC-	0-411X	A	\$1674.70	\$1719.32	\$1767.15	\$1789.51	\$1808.62	\$1850.08	\$1888.34	\$1990.37	\$2081.24	\$2280.53
Back Lock w/Seat Depth Adjustment	SJTC-	0-411A	A	1703.06	1747.68	1795.51	1817.87	1836.98	1878.44	1916.70	2018.73	2109.60	2308.89
<b>Upholstered Back, Lumbar Adjustment</b>													
Back Lock w/Fixed Seat	SJTC-	-411X	A	\$1823.28	\$1912.52	\$2008.18	\$2052.90	\$2091.12	\$2174.04	\$2250.56	\$2454.62	\$2636.36	\$3034.94
Back Lock w/Seat Depth Adjustment	SJTC-	-411A	A	1851.64	1940.88	2036.54	2081.26	2119.48	2202.40	2278.92	2482.98	2664.72	3063.30

The following options require modification of the product number.

- Stain Repellent (Fabric seat only)
- Fully Cleanable Back

To specify, add **P** to the end of the product number and add \$49.61 list; **Example:** SJTC-20-401X1AP

To specify, change the 6th digit to **C** and add \$38.95 list to upholstered back list price; **Example:** SJTC-3C-401X1A

**Note:** Inner back must be Faux Leather to have a fully cleanable back.



SJTC-101X  
SJTC-101A

**Dimensions**

- \*SH: 22"-29.5"  
(559mm-749mm)
- H: 44.6"-52.5"  
(1133mm-1334mm)
- D: 27"(686mm)
- W: 28"(711mm)
- \*SW: 20"(508mm)
- \*SD: 16.25"-18.75"  
(413mm-476mm)
- \*AH: 9"(229mm)

\* All measurements taken with the BIFMA chair measuring device.

**Features**

- Back: Knit or upholstered.
- Seat: Standard upholstered foam covered in leather, fabric or faux leather. Available as a fixed seat or with seat depth adjustment (2.5"(64mm) range).
- Base: Plastic five-star base.
- Arms: Fixed height.
- Lumbar: Available with optional lumbar support with 3.5"(89mm) adjustment.
- Mechanism: Synchronized tilt; standard tilt tension adjustment.
- Height adjustment: Standard pneumatic.
- Back Lock: Standard single position upright back lock.
- Casters: Hard casters in black or two-tone grey; Soft casters black only.
- COM yardage/COL square footage:  
Seat: 0.75/7  
Back: 1.25/12

**Specification Tips**

- Ships standard assembled.
- Lumbar color defaults based on chair attributes and is available in Black or Fog only.  
–Black will be received if Carbon knit is ordered or plastic trim color is Black.  
–Fog will be received if Fog or Snow plastic trim is ordered and knit is not Carbon.
- Reference color chart for applied backing material for upholstered or cleanable upholstery back.

**To Order, Specify:**

1) Product number, including;

**1 Seat Upholstery:**

- 1 Leather
- 2 Fabric
- 3 Faux Leather

**2 Back Upholstery:**

- 0 Knit
- 1 Leather
- 2 Fabric
- 3 Faux Leather

**3 Caster Option:**

- 5 Hard Casters (Black)
- 6 Soft Casters (Black), add \$57.29 to list
- 7 Hard Two-Tone Casters (Grey)

- 2) Seat surface material and color.
- 3) Back surface material and color.
- 4) Plastic trim color (frame and arm uprights).  
TR-F Black  
TR-7 Fog, add \$92.13 list.  
TR-UFM Snow, add \$148.82 list.
- 5) Base color.  
TR-F Black  
TR-7 Fog

Plastic Trim Color	Lumbar	Arm Caps	Backing Material for Upholstered Back
TR-F Black	TR-F Black	TR-F Black	Tellure, Black 3A-18
TR-7 Fog	TR-7 Fog*	TR-7 Fog	Tellure, Goose 3A-54
TR-UFM Snow	TR-7 Fog*	TR-7 Fog	Tellure, Goose 3A-54

\*If knit is Carbon, lumbar will be Black.

Plastic Trim Color	Lumbar	Arm Caps	Backing Material for Cleanable Upholstered Back
TR-F Black	TR-F Black	TR-F Black	Wellington, Black XJ-BL
TR-7 Fog	TR-7 Fog*	TR-7 Fog	Wellington, Steel XJ-SL
TR-UFM Snow	TR-7 Fog*	TR-7 Fog	Wellington, Steel XJ-SL

\*If knit is Carbon, lumbar will be Black.

Description	Number	Fabric Grade									Leather Grade A	Leather Grade B
			1	2	3	A	B	C	D	E		
<b>Knit Back, No Lumbar Adjustment</b>												
Back Lock w/Fixed Seat	SJTC- 0-101X A		\$1457.74	\$1502.36	\$1550.19	\$1572.55	\$1591.66	\$1633.12	\$1671.38	\$1773.41	\$1864.28	\$2063.57
Back Lock w/Seat Depth Adjustment	SJTC- 0-101A A		1486.10	1530.72	1578.55	1600.91	1620.02	1661.48	1699.74	1801.77	1892.64	2091.93
<b>Upholstered Back, No Lumbar Adjustment</b>												
Back Lock w/Fixed Seat	SJTC- -101X A		\$1606.32	\$1695.56	\$1791.22	\$1835.94	\$1874.16	\$1957.08	\$2033.60	\$2237.66	\$2419.40	\$2817.98
Back Lock w/Seat Depth Adjustment	SJTC- -101A A		1634.68	1723.92	1819.58	1864.30	1902.52	1985.44	2061.96	2266.02	2447.76	2846.34
<b>Knit Back, Lumbar Adjustment</b>												
Back Lock w/Fixed Seat	SJTC- 0-111X A		\$1525.77	\$1570.39	\$1618.22	\$1640.58	\$1659.69	\$1701.15	\$1739.41	\$1841.44	\$1932.31	\$2131.60
Back Lock w/Seat Depth Adjustment	SJTC- 0-111A A		1554.13	1598.75	1646.58	1668.94	1688.05	1729.51	1767.77	1869.80	1960.67	2159.96
<b>Upholstered Back, Lumbar Adjustment</b>												
Back Lock w/Fixed Seat	SJTC- -111X A		\$1674.35	\$1763.59	\$1859.25	\$1903.97	\$1942.19	\$2025.11	\$2101.63	\$2305.69	\$2487.43	\$2886.01
Back Lock w/Seat Depth Adjustment	SJTC- -111A A		1702.71	1791.95	1887.61	1932.33	1970.55	2053.47	2129.99	2334.05	2515.79	2914.37

The following options require modification of the product number.

- Stain Repellent (Fabric seat only)
- Fully Cleanable Back

To specify, add **P** to the end of the product number and add \$49.61 list; **Example:** SJTC-20-101X5AP  
 To specify, change the 6th digit to **C** and add \$38.95 list to upholstered back list price; **Example:** SJTC-3C-101X5A  
**Note:** Inner back must be Faux Leather to have a fully cleanable back.

# Soji

## Task Stool with Fixed Arms — Aluminum Base



SJTC-101X  
SJTC-101A

### Dimensions

- \*SH: 22"-29.5"  
(559mm-749mm)
- H: 44.6"-52.5"  
(1133mm-1334mm)
- D: 27"(686mm)
- W: 28"(711mm)
- \*SW: 20"(508mm)
- \*SD: 16.25"-18.75"  
(413mm-476mm)
- \*AH: 9"(229mm)

\* All measurements taken with the BIFMA chair measuring device.

### Features

- Back: Knit or upholstered.
- Seat: Standard upholstered foam covered in leather, fabric or faux leather. Available as a fixed seat or with seat depth adjustment (3"(76mm) range).
- Base: Aluminum five-star base.
- Arms: Fixed height.
- Lumbar: Available with optional lumbar support with 3.5"(89mm) adjustment.
- Mechanism: Synchronized tilt; standard tilt tension adjustment.
- Height adjustment: Standard pneumatic.
- Back Lock: Standard single position upright back lock.
- Casters: Hard casters in black or two-tone grey; Soft casters black only.
- COM yardage/COL square footage:  
Seat: 0.75/7  
Back: 1.25/12

### Specification Tips

- Ships standard assembled.
- Lumbar color defaults based on chair attributes and is available in Black or Fog only.  
–Black will be received if Carbon knit is ordered or plastic trim color is Black.  
–Fog will be received if Fog or Snow plastic trim is ordered and knit is not Carbon.
- Reference color chart for applied backing material for upholstered or cleanable upholstery back.

### To Order, Specify:

1) Product number, including;

#### 1 Seat Upholstery:

- 1 Leather
- 2 Fabric
- 3 Faux Leather

#### 2 Back Upholstery:

- 0 Knit
- 1 Leather
- 2 Fabric
- 3 Faux Leather

#### 3 Caster Option: Standard Base

- 1 Std. Base Hard Casters (Black)
- 2 Std. Base Soft Casters (Black), add \$57.29 to list
- T Std. Base Hard Two-Tone Casters (Grey)

2) Seat surface material and color.  
3) Back surface material and color.

4) Plastic trim color (frame and arm uprights).  
TR-F Black  
TR-7 Fog, add \$92.13 list.  
TR-UFM Snow, add \$148.82 list.

5) Base color.  
TR-F Black  
TR-LE Metallic Silver  
PM-P Polished Aluminum, add \$135.06 list.

Plastic Trim Color	Lumbar	Arm Caps	Backing Material for Upholstered Back
TR-F Black	TR-F Black	TR-F Black	Tellure, Black 3A-18
TR-7 Fog	TR-7 Fog*	TR-7 Fog	Tellure, Goose 3A-54
TR-UFM Snow	TR-7 Fog*	TR-7 Fog	Tellure, Goose 3A-54

\*If knit is Carbon, lumbar will be Black.

Plastic Trim Color	Lumbar	Arm Caps	Backing Material for Cleanable Upholstered Back
TR-F Black	TR-F Black	TR-F Black	Wellington, Black XJ-BL
TR-7 Fog	TR-7 Fog*	TR-7 Fog	Wellington, Steel XJ-SL
TR-UFM Snow	TR-7 Fog*	TR-7 Fog	Wellington, Steel XJ-SL

\*If knit is Carbon, lumbar will be Black.

Description	Number			Fabric Grade								Leather Grade A	Leather Grade B	
	1	2	3	A	B	C	D	E	F	G	H			
<b>Knit Back, No Lumbar Adjustment</b>														
Back Lock w/Fixed Seat	SJTC-	0-	101X	A	\$1545.83	\$1590.45	\$1638.28	\$1660.64	\$1679.75	\$1721.21	\$1759.47	\$1861.50	\$1952.37	\$2151.66
Back Lock w/Seat Depth Adjustment	SJTC-	0-	101A	A	1574.19	1618.81	1666.64	1689.00	1708.11	1749.57	1787.83	1889.86	1980.73	2180.02
<b>Upholstered Back, No Lumbar Adjustment</b>														
Back Lock w/Fixed Seat	SJTC-		-101X	A	\$1694.41	\$1783.65	\$1879.31	\$1924.03	\$1962.25	\$2045.17	\$2121.69	\$2325.75	\$2507.49	\$2906.07
Back Lock w/Seat Depth Adjustment	SJTC-		-101A	A	1722.77	1812.01	1907.67	1952.39	1990.61	2073.53	2150.05	2354.11	2535.85	2934.43
<b>Knit Back, Lumbar Adjustment</b>														
Back Lock w/Fixed Seat	SJTC-	0-	111X	A	\$1613.86	\$1658.48	\$1706.31	\$1728.67	\$1747.78	\$1789.24	\$1827.50	\$1929.53	\$2020.40	\$2219.69
Back Lock w/Seat Depth Adjustment	SJTC-	0-	111A	A	1642.22	1686.84	1734.67	1757.03	1776.14	1817.60	1855.86	1957.89	2048.76	2248.05
<b>Upholstered Back, Lumbar Adjustment</b>														
Back Lock w/Fixed Seat	SJTC-		-111X	A	\$1762.44	\$1851.68	\$1947.34	\$1992.06	\$2030.28	\$2113.20	\$2189.72	\$2393.78	\$2575.52	\$2974.10
Back Lock w/Seat Depth Adjustment	SJTC-		-111A	A	1790.80	1880.04	1975.70	2020.42	2058.64	2141.56	2218.08	2422.14	2603.88	3002.46

The following options require modification of the product number.

- Stain Repellent (Fabric seat only)
- Fully Cleanable Back

To specify, add **P** to the end of the product number and add \$49.61 list; **Example:** SJTC-20-101X1AP

To specify, change the 6th digit to **C** and add \$38.95 list to upholstered back list price; **Example:** SJTC-3C-101X1A

**Note:** Inner back must be Faux Leather to have a fully cleanable back.



SJTC-001X  
SJTC-001A

**Dimensions**

- \*SH: 22"-29.5"  
(559mm-749mm)
- H: 44.6"-52.5"  
(1133mm-1334mm)
- D: 27"(686mm)
- W: 28"(711mm)
- \*SW: 20"(508mm)
- \*SD: 16.25"-18.75"  
(413mm-476mm)

\* All measurements taken with the BIFMA chair measuring device.

**Features**

- Back: Knit or upholstered.
- Seat: Standard upholstered foam covered in leather, fabric or faux leather. Available as a fixed seat or with seat depth adjustment (2.5"(64mm) range).
- Base: Plastic five-star base.
- Lumbar: Available with optional lumbar support with 3.5"(89mm) adjustment.
- Mechanism: Synchronized tilt; standard tilt tension adjustment.
- Height adjustment: Standard pneumatic.
- Back Lock: Standard single position upright back lock.
- Casters: Hard casters in black or two-tone grey; Soft casters black only.
- COM yardage/COL square footage:  
Seat: 0.75/7  
Back: 1.25/12

**To Order, Specify:**

1) Product number, including;

**1 Seat Upholstery:**

- 1 Leather
- 2 Fabric
- 3 Faux Leather

**2 Back Upholstery:**

- 0 Knit
- 1 Leather
- 2 Fabric
- 3 Faux Leather

**3 Caster Option:**

- 5 Hard Casters (Black)
- 6 Soft Casters (Black), add \$57.29 to list
- 7 Hard Two-Tone Casters (Grey)

- 2) Seat surface material and color.
- 3) Back surface material and color.
- 4) Plastic trim color (frame and arm uprights).  
TR-F Black  
TR-7 Fog, add \$92.13 list.  
TR-UFM Snow, add \$148.82 list.
- 5) Base color.  
TR-F Black  
TR-7 Fog

Plastic Trim Color	Lumbar	Arm Caps	Backing Material for Upholstered Back
TR-F Black	TR-F Black	TR-F Black	Tellure, Black 3A-18
TR-7 Fog	TR-7 Fog*	TR-7 Fog	Tellure, Goose 3A-54
TR-UFM Snow	TR-7 Fog*	TR-7 Fog	Tellure, Goose 3A-54

\*If knit is Carbon, lumbar will be Black.

Plastic Trim Color	Lumbar	Arm Caps	Backing Material for Cleanable Upholstered Back
TR-F Black	TR-F Black	TR-F Black	Wellington, Black XJ-BL
TR-7 Fog	TR-7 Fog*	TR-7 Fog	Wellington, Steel XJ-SL
TR-UFM Snow	TR-7 Fog*	TR-7 Fog	Wellington, Steel XJ-SL

\*If knit is Carbon, lumbar will be Black.

**Specification Tips**

- Ships standard assembled.
- Lumbar color defaults based on chair attributes and is available in Black or Fog only.  
–Black will be received if Carbon knit is ordered or plastic trim color is Black.  
–Fog will be received if Fog or Snow plastic trim is ordered and knit is not Carbon.
- Reference color chart for applied backing material for upholstered or cleanable upholstery back.

Description	Number	Fabric Grade									Leather Grade A	Leather Grade B
			1	2	3	A	B	C	D	E		
<b>Knit Back, No Lumbar Adjustment</b>												
Back Lock w/Fixed Seat	SJTC- 0-001X A		\$1378.25	\$1422.87	\$1470.70	\$1493.06	\$1512.17	\$1553.63	\$1591.89	\$1693.92	\$1784.79	\$1984.08
Back Lock w/Seat Depth Adjustment	SJTC- 0-001A A		1406.61	1451.23	1499.06	1521.42	1540.53	1581.99	1620.25	1722.28	1813.15	2012.44
<b>Upholstered Back, No Lumbar Adjustment</b>												
Back Lock w/Fixed Seat	SJTC- -001X A		\$1526.83	\$1616.07	\$1711.73	\$1756.45	\$1794.67	\$1877.59	\$1954.11	\$2158.17	\$2339.91	\$2738.49
Back Lock w/Seat Depth Adjustment	SJTC- -001A A		1555.19	1644.43	1740.09	1784.81	1823.03	1905.95	1982.47	2186.53	2368.27	2766.85
<b>Knit Back, Lumbar Adjustment</b>												
Back Lock w/Fixed Seat	SJTC- 0-011X A		\$1446.28	\$1490.90	\$1538.73	\$1561.09	\$1580.20	\$1621.66	\$1659.92	\$1761.95	\$1852.82	\$2052.11
Back Lock w/Seat Depth Adjustment	SJTC- 0-011A A		1474.64	1519.26	1567.09	1589.45	1608.56	1650.02	1688.28	1790.31	1881.18	2080.47
<b>Upholstered Back, Lumbar Adjustment</b>												
Back Lock w/Fixed Seat	SJTC- -011X A		\$1594.86	\$1684.10	\$1779.76	\$1824.48	\$1862.70	\$1945.62	\$2022.14	\$2226.20	\$2407.94	\$2806.52
Back Lock w/Seat Depth Adjustment	SJTC- -011A A		1623.22	1712.46	1808.12	1852.84	1891.06	1973.98	2050.50	2254.56	2436.30	2834.88

The following options require modification of the product number.

- Stain Repellent (Fabric seat only)
- Fully Cleanable Back

To specify, add **P** to the end of the product number and add \$49.61 list; **Example:** SJTC-20-001X5AP  
 To specify, change the 6th digit to **C** and add \$38.95 list to upholstered back list price; **Example:** SJTC-3C-001X5A  
**Note:** Inner back must be Faux Leather to have a fully cleanable back.

# Soji

## Task Stool without Arms — Aluminum Base



SJTC-001X  
SJTC-001A

### Dimensions

- \*SH: 22"-29.5"  
(559mm-749mm)
- H: 44.6"-52.5"  
(1133mm-1334mm)
- D: 27"(686mm)
- W: 28"(711mm)
- \*SW: 20"(508mm)
- \*SD: 16.25"-18.75"  
(413mm-476mm)

\* All measurements taken with the BIFMA chair measuring device.

### Features

- Back: Knit or upholstered.
- Seat: Standard upholstered foam covered in leather, fabric or faux leather. Available as a fixed seat or with seat depth adjustment (2.5"(64mm) range).
- Base: Aluminum five-star base.
- Lumbar: Available with optional lumbar support with 3.5"(89mm) adjustment.
- Mechanism: Synchronized tilt; standard tilt tension adjustment.
- Height adjustment: Standard pneumatic.
- Seat Lock: Standard single position upright back lock.
- Casters: Hard casters in black or two-tone grey; Soft casters black only.
- COM yardage/COL square footage:  
Seat: 0.75/7  
Back: 1.25/12

### To Order, Specify:

1) Product number, including;

#### 1 Seat Upholstery:

- 1 Leather
- 2 Fabric
- 3 Faux Leather

#### 2 Back Upholstery:

- 0 Knit
- 1 Leather
- 2 Fabric
- 3 Faux Leather

#### 3 Caster Option: Standard Base

- 1 Std. Base Hard Casters (Black)
- 2 Std. Base Soft Casters (Black), add \$57.29 to list
- T Std. Base Hard Two-Tone Casters (Grey)

- 2) Seat surface material and color.
- 3) Back surface material and color.
- 4) Plastic trim color (frame and arm uprights).  
TR-F Black  
TR-7 Fog, add \$92.13 list.  
TR-UFM Snow, add \$148.82 list.
- 5) Base color.  
TR-F Black  
TR-LE Metallic Silver  
PM-P Polished Aluminum, add \$135.06 list.

### Specification Tips

- Ships standard assembled.
- Lumbar color defaults based on chair attributes and is available in Black or Fog only.  
–Black will be received if Carbon knit is ordered or plastic trim color is Black.  
–Fog will be received if Fog or Snow plastic trim is ordered and knit is not Carbon.
- Reference color chart for applied backing material for upholstered or cleanable upholstery back.

Plastic Trim Color	Lumbar	Arm Caps	Backing Material for Upholstered Back
TR-F Black	TR-F Black	TR-F Black	Tellure, Black 3A-18
TR-7 Fog	TR-7 Fog*	TR-7 Fog	Tellure, Goose 3A-54
TR-UFM Snow	TR-7 Fog*	TR-7 Fog	Tellure, Goose 3A-54

\*If knit is Carbon, lumbar will be Black.

Plastic Trim Color	Lumbar	Arm Caps	Backing Material for Cleanable Upholstered Back
TR-F Black	TR-F Black	TR-F Black	Wellington, Black XJ-BL
TR-7 Fog	TR-7 Fog*	TR-7 Fog	Wellington, Steel XJ-SL
TR-UFM Snow	TR-7 Fog*	TR-7 Fog	Wellington, Steel XJ-SL

\*If knit is Carbon, lumbar will be Black.

Description	Number			Fabric Grade								Leather Grade A	Leather Grade B
	1	2	3	A	B	C	D	E	F	G	H		
<b>Knit Back, No Lumbar Adjustment</b>													
Back Lock w/Fixed Seat	SJTC-	0-001X	A	\$1466.34	\$1510.96	\$1558.79	\$1581.15	\$1600.26	\$1641.72	\$1679.98	\$1782.01	\$1872.88	\$2072.17
Back Lock w/Seat Depth Adjustment	SJTC-	0-001A	A	1494.70	1539.32	1587.15	1609.51	1628.62	1670.08	1708.34	1810.37	1901.24	2100.53
<b>Upholstered Back, No Lumbar Adjustment</b>													
Back Lock w/Fixed Seat	SJTC-	-001X	A	\$1614.92	\$1704.16	\$1799.82	\$1844.54	\$1882.76	\$1965.68	\$2042.20	\$2246.26	\$2428.00	\$2826.58
Back Lock w/Seat Depth Adjustment	SJTC-	-001A	A	1643.28	1732.52	1828.18	1872.90	1911.12	1994.04	2070.56	2274.62	2456.36	2854.94
<b>Knit Back, Lumbar Adjustment</b>													
Back Lock w/Fixed Seat	SJTC-	0-011X	A	\$1534.37	\$1578.99	\$1626.82	\$1649.18	\$1668.29	\$1709.75	\$1748.01	\$1850.04	\$1940.91	\$2140.20
Back Lock w/Seat Depth Adjustment	SJTC-	0-011A	A	1562.73	1607.35	1655.18	1677.54	1696.65	1738.11	1776.37	1878.40	1969.27	2168.56
<b>Upholstered Back, Lumbar Adjustment</b>													
Back Lock w/Fixed Seat	SJTC-	-011X	A	\$1682.95	\$1772.19	\$1867.85	\$1912.57	\$1950.79	\$2033.71	\$2110.23	\$2314.29	\$2496.03	\$2894.61
Back Lock w/Seat Depth Adjustment	SJTC-	-011A	A	1711.31	1800.55	1896.21	1940.93	1979.15	2062.07	2138.59	2342.65	2524.39	2922.97

The following options require modification of the product number.

- Stain Repellent (Fabric seat only)
- Fully Cleanable Back

To specify, add **P** to the end of the product number and add \$49.61 list; **Example:** SJTC-20-001X1AP

To specify, change the 6th digit to **C** and add \$38.95 list to upholstered back list price; **Example:** SJTC-3C-001X1A

**Note:** Inner back must be Faux Leather to have a fully cleanable back.

**Veda**  
General Specifications

**Veda by Danielle Gollinucci**

A light-scale, multipurpose chair providing essential comfort across a breadth of applications. Flexible yet supportive - its flawless curvature and minimal mass convey form and function rooted in decades of Italian design heritage.

**General Guidelines for Product Specification**

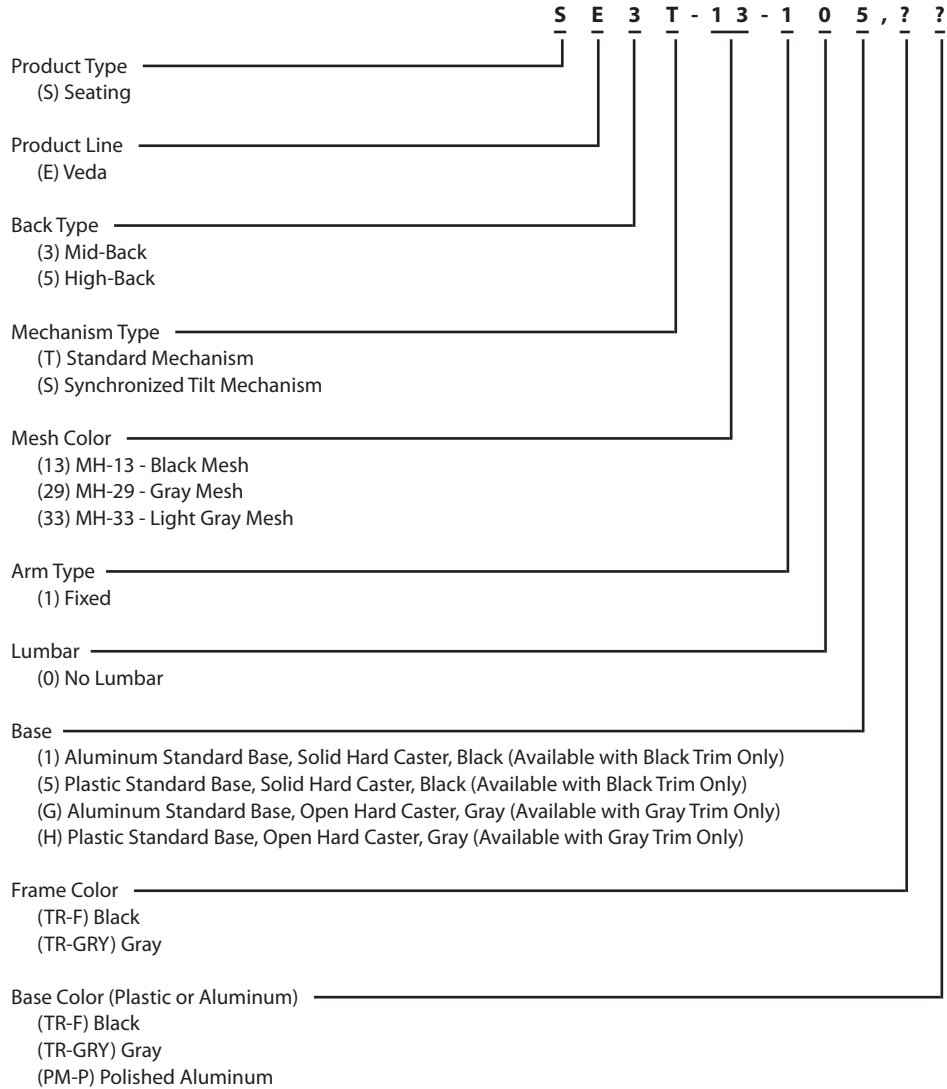

# Veda At-A-Glance

## General Specifications

### Seat Height Adjustment

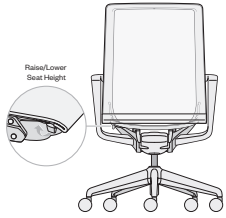
**Features:**

- Pneumatic seat height adjustment.
- Seat height adjusts from 16.7" to 20.9"H(424mm-531mm).

**Benefits:**

- Ensures comfort of lower limbs by avoiding pressure on the underside of the thigh caused by a seat that is too high, or decreased thigh-to-torso angle if the seat is too low.
- Seat height adjustment is important in setting the proper hand position and allowing for proper sitting eye height as well.

### Standard Tilt

**Features:**

- Weight assisted recline mechanism tilts backward 14° from upright position.
- Available on the Mid-Back chair only.

**Benefit:**

- Provides essential comfort without complicated adjustments.

### Synchronized Tilt

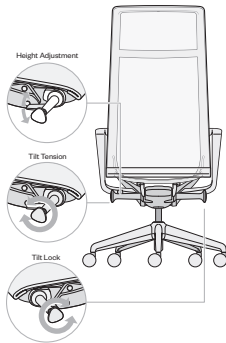
**Features:**

- One piece mesh construction with patented hinge system allows for synchronized recline at a 2:1 ratio.
- Standard with tilt tension adjustment - accommodating full range of tension within one complete revolution.
- Standard with five position tilt lock, four back and one upright position.
- Available on both Mid-Back and High-Back chair.

**Benefits:**

- Comfortable, relaxed posture while keeping your feet on the ground.
- Recline allows for the opening of the user's chest cavity.
- Allows user the opportunity to vary their posture throughout the day.

### Base

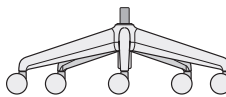
**Features:**

- Plastic or aluminum.
  - Plastic: Black or Gray
  - Aluminum: Polished Aluminum only
- Plastic base color must match frame color.

### Casters

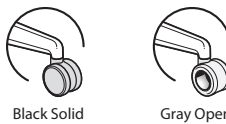
**Features:**

- Hard casters only.
- Caster style and color determined by frame color.
  - Black frame: Black solid casters.
  - Gray frame: Gray open casters.



# Veda

## Mid-Back Chair

### Standard Tilt



SE3T

### Dimensions

\*SH: 16.7"-20.9"  
(424mm-531mm)  
H: 40.3"-44.5"  
(1024mm-1130mm)  
D: 27.5"(699mm)  
W: 27.5"(699mm)  
\*SW: 19.6"(498mm)  
\*SD: 16.8"(427mm)  
\*AH: 8.6"(218mm)

\* Measurements taken with the BIFMA chair measuring device.

### Features

- Back and Seat: One piece mesh construction.
- Black Mesh and Frame.
- Base: Plastic or aluminum five-star base.
  - Plastic base available in Black.
  - Aluminum base available in Polished Aluminum.
- Arms: Fixed height arms.
- Casters: Solid hard casters in black.
- Weight assisted recline mechanism.
- Back tilts backward 14° from upright position.
- COM/COL not available.
- **Ships KD and requires tool-less assembly.**

### To Order, Specify:

- 1) Product number
- 2) Frame color.  
TR-F Black
- 3) Base color.  
Plastic - TR-F Black  
Aluminum - PM-P Polished Aluminum

Description	Number	Price
<b>Plastic Base</b>		
Black Mesh / Black Frame	SE3T-13-105	<b>\$1189.83</b>
<b>Aluminum Base</b>		
Black Mesh / Black Frame	SE3T-13-101	<b>\$1320.65</b>

### Synchronized Tilt



SE3S

### Dimensions

\*SH: 16.7"-20.9"  
(424mm-531mm)  
H: 40.3"-44.5"  
(1024mm-1130mm)  
D: 27.5"(699mm)  
W: 27.5"(699mm)  
\*SW: 19.6"(498mm)  
\*SD: 16.8"(427mm)  
\*AH: 8.6"(218mm)

\* Measurements taken with the BIFMA chair measuring device.

### Features

- Back and Seat: One piece mesh construction.
- Base: Plastic or aluminum five-star base.
  - Plastic base available in black or gray.
  - Aluminum base available in Polished Aluminum.
- Arms: Fixed height arms.
- Mechanism: Synchronized tilt mechanism allows back and seat to adjust in tandem; standard with tilt tension adjustment.
- Back reclines 23.5° from upright position; standard with back lock.
- Frame: Available in Black or Gray Frame.
- Casters: Black frame will have solid hard casters in black. Gray frame will have open hard casters in gray.
- Mesh available in black, gray or light gray.
  - Black mesh available with black frame only.
  - Gray mesh available with black or gray frame.
  - Light gray mesh available with gray frame only.
- COM/COL not available.
- **Ships KD and requires tool-less assembly.**

### To Order, Specify:

- 1) Product number
- 2) Frame color.  
TR-F Black  
TR-GRY Gray
- 3) Base color.  
Plastic - TR-F Black  
TR-GRY Gray  
Aluminum - PM-P Polished Aluminum

**Note:** Plastic base color must match frame color.

Description	Number	Price
<b>Plastic Base</b>		
Black Mesh / Black Frame	SE3S-13-105	<b>\$1339.33</b>
Gray Mesh / Black Frame	SE3S-29-105	<b>1339.33</b>
Gray Mesh / Gray Frame	SE3S-29-10H	<b>\$1488.83</b>
Light Gray Mesh / Gray Frame	SE3S-33-10H	<b>1488.83</b>
<b>Aluminum Base</b>		
Black Mesh / Black Frame	SE3S-13-101	<b>\$1470.15</b>
Gray Mesh / Black Frame	SE3S-29-101	<b>1470.15</b>
Gray Mesh / Gray Frame	SE3S-29-10G	<b>\$1619.65</b>
Light Gray Mesh / Gray Frame	SE3S-33-10G	<b>1619.65</b>

**Veda**

## High-Back Chair

**Synchronized Tilt**

SE55

**Dimensions**

\*SH: 16.7"-20.9"  
(424mm-531mm)  
H: 50.5"-54.7"  
(1283mm-1389mm)  
D: 27.5"(699mm)  
W: 27.5"(699mm)  
\*SW: 19.6"(498mm)  
\*SD: 16.8"(427mm)  
\*AH: 8.6"(218mm)

\* Measurements taken with the BIFMA chair measuring device.

**Features**

- Back and Seat: One piece mesh construction.
- Base: Plastic or aluminum five-star base.
  - Plastic base available in black or gray.
  - Aluminum base available in Polished Aluminum.
- Arms: Fixed height arms.
- Mechanism: Synchronized tilt mechanism allows back and seat to adjust in tandem; standard with tilt tension adjustment.
- Back reclines 23.5° from upright position; standard with back lock.
- Frame: Available in Black or Gray Frame.
- Casters: Black frame will have solid hard casters in black. Gray frame will have open hard casters in gray.
- Mesh available in black, gray or light gray.
  - Black mesh available with black frame only.
  - Gray mesh available with black or gray frame.
  - Light gray mesh available with gray frame only.
- COM/COL not available.
- **Ships KD and requires tool-less assembly.**

**To Order, Specify:**

- 1) Product number
- 2) Frame color.
  - TR-F Black
  - TR-GRY Gray
- 3) Base color.
  - Plastic - TR-F Black
  - TR-GRY Gray
  - Aluminum - PM-P Polished Aluminum

**Note:** Plastic base color must match frame color.

Description	Number	Price
<b>Plastic Base</b>		
Black Mesh / Black Frame	SE55-13-105	<b>\$1495.07</b>
Gray Mesh / Black Frame	SE55-29-105	<b>1495.07</b>
Gray Mesh / Gray Frame	SE55-29-10H	<b>\$1644.57</b>
Light Gray Mesh / Gray Frame	SE55-33-10H	<b>1644.57</b>
<b>Aluminum Base</b>		
Black Mesh / Black Frame	SE55-13-101	<b>\$1625.89</b>
Gray Mesh / Black Frame	SE55-29-101	<b>1625.89</b>
Gray Mesh / Gray Frame	SE55-29-10G	<b>\$1775.39</b>
Light Gray Mesh / Gray Frame	SE55-33-10G	<b>1775.39</b>

# Improv Series

## General Specifications

### Features and Options (Desk Chairs)

Improv Series desk chairs features:

- Molded-polyfoam, contoured seat and back cushions
- Polypropylene or upholstered outer shell
- Optional steel base with plastic cover
- Hard, dual-wheel casters for carpeted floors (black)
- Optional soft, dual-wheel casters for resilient floor surfaces (black)
- Pneumatic height adjustment
- Optional high arc plastic base
- Loop arms, height-adjustable arms or armless
- Standard hard arm caps or upholstered (fabric, leather, or soft black vinyl) arm caps
- Optional two-stage seat height adjustment and low-position seat height adjustment
- Improv does offer stain repellent and moisture barrier on the fully upholstered back chair models.
- Tilt tension

Improv Series desk chairs meet or exceed all ANSI/BIFMA durability standards for office seating.

### Mobility and Adjustability (Task Chairs)

The following features are available on Improv Series desk chair models.



- ▶ Synchronized-tilt (standard)
  - Back and seat recline at a 2:1 ratio with no front seat rise
  - Back tilts backwards 15° from the upright position
  - Seat pan moves downward 7° from the initial position



- ▶ Synchronized-tilt with back-lock
  - Back and seat recline at a 2:1 ratio with no front seat rise
  - Back is lockable in two positions within tilt range
  - Back tilts backwards 15° from the upright position
  - Seat pan moves downward 7° from the initial position
  - Back is lockable in two positions within tilt range, full upright and 5° recline

- ▶ Two-stage seat height adjustment  
HAB or 2 stage seat height  
(14.3"-21.9"(363mm-556mm))

- ▶ Low-position seat height adjustment  
(14"-19"(356mm-483mm))

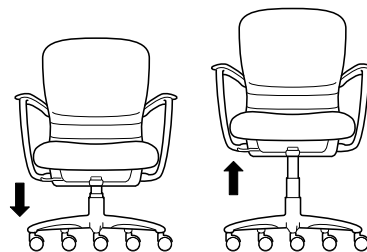

Fully Retracted (.7"(18mm) below standard) Fully Extended (1.9"(48mm) above standard)

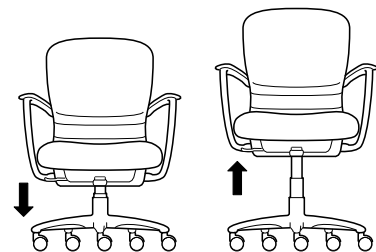

Fully Retracted (1"(25mm) below standard) Fully Extended (1"(25mm) below standard)

- ▶ Optional high arc base

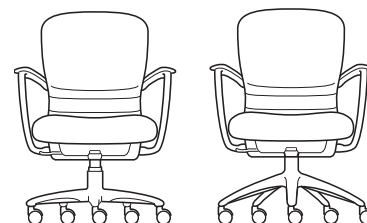

Standard Steel Base High Arc Base  
Standard or High Arc Base seat height  
(15"-20"(381mm-508mm))

# Improv Series

## General Specifications

### Features and Options (Task Seating)

Improv H.E. chairs features:

- Molded-polyfoam, contoured seat and back cushions
- Separate seat and back cushions
- Polypropylene outer shell
- Five-star base with black casters only
- Hard dual-wheel casters (standard) or soft dual-wheel casters (optional)
- Pneumatic seat height adjustment
- Flipper arms, height-adjustable task arms, task arms, 3-D arms or armless
- Optional two-stage seat height adjustment or low-position seat height adjustment
- Optional adjustable air lumbar
- Optional high arc plastic base
- Optional H.E. XL chair for users up to 500 pounds

### Mobility and Adjustability (Task Seating)

The following features are available on Improv H.E. chair models (Refer to price page for specific features).



- Synchronized-tilt (standard)
  - Back and seat recline at a 2:1 ratio with no front seat rise
  - Back tilts backward 20° from the upright position
  - Seat pan moves downward 10° from the initial position

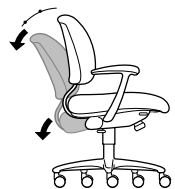

- Synchronized-tilt with back-lock
  - Back and seat recline at a 2:1 ratio with no front seat rise
  - Back is lockable in two positions within tilt range
  - Back tilts backward 20° from the upright position
  - Seat pan moves downward 10° from the initial position



- Forward-tilt
  - Both chair back and seat pan are lockable in three forward positions (1°, 3°, and 5°)

- Adjustable Air Lumbar (H.E. only)
  - Back lumbar has up to 1.5"(38mm) of in/out deflection.

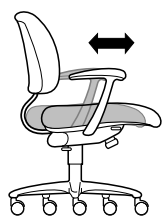

- Seat pan and arms slide horizontally within a 3"(76mm) range

- Two-stage seat height adjustment

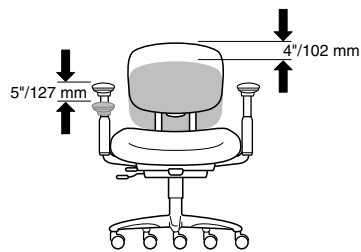

- Back adjusts vertically within a 4"(102mm) range (H.E. only)
- Flipper arms adjust vertically within a 5"(127mm) range

- Low-position seat height adjustment

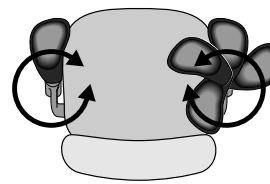

- Flipper arms rotate 360°

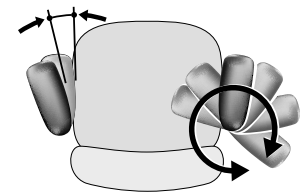

- 3D arms adjust vertically within a 4"(102mm) range and rotate 360°.

- Adjustable Air Lumbar (H.E. only)

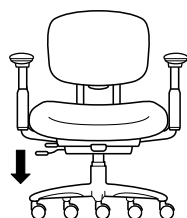

Fully Retracted  
(.7"(18mm) below standard)

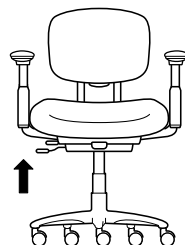

Full Extended  
(1.9"(48mm) above standard)



Fully Retracted  
(1"(25mm) below standard)

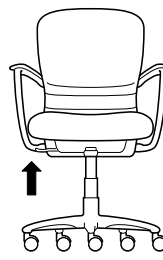

Fully Extended  
(1"(25mm) below standard)



- Back lumbar has up to 1.5"(38mm) of in/out deflection.

**Improv Series**

## General Specifications

**Features and Options  
(Leg-Base and Sled-Base Chairs)**

Improv Series leg-base and sled-base models feature

- 14-gauge elliptical steel tubing legs
- 14-gauge steel side and front stretchers (with arms, tablet and chairs with casters)
- 11-gauge steel front stretchers (without arms)
- Molded polyurethane seat and back foam
- Optional wood back
- Polypropylene or upholstered outer back shell, or full wood back
- High-density polyethylene floor glides (leg-base models)
- Leg base models available with caster option
- Glass-filled nylon sled-base runners with high-density polyethylene floor glides (sled-base models)
- Powder coated frame
- Ganging device option
- Leg-base models with arms stack 6-high (44"(1118mm)) on the floor and 10-high (62"(1575mm)) on the stacking dolly
- Leg-base armless models stack 6-high (44"(1118mm)) on the floor and 10-high (58"(1473mm)) on the stacking dolly
- Leg-base models with casters stack 5-high (42"(1067mm)) on the floor and 6-high (50"(1270mm)) on the stacking dolly
- Wood back model has same stacking capabilities as the leg-base models

Arm chair models feature:

- Glass reinforced polypropylene arms

Armless models feature:

- High-density polyethylene top caps on exposed legs

Tablet arm models feature:

- Right- or left-hand flip-up tablet arm
- 11"(279mm) or 14"(356mm) tablet arms
- Plywood core with high-pressure laminate surface and clear lacquered edge

All Improv table models feature:

- 1"(25mm)-thick particle board core top with laminate or veneer finished surface
- Bullnose PVC or chamfered hardwood edges
- 14-gauge oval steel tube legs
- 0.75"(19mm) diameter steel stretchers
- High-density polyethylene floor glides
- High-density polyethylene leg top caps

Improv series chairs meet or exceed ANSI/BIFMA durability standards for office seating.

# Improv Series

## General Specifications

---

### Shipping Weights (Leg-Base and Sled-Base Chairs)

The following weights include packaging materials

- All leg-base and sled-base chairs 25 lbs. per chair/9.6 cubic ft. (up to 3 chairs per carton)
- 20"(508mm) diameter tables 19 lbs./5.3 cubic ft.
- 24" x 48"(610mm x 1219mm) oval tables 35 lbs./11 cubic ft.
- Chairs without tablet arms are packaged three (3) per carton
- Chairs with tablet arms are packaged two (2) per carton
- Chairs with leather seats are packaged one (1) per carton

NOTE: Models with casters: add one (1) pound per chair

---

### Features and Options (Stools)

All Improv Series stools feature

- 14-gauge elliptical steel tubing legs
  - 14-gauge steel side and front stretchers
  - 14-gauge steel foot rest with lightly textured protective nylon cover
  - Molded polyurethane seat foam, 1.375"(35mm) thick
  - Molded polyurethane back foam, 0.875"(22mm) thick
  - Optional wood back
  - Polypropylene (0.75"(19mm)) or upholstered (1.25"(32mm)) seat and back shell
  - High-density polyethylene floor glides
  - Glass reinforced polypropylene arms or high-density polyethylene top caps on exposed legs
  - Powder coated frame
- 

### Shipping Weights (Stools)

The following weights do not include packaging materials.

Stool with arms: 30 lbs./13.608k

Stool without arms: 27 lbs./12.247k

---

### COM & COL General Information

To order a COM fabric (Customer's Own Material), contact the Haworth Inquiry Center (1.800.426.8562), your local Haworth dealer, or go to [haworth.com/surfaces](http://haworth.com/surfaces) to find out if the COM you have selected has already been tested and approved. The surface collection site also has information on the Haworth alliance program with Carnegie, Luna Textiles, and Maharam as well as our industry-leading Pre-Approved COM program.

COM fabrics are placed into Grades based on the cost per linear yard. If a fabric's cost exceeds the range of our highest Grade it will be noted as Non-Graded. The product will be priced at Grade A; the COM fabric costs will appear as a separate line item. The fabric charge will be Haworth's purchase cost plus a 4% administrative fee (based on the cost of the fabric). Yardage calculations will include any applicable fabric repeat.

COM Leather products will be priced at a leather Grade A; COL costs will appear as a separate line item. The leather costs will be Haworth's purchase cost plus a 4% administrative fee (based on the cost of the leather).

---

### Environmental Factors

#### Material Off Gassing

In an effort to ensure air quality standards, all Improv parts suppliers are required to provide Material Data Sheets and/or other documentation, verifying that their products do not emit volatile organic compounds (VOCs). In addition, the powder-coat paint process used in the manufacturing of Improv seating is free of VOCs. Our manufacturing processes have also eliminated all use of chlorofluorocarbons (CFCs) and ozone depleting chemicals (ODCs) in the chair's construction.

#### Recycling

All fabric scraps are recycled, reducing the amount of material sent to landfills, and all chair components disassemble easily to increase the potential for recycling. In addition, all thermo-plastic parts are 100% reprocessible, and all raw materials used in its manufacturing can be recycled at the end of the useful life of the product. Recyclable parts are identified with the recycle symbol where practical.

# Improv Series

## General Specifications

### General Guidelines for Product Specification

Improv Series seating specification numbers are based on an alpha-numeric logic that identifies a product by model and certain characteristics.

For example, a product number that reads **M221-2241** identifies the product as an Improv high-back chair with seamless upholstered outer shell, pneumatic seat height adjustment, upholstered arms, back-lock, and hard dual-wheel casters.

The alpha-numeric logic for this model complete with fabric and finish codes is shown below:

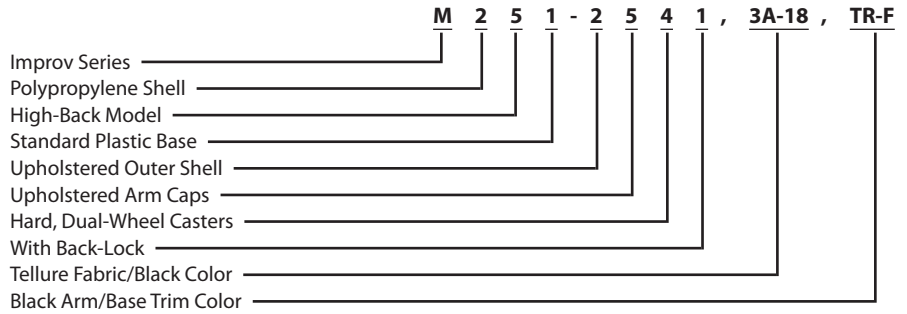

A ninth-digit suffix of the product number will indicate functional option, such as -F for CAL 133 option.

There are exceptions to this logic; therefore, always refer to the price charts for product numbers rather than attempting to construct them. Product number modification instructions for additional options appear in footnoted copy for each applicable model.

Beyond the printed product number, fabric and finish codes are required to complete an order specification. To communicate your order clearly, list the product number and fabric/finish codes in the sequence outlined on each price page.

### Finishes and Fabrics

A complete listing of finishes and fabrics for Improv Series desk chairs can be found in the back of the price list.

# Improv Series

## Improv H.E. XL Chair with Task Arms



M271-1442

### Dimensions

- \*SH: 16" - 20.5"  
(406mm - 521mm)
- H: 36.5" - 45"  
(957mm - 1143mm)
- D: 23.5" - 26.5"  
(597mm - 673mm)
- W: 30"(762mm)
- \*SW: 23.75"(603mm)
- \*SD: 19"(483mm)
- \*AH: 9.6"(244mm)

\* All measurements taken with the BIFMA chair measuring device.

### Features

- Accommodates up to 500 pounds.
- Outer Shells: Polypropylene.
- Arms: Standard, upholstered fabric or soft black vinyl arm caps.
- Casters: Standard with hard casters.
- Mechanism: Swivel with synchronized-tilt.
- Height Adjustment: Pneumatic.
- Optional Back-Lock: Lockable in two positions.
- Optional Forward Tilt: Lockable in 3 positions.
- Tilt tension.
- Optional Adjustable Air Lumbar additional 1.5"(38mm) of lumbar support.
- COM yardage / COL square footage: Polypropylene shell: 2.41/51

### To Order, Specify:

- 1) Product number.
- 2) Fabric surface and color.
- 3) Trim color for shell, arms and base.

Shells	Arms/Caps	Number	Fabric Grade								Leather Grade A	Leather Grade B
			A	B	C	D	E	F	G	H		
<b>Pneumatic Height Adjustment</b>												
Polypropylene	Standard	M271-1442	\$3975.20	\$4112.88	\$4257.14	\$4329.24	\$4392.54	\$4519.40	\$4635.18	\$4956.44	\$5179.28	\$5509.16
	Upholstered	M271-1542	4069.20	4206.88	4351.14	4423.24	4486.54	4613.40	4729.18	5050.44	5273.28	5603.16
	Soft Black Vinyl	M271-1642	4069.20	4206.88	4351.14	4423.24	4486.54	4613.40	4729.18	5050.44	5273.28	5603.16
<b>Pneumatic Height Adjustment/Back-Lock</b>												
Polypropylene	Standard	M271-1441	\$4069.20	\$4206.88	\$4351.14	\$4423.24	\$4486.54	\$4613.40	\$4729.18	\$5050.44	\$5273.28	\$5603.16
	Upholstered	M271-1541	4163.20	4300.88	4445.14	4517.24	4580.54	4707.40	4823.18	5144.44	5367.28	5697.16
	Soft Black Vinyl	M271-1641	4163.20	4300.88	4445.14	4517.24	4580.54	4707.40	4823.18	5144.44	5367.28	5697.16
<b>Pneumatic Height Adjustment/Forward-Tilt</b>												
Polypropylene	Standard	M281-1442	\$4066.97	\$4204.65	\$4348.91	\$4421.01	\$4484.31	\$4611.17	\$4726.95	\$5048.21	\$5271.05	\$5600.93
	Upholstered	M281-1542	4160.97	4298.65	4442.91	4515.01	4578.31	4705.17	4820.95	5142.21	5365.05	5694.93
	Soft Black Vinyl	M281-1642	4160.97	4298.65	4442.91	4515.01	4578.31	4705.17	4820.95	5142.21	5365.05	5694.93
<b>Pneumatic Height Adjustment with Adjustable Air Lumbar</b>												
Polypropylene	Standard	M271-1444	\$4202.49	\$4340.17	\$4484.43	\$4556.53	\$4619.83	\$4746.69	\$4862.47	\$5183.73	\$5406.57	\$5736.45
	Upholstered	M271-1544	4296.49	4434.17	4578.43	4650.53	4713.83	4840.69	4956.47	5277.73	5500.57	5830.45
	Soft Black Vinyl	M271-1644	4296.49	4434.17	4578.43	4650.53	4713.83	4840.69	4956.47	5277.73	5500.57	5830.45
<b>Pneumatic Height Adjustment/Back-Lock with Adjustable Air Lumbar</b>												
Polypropylene	Standard	M271-1443	\$4296.49	\$4434.17	\$4578.43	\$4650.53	\$4713.83	\$4840.69	\$4956.47	\$5277.73	\$5500.57	\$5830.45
	Upholstered	M271-1543	4390.49	4528.17	4672.43	4744.53	4807.83	4934.69	5050.47	5371.73	5594.57	5924.45
	Soft Black Vinyl	M271-1643	4390.49	4528.17	4672.43	4744.53	4807.83	4934.69	5050.47	5371.73	5594.57	5924.45
<b>Pneumatic Height Adjustment/Forward-Tilt with Adjustable Air Lumbar</b>												
Polypropylene	Standard	M281-1444	\$4294.26	\$4431.94	\$4576.20	\$4648.30	\$4711.60	\$4838.46	\$4954.24	\$5275.50	\$5498.34	\$5828.22
	Upholstered	M281-1544	4388.26	4525.94	4670.20	4742.30	4805.60	4932.46	5048.24	5369.50	5592.34	5922.22
	Soft Black Vinyl	M281-1644	4388.26	4525.94	4670.20	4742.30	4805.60	4932.46	5048.24	5369.50	5592.34	5922.22

The following options require modification of the product number.

- Faux Leather upholstery
- Leather upholstery
- Stain repellent

To specify, change the 2nd digit from a 2 to a 3; **Example:** M371-1542

To specify, change the 2nd digit from a 2 to a 1; **Example:** M171-1542

To specify, add -P to the end of the product number; **Example:** M271-1442-P (add \$69.94 list)

**NOTE:** For available fabrics, refer to [surfaces.haworth.com](http://surfaces.haworth.com).



# Improv Series

Improv H.E. XL Chair with Flipper Arms



M271-1H42

### Dimensions

- \*SH: 16" - 20.5"  
(406mm - 521mm)
- H: 36.5" - 45"  
(957mm - 1143mm)
- D: 23.5" - 26.5"  
(597mm - 673mm)
- W: 30"(762mm)
- \*SW: 23.75"(603mm)
- \*SD: 19"(483mm)
- \*AH: 6.2" - 11.1"  
(157mm-282mm)

\* All measurements taken with the BIFMA chair measuring device.

### Features

- Accommodates up to 500 pounds.
- Outer Shells: Polypropylene.
- Arms: Standard, upholstered fabric or black vinyl gel arm caps.
- Arm Adjustment Controls: Fingertip activation.
- Arm Adjustment: 5"(127mm) height adjustment.
- Arm Pad Rotation: 360°
- Casters: Standard with hard casters.
- Mechanism: Swivel with synchronized-tilt.
- Height Adjustment: Pneumatic.
- Optional Back-Lock: Lockable in two positions.
- Optional Forward Tilt: Lockable in 3 positions.
- Tilt tension.
- Optional Adjustable Air Lumbar additional 1.5"(38mm) of lumbar support.
- COM yardage / COL square footage: Polypropylene shell: 2.41/51

### To Order, Specify:

- 1) Product number.
- 2) Fabric surface and color.
- 3) Trim color for shell, arms and base.

Shells	Arms/Caps	Number	Fabric Grade		C	D	E	F	G	H	Leather Grade A	Leather Grade B
			A	B								
<b>Pneumatic Height Adjustment</b>												
Polypropylene	Standard	M271-1H42	\$4574.00	\$4711.68	\$4855.94	\$4928.04	\$4991.34	\$5118.20	\$5233.98	\$5555.24	\$5778.08	\$6107.96
	Vinyl Gel	M271-1G42	4694.20	4831.88	4976.14	5048.24	5111.54	5238.40	5354.18	5675.44	5898.28	6228.16
	Upholstered	M271-1U42	4779.42	4917.10	5061.36	5133.46	5196.76	5323.62	5439.40	5760.66	5983.50	6313.38
<b>Pneumatic Height Adjustment/Back-Lock</b>												
Polypropylene	Standard	M271-1H41	\$4668.00	\$4805.68	\$4949.94	\$5022.04	\$5085.34	\$5212.20	\$5327.98	\$5649.24	\$5872.08	\$6201.96
	Vinyl Gel	M271-1G41	4788.20	4925.88	5070.14	5142.24	5205.54	5332.40	5448.18	5769.44	5992.28	6322.16
	Upholstered	M271-1U41	4873.42	5011.10	5155.36	5227.46	5290.76	5417.62	5533.40	5854.66	6077.50	6407.38
<b>Pneumatic Height Adjustment/Forward-Tilt</b>												
Polypropylene	Standard	M281-1H42	\$4665.77	\$4803.45	\$4947.71	\$5019.81	\$5083.11	\$5209.97	\$5325.75	\$5647.01	\$5869.85	\$6199.73
	Vinyl Gel	M281-1G42	4785.97	4923.65	5067.91	5140.01	5203.31	5330.17	5445.95	5767.21	5990.05	6319.93
	Upholstered	M281-1U42	4871.19	5008.87	5153.13	5225.23	5288.53	5415.39	5531.17	5852.43	6075.27	6405.15
<b>Pneumatic Height Adjustment with Adjustable Air Lumbar</b>												
Polypropylene	Standard	M271-1H44	\$4801.29	\$4938.97	\$5083.23	\$5155.33	\$5218.63	\$5345.49	\$5461.27	\$5782.53	\$6005.37	\$6335.25
	Vinyl Gel	M271-1G44	4921.49	5059.17	5203.43	5275.53	5338.83	5465.69	5581.47	5902.73	6125.57	6455.45
	Upholstered	M271-1U44	5006.71	5144.39	5288.65	5360.75	5424.05	5550.91	5666.69	5987.95	6210.79	6540.67
<b>Pneumatic Height Adjustment/Back-Lock with Adjustable Air Lumbar</b>												
Polypropylene	Standard	M271-1H43	\$4895.29	\$5032.97	\$5177.23	\$5249.33	\$5312.63	\$5439.49	\$5555.27	\$5876.53	\$6099.37	\$6429.25
	Vinyl Gel	M271-1G43	5015.49	5153.17	5297.43	5369.53	5432.83	5559.69	5675.47	5996.73	6219.57	6549.45
	Upholstered	M271-1U43	5100.71	5238.39	5382.65	5454.75	5518.05	5644.91	5760.69	6081.95	6304.79	6634.67
<b>Pneumatic Height Adjustment/Forward-Tilt with Adjustable Air Lumbar</b>												
Polypropylene	Standard	M281-1H44	\$4893.06	\$5030.74	\$5175.00	\$5247.10	\$5310.40	\$5437.26	\$5553.04	\$5874.30	\$6097.14	\$6427.02
	Vinyl Gel	M281-1G44	5013.26	5150.94	5295.20	5367.30	5430.60	5557.46	5673.24	5994.50	6217.34	6547.22
	Upholstered	M281-1U44	5098.48	5236.16	5380.42	5452.52	5515.82	5642.68	5758.46	6079.72	6302.56	6632.44

The following options require modification of the product number.

- Faux Leather upholstery
- Leather upholstery
- Stain repellent

- To specify, change the 2nd digit from a 2 to a 3; **Example:** M371-1H42
- To specify, change the 2nd digit from a 2 to a 1; **Example:** M171-1H42
- To specify, add -P to the end of the product number; **Example:** M271-1H44-P (add \$69.94 list)

**NOTE:** For available fabrics, refer to [surfaces.haworth.com](http://surfaces.haworth.com).

# Improv Series

## Improv H.E. XL Chair without Arms



M271-1042

### Dimensions

- \*SH: 16" - 20.5"  
(406mm - 521mm)
- H: 36.5" - 45"  
(957mm-1143mm)
- D: 23.5" - 26.5"  
(597mm - 673mm)
- W: 30"(762mm)
- \*SW: 23.75"(603mm)
- \*SD: 19"(483mm)

\* All measurements taken with the BIFMA chair measuring device.

### Features

- Accommodates up to 500 pounds.
- Outer Shells: Polypropylene.
- Casters: Standard with hard casters.
- Mechanism: Swivel with synchronized-tilt.
- Height Adjustment: Pneumatic.
- Optional Adjustable Air Lumbar models available: additional 1.5"(38mm) of lumbar support.
- Optional Back-Lock: Lockable in two positions.
- Optional Forward Tilt: Lockable in 3 positions.
- Tilt tension.
- COM yardage / COL square footage: Polypropylene shell: 2.41/51

### To Order, Specify:

- 1) Product number.
- 2) Fabric surface and color.
- 3) Trim color for shell and base.

Shells	Number	Fabric Grade								Leather Grade A	Leather Grade B
		A	B	C	D	E	F	G	H		
<b>Pneumatic Height Adjustment</b>											
Polypropylene	M271-1042	\$3791.61	\$3929.29	\$4073.55	\$4145.65	\$4208.95	\$4335.81	\$4451.59	\$4772.85	\$4995.69	\$5325.57
<b>Pneumatic Height Adjustment/Back-Lock</b>											
Polypropylene	M271-1041	\$3885.61	\$4023.29	\$4167.55	\$4239.65	\$4302.95	\$4429.81	\$4545.59	\$4866.85	\$5089.69	\$5419.57
<b>Pneumatic Height Adjustment/Forward-Tilt</b>											
Polypropylene	M281-1042	\$3883.38	\$4021.06	\$4165.32	\$4237.42	\$4300.72	\$4427.58	\$4543.36	\$4864.62	\$5087.46	\$5417.34
<b>Pneumatic Height Adjustment with Adjustable Air Lumbar</b>											
Polypropylene	M271-1044	\$4018.90	\$4156.58	\$4300.84	\$4372.94	\$4436.24	\$4563.10	\$4678.88	\$5000.14	\$5222.98	\$5552.86
<b>Pneumatic Height Adjustment/Back-Lock with Adjustable Air Lumbar</b>											
Polypropylene	M271-1043	\$4112.90	\$4250.58	\$4394.84	\$4466.94	\$4530.24	\$4657.10	\$4772.88	\$5094.14	\$5316.98	\$5646.86
<b>Pneumatic Height Adjustment/Forward-Tilt with Adjustable Air Lumbar</b>											
Polypropylene	M281-1044	\$4110.67	\$4248.35	\$4392.61	\$4464.71	\$4528.01	\$4654.87	\$4770.65	\$5091.91	\$5314.75	\$5644.63

The following options require modification of the product number.

- Faux Leather upholstery
- Leather upholstery
- Stain repellent

To specify, change the 2nd digit from a 2 to a 3; **Example:** M371-2042

To specify, change the 2nd digit from a 2 to a 1; **Example:** M171-2042

To specify, add -P to the end of the product number; **Example:** M271-1042-P (add \$69.94 list)

**NOTE:** For available fabrics, refer to [surfaces.haworth.com](https://surfaces.haworth.com).

# Improv Series

## Improv H.E. High-Back Chair with Task Arms



M251-1442

### Dimensions

- SH: 16" - 21"  
(406mm-533mm)
- H: 36.5" - 45"  
(957mm - 1143mm)
- D: 24" - 27.25"  
(610mm - 692mm)
- W: 25"(635mm)
- \*SW: 19.2"(488mm)
- \*SD: 16" - 19"  
(406mm - 483mm)
- \*AH: 9.6"(244mm)

\* All measurements taken with the BIFMA chair measuring device.

### Features

- Outer Shells: Polypropylene.
- Arms: Standard, upholstered fabric or soft black vinyl arm caps.
- 3"(76mm) sliding seat pan.
- Casters: Standard with hard casters; or optional soft casters.
- Standard plastic base or optional high arc, or steel base.
- Mechanism: Swivel with synchronized-tilt.
- Height Adjustment: Pneumatic, pneumatic with low-position seat height option.
- Optional Back-Lock: Lockable in two positions.
- Optional Forward Tilt: Lockable in 3 positions.
- Tilt tension.
- Optional Adjustable Air Lumbar: additional 1.5"(38mm) of lumbar support.
- COM yardage / COL square footage: Polypropylene shell: 2.13/45

### To Order, Specify:

- 1) Product number.
- 2) Fabric surface and color.
- 3) Trim color for shell, arms and base.

Shells	Arms/Caps	Number	Fabric Grade		C	D	E	F	G	H	Leather Grade A	Leather Grade B
			A	B								
<b>Pneumatic Height Adjustment</b>												
Polypropylene	Standard	M251-1442	\$1993.06	\$2130.74	\$2275.00	\$2347.10	\$2410.40	\$2537.26	\$2653.04	\$2974.30	\$3197.14	\$3527.02
	Upholstered	M251-1542	2087.06	2224.74	2369.00	2441.10	2504.40	2631.26	2747.04	3068.30	3291.14	3621.02
	Soft Black Vinyl	M251-1642	2087.06	2224.74	2369.00	2441.10	2504.40	2631.26	2747.04	3068.30	3291.14	3621.02
<b>Pneumatic Height Adjustment/Back-Lock</b>												
Polypropylene	Standard	M251-1441	\$2087.06	\$2224.74	\$2369.00	\$2441.10	\$2504.40	\$2631.26	\$2747.04	\$3068.30	\$3291.14	\$3621.02
	Upholstered	M251-1541	2181.06	2318.74	2463.00	2535.10	2598.40	2725.26	2841.04	3162.30	3385.14	3715.02
	Soft Black Vinyl	M251-1641	2181.06	2318.74	2463.00	2535.10	2598.40	2725.26	2841.04	3162.30	3385.14	3715.02
<b>Pneumatic Height Adjustment/Forward-Tilt</b>												
Polypropylene	Standard	M261-1442	\$2084.83	\$2222.51	\$2366.77	\$2438.87	\$2502.17	\$2629.03	\$2744.81	\$3066.07	\$3288.91	\$3618.79
	Upholstered	M261-1542	2178.83	2316.51	2460.77	2532.87	2596.17	2723.03	2838.81	3160.07	3382.91	3712.79
	Soft Black Vinyl	M261-1642	2178.83	2316.51	2460.77	2532.87	2596.17	2723.03	2838.81	3160.07	3382.91	3712.79
<b>Pneumatic Height Adjustment with Adjustable Air Lumbar</b>												
Polypropylene	Standard	M251-1444	\$2220.35	\$2358.03	\$2502.29	\$2574.39	\$2637.69	\$2764.55	\$2880.33	\$3201.59	\$3424.43	\$3754.31
	Upholstered	M251-1544	2314.35	2452.03	2596.29	2668.39	2731.69	2858.55	2974.33	3295.59	3518.43	3848.31
	Soft Black Vinyl	M251-1644	2314.35	2452.03	2596.29	2668.39	2731.69	2858.55	2974.33	3295.59	3518.43	3848.31
<b>Pneumatic Height Adjustment/Back-Lock with Adjustable Air Lumbar</b>												
Polypropylene	Standard	M251-1443	\$2314.35	\$2452.03	\$2596.29	\$2668.39	\$2731.69	\$2858.55	\$2974.33	\$3295.59	\$3518.43	\$3848.31
	Upholstered	M251-1543	2408.35	2546.03	2690.29	2762.39	2825.69	2952.55	3068.33	3389.59	3612.43	3942.31
	Soft Black Vinyl	M251-1643	2408.35	2546.03	2690.29	2762.39	2825.69	2952.55	3068.33	3389.59	3612.43	3942.31
<b>Pneumatic Height Adjustment/Forward-Tilt with Adjustable Air Lumbar</b>												
Polypropylene	Standard	M261-1444	\$2312.12	\$2449.80	\$2594.06	\$2666.16	\$2729.46	\$2856.32	\$2972.10	\$3293.36	\$3516.20	\$3846.08
	Upholstered	M261-1544	2406.12	2543.80	2688.06	2760.16	2823.46	2950.32	3066.10	3387.36	3610.20	3940.08
	Soft Black Vinyl	M261-1644	2406.12	2543.80	2688.06	2760.16	2823.46	2950.32	3066.10	3387.36	3610.20	3940.08

The following options require modification of the product number.

- High arc base
- Plastic base - Low height
- Soft casters
- Faux Leather upholstery
- Leather upholstery
- Stain repellent

- To specify, change the 4th digit from a 1 to a 5; **Example:** M255-1442
- To specify, change the 4th digit from a 1 to a 4; **Example:** M254-1442
- To specify, change the 7th digit from a 4 to a 2; **Example:** M251-1422
- To specify, change the 2nd digit from a 2 to a 3; **Example:** M351-1442
- To specify, change the 2nd digit from a 2 to a 1; **Example:** M151-1442
- To specify, add **-P** to the end of the product number; **Example:** M251-1444-P (add \$69.94 list)

**NOTE:** High arc base available in black only.

For available fabrics, refer to [surfaces.haworth.com](http://surfaces.haworth.com).

# Improv Series

## Improv H.E. High-Back Chair with Flipper Arms



M251-1H42

**NOTE:**  
M261-1G42 offers the best value package of options for this model.

### Dimensions

- \*SH: 16" - 21"  
(406mm - 533mm)
- H: 36.5" - 45"  
(957mm-1143mm)
- D: 24" - 27.25"  
(610mm - 692mm)
- W: 26.5"(673mm)
- \*SW: 19.2"(488mm)
- \*SD: 16" - 19"  
(406mm - 483mm)
- \*AH: 6.2" - 11.3"  
(157mm-287mm)

\* All measurements taken with the BIFMA chair measuring device.

### Features

- Outer Shells: Polypropylene.
- Arms: Standard, upholstered fabric or black vinyl gel arm caps.
- Arm Adjustment Controls: Fingertip activation.
- Arm Adjustment: 5"(127mm) height adjustment.
- Arm Pad Rotation: 360°.
- 3"(76mm) sliding seat pan.
- Casters: Standard with hard casters; for optional soft casters.
- Standard plastic base or optional high arc, or steel base.
- Mechanism: Swivel with synchronized-tilt.
- Height Adjustment: Pneumatic, or pneumatic with low-position seat height option.
- Optional Back-Lock: Lockable in two positions.
- Optional Forward Tilt: Lockable in 3 positions.
- Tilt tension.
- Optional Adjustable Air Lumbar: additional 1.5"(38mm) of lumbar support.
- COM yardage / COL square footage: Polypropylene shell: 2.13/45

### To Order, Specify:

- 1) Product number.
- 2) Fabric surface and color.
- 3) Trim color for shell, arms and base.

Shells	Arms/Caps	Number	Fabric Grade		C	D	E	F	G	H	Leather Grade A	Leather Grade B
			A	B								
<b>Pneumatic Height Adjustment</b>												
Polypropylene	Standard	M251-1H42	\$2591.86	\$2729.54	\$2873.80	\$2945.90	\$3009.20	\$3136.06	\$3251.84	\$3573.10	\$3795.94	\$4125.82
	Vinyl Gel	M251-1G42	2712.06	2849.74	2994.00	3066.10	3129.40	3256.26	3372.04	3693.30	3916.14	4246.02
	Upholstered	M251-1U42	2797.28	2934.96	3079.22	3151.32	3214.62	3341.48	3457.26	3778.52	4001.36	4331.24
<b>Pneumatic Height Adjustment/Back-Lock</b>												
Polypropylene	Standard	M251-1H41	\$2685.86	\$2823.54	\$2967.80	\$3039.90	\$3103.20	\$3230.06	\$3345.84	\$3667.10	\$3889.94	\$4219.82
	Vinyl Gel	M251-1G41	2806.06	2943.74	3088.00	3160.10	3223.40	3350.26	3466.04	3787.30	4010.14	4340.02
	Upholstered	M251-1U41	2891.28	3028.96	3173.22	3245.32	3308.62	3435.48	3551.26	3872.52	4095.36	4425.24
<b>Pneumatic Height Adjustment/Forward-Tilt</b>												
Polypropylene	Standard	M261-1H42	\$2683.63	\$2821.31	\$2965.57	\$3037.67	\$3100.97	\$3227.83	\$3343.61	\$3664.87	\$3887.71	\$4217.59
	Vinyl Gel	M261-1G42	2803.83	2941.51	3085.77	3157.87	3221.17	3348.03	3463.81	3785.07	4007.91	4337.79
	Upholstered	M261-1U42	2889.05	3026.73	3170.99	3243.09	3306.39	3433.25	3549.03	3870.29	4093.13	4423.01
<b>Pneumatic Height Adjustment with Adjustable Air Lumbar</b>												
Polypropylene	Standard	M251-1H44	\$2819.15	\$2956.83	\$3101.09	\$3173.19	\$3236.49	\$3363.35	\$3479.13	\$3800.39	\$4023.23	\$4353.11
	Vinyl Gel	M251-1G44	2939.35	3077.03	3221.29	3293.39	3356.69	3483.55	3599.33	3920.59	4143.43	4473.31
	Upholstered	M251-1U44	3024.57	3162.25	3306.51	3378.61	3441.91	3568.77	3684.55	4005.81	4228.65	4558.53
<b>Pneumatic Height Adjustment/Back-Lock with Adjustable Air Lumbar</b>												
Polypropylene	Standard	M251-1H43	\$2913.15	\$3050.83	\$3195.09	\$3267.19	\$3330.49	\$3457.35	\$3573.13	\$3894.39	\$4117.23	\$4447.11
	Vinyl Gel	M251-1G43	3033.35	3171.03	3315.29	3387.39	3450.69	3577.55	3693.33	4014.59	4237.43	4567.31
	Upholstered	M251-1U43	3118.57	3256.25	3400.51	3472.61	3535.91	3662.77	3778.55	4099.81	4322.65	4652.53
<b>Pneumatic Height Adjustment/Forward-Tilt with Adjustable Air Lumbar</b>												
Polypropylene	Standard	M261-1H44	\$2910.92	\$3048.60	\$3192.86	\$3264.96	\$3328.26	\$3455.12	\$3570.90	\$3892.16	\$4115.00	\$4444.88
	Vinyl Gel	M261-1G44	3031.12	3168.80	3313.06	3385.16	3448.46	3575.32	3691.10	4012.36	4235.20	4565.08
	Upholstered	M261-1U44	3116.34	3254.02	3398.28	3470.38	3533.68	3660.54	3776.32	4097.58	4320.42	4650.30

The following options require modification of the product number.

- High arc base
- Plastic base - Low height
- Soft casters
- Faux Leather upholstery
- Leather upholstery
- Stain repellent

- To specify, change the 4th digit from a 1 to a 5; **Example:** M255-1H42
- To specify, change the 4th digit from a 1 to a 4; **Example:** M254-1H42
- To specify, change the 7th digit from a 4 to a 2; **Example:** M251-1H22
- To specify, change the 2nd digit from a 2 to a 3; **Example:** M351-1H42
- To specify, change the 2nd digit from a 2 to a 1; **Example:** M151-1H42
- To specify, add -P to the end of the product number; **Example:** M251-1H44-P (add \$69.94 list)

**NOTE:** High arc base available in black only.

For available fabrics, refer to [surfaces.haworth.com](http://surfaces.haworth.com).

# Improv Series

## Improv H.E. High-Back Chair with Height and Width Adjustable 3-D Arms



M251-1W42

### Dimensions

- \*SH: 16" - 21"  
(406mm - 533mm)
- H: 36.5" - 45"  
(957mm - 1143mm)
- D: 24" - 27.25"  
(610mm - 692mm)
- W: 25"(635mm)
- \*SW: 19.2"(488mm)
- \*SD: 16" - 19"  
(406mm - 483mm)
- \*AH: 3.75" - 7.75"  
(95mm-197mm)
- \*AW: 25.5" - 29.25"  
(647mm-743mm)

\* All measurements taken with the BIFMA chair measuring device.

### Features

- Outer Shells: Polypropylene.
- Arms: Molded black vinyl.
- 3"(76mm) sliding seat pan.
- Casters: Standard with hard casters; or optional soft casters, see below.
- Standard plastic base or optional high arc, or steel base.
- Mechanism: Swivel with synchronized-tilt.
- Height Adjustment: Pneumatic, or pneumatic with low-position seat height option.
- Arm Adjustment: 4"(102mm) height adjustment.
- Arm Width Adjustment: 1.5"(38mm) per arm in-out adjustment.
- Arm Pad Rotation: 360°.
- Arm Adjustment Controls: Fingertip activation.
- Optional Back-Lock: Lockable in two positions.
- Optional Forward Tilt: Lockable in 3 positions.
- Tilt tension.
- Optional Adjustable Air Lumbar: additional 1.5"(38mm) of lumbar support.
- COM yardage / COL square footage: Polypropylene shell: 2.13/45

### To Order, Specify:

- 1) Product number.
- 2) Fabric surface and color.
- 3) Trim color for shell, arms and base.

Shells	Arms/Caps	Number	Fabric Grade		C	D	E	F	G	H	Leather Grade A	Leather Grade B
			A	B								
<b>Pneumatic Height Adjustment</b>												
Polypropylene	Molded Black Vinyl	M251-1W42	\$2432.31	\$2569.99	\$2714.25	\$2786.35	\$2849.65	\$2976.51	\$3092.29	\$3413.55	\$3636.39	\$3966.27
<b>Pneumatic Height Adjustment/Back-Lock</b>												
Polypropylene	Molded Black Vinyl	M251-1W41	\$2526.31	\$2663.99	\$2808.25	\$2880.35	\$2943.65	\$3070.51	\$3186.29	\$3507.55	\$3730.39	\$4060.27
<b>Pneumatic Height Adjustment/Forward-Tilt</b>												
Polypropylene	Molded Black Vinyl	M261-1W42	\$2524.08	\$2661.76	\$2806.02	\$2878.12	\$2941.42	\$3068.28	\$3184.06	\$3505.32	\$3728.16	\$4058.04
<b>Pneumatic Height Adjustment with Adjustable Air Lumbar</b>												
Polypropylene	Molded Black Vinyl	M251-1W44	\$2659.60	\$2797.28	\$2941.54	\$3013.64	\$3076.94	\$3203.80	\$3319.58	\$3640.84	\$3863.68	\$4193.56
<b>Pneumatic Height Adjustment/Back-Lock with Adjustable Air Lumbar</b>												
Polypropylene	Molded Black Vinyl	M251-1W43	\$2753.60	\$2891.28	\$3035.54	\$3107.64	\$3170.94	\$3297.80	\$3413.58	\$3734.84	\$3957.68	\$4287.56
<b>Pneumatic Height Adjustment/Forward-Tilt with Adjustable Air Lumbar</b>												
Polypropylene	Molded Black Vinyl	M261-1W44	\$2751.37	\$2889.05	\$3033.31	\$3105.41	\$3168.71	\$3295.57	\$3411.35	\$3732.61	\$3955.45	\$4285.33

The following options require modification of the product number.

- High arc base
- Plastic base - Low height
- Soft casters
- Faux Leather upholstery
- Leather upholstery
- Stain repellent

- To specify, change the 4th digit from a 1 to a 5; **Example:** M255-1W42
- To specify, change the 4th digit from a 1 to a 4; **Example:** M254-1W42
- To specify, change the 7th digit from a 4 to a 2; **Example:** M251-1W22
- To specify, change the 2nd digit from a 2 to a 3; **Example:** M351-1W42
- To specify, change the 2nd digit from a 2 to a 1; **Example:** M151-1W42
- To specify, add **-P** to the end of the product number; **Example:** M251-1W42-P (add \$69.94 list)

**NOTE:** High arc base available in black only.

For available fabrics, refer to [surfaces.haworth.com](http://surfaces.haworth.com).

# Improv Series

## Improv H.E. High-Back Chair without Arms



M251-1042

### Dimensions

- \*SH: 16" - 21"  
(406mm - 533mm)
- H: 36.5" - 45"  
(957mm-1143mm)
- D: 24" - 27.25"  
(610mm - 692mm)
- W: 26.5"(673mm)
- \*SW: 19.2"(488mm)
- \*SD: 16" - 19"  
(406mm - 483mm)

\* All measurements taken with the BIFMA chair measuring device.

### Features

- Outer Shells: Polypropylene.
- Casters: Standard with hard casters; or optional soft casters, see below.
- 3"(76mm) sliding seat pan.
- Standard plastic base or optional high arc, or steel base.
- Mechanism: Swivel with synchronized-tilt.
- Height Adjustment: Pneumatic.
- Optional Back-Lock: Lockable in two positions.
- Optional Forward Tilt: Lockable in 3 positions.
- Tilt tension.
- Optional Adjustable Air Lumbar: additional 1.5"(38mm) of lumbar support.
- COM yardage / COL square footage: Polypropylene shell: 2.13/45

### To Order, Specify:

- 1) Product number.
- 2) Fabric surface and color.
- 3) Trim color for shell and base.

Shells	Number	Fabric Grade								Leather Grade A	Leather Grade B
		A	B	C	D	E	F	G	H		
<b>Pneumatic Height Adjustment</b>											
Polypropylene	M251-1042	\$1809.47	\$1947.15	\$2091.41	\$2163.51	\$2226.81	\$2353.67	\$2469.45	\$2790.71	\$3013.55	\$3343.43
<b>Pneumatic Height Adjustment/Back-Lock</b>											
Polypropylene	M251-1041	\$1903.47	\$2041.15	\$2185.41	\$2257.51	\$2320.81	\$2447.67	\$2563.45	\$2884.71	\$3107.55	\$3437.43
<b>Pneumatic Height Adjustment/Forward-Tilt</b>											
Polypropylene	M261-1042	\$1901.24	\$2038.92	\$2183.18	\$2255.28	\$2318.58	\$2445.44	\$2561.22	\$2882.48	\$3105.32	\$3435.20
<b>Pneumatic Height Adjustment with Adjustable Air Lumbar</b>											
Polypropylene	M251-1044	\$2036.76	\$2174.44	\$2318.70	\$2390.80	\$2454.10	\$2580.96	\$2696.74	\$3018.00	\$3240.84	\$3570.72
<b>Pneumatic Height Adjustment/Back-Lock with Adjustable Air Lumbar</b>											
Polypropylene	M251-1043	\$2130.76	\$2268.44	\$2412.70	\$2484.80	\$2548.10	\$2674.96	\$2790.74	\$3112.00	\$3334.84	\$3664.72
<b>Pneumatic Height Adjustment/Forward-Tilt with Adjustable Air Lumbar</b>											
Polypropylene	M261-1044	\$2128.53	\$2266.21	\$2410.47	\$2482.57	\$2545.87	\$2672.73	\$2788.51	\$3109.77	\$3332.61	\$3662.49

The following options require modification of the product number.

- High arc base
- Plastic base - Low height
- Soft casters
- Faux Leather upholstery
- Leather upholstery
- Stain repellent

- To specify, change the 4th digit from a 1 to a 5; **Example:** M255-1042
- To specify, change the 4th digit from a 1 to a 4; **Example:** M254-1042
- To specify, change the 7th digit from a 4 to a 2; **Example:** M251-1022
- To specify, change the 2nd digit from a 2 to a 3; **Example:** M351-1042
- To specify, change the 2nd digit from a 2 to a 1; **Example:** M151-1042
- To specify, add -P to the end of the product number; **Example:** M251-1042-P (add \$69.94 list)

**NOTE:** High arc base available in black only.

For available fabrics, refer to [surfaces.haworth.com](http://surfaces.haworth.com).

# Improv Series

## Improv H.E. Mid-Back Chair with Task Arms



M231-1442

### Dimensions

- \*SH: 16" - 21"  
(406mm - 533mm)
- H: 34" - 42.5"  
(864mm - 1080mm)
- D: 23" - 25.5"  
(584mm - 648mm)
- W: 25"(635mm)
- \*SW: 19.2"(488mm)
- \*SD: 16" - 19"  
(406mm - 483mm)
- \*AH: 9.625"(244mm)

\* All measurements taken with the BIFMA chair measuring device.

### Features

- Outer Shells: Polypropylene.
- Arms: Standard, upholstered fabric or soft black vinyl arm caps.
- Casters: Standard with hard casters; or optional soft casters.
- 3"(76mm) sliding seat pan.
- Standard plastic base or optional high arc, or steel base.
- Mechanism: Swivel with synchronized-tilt.
- Height Adjustment: Pneumatic, or pneumatic with low-position seat height.
- Optional Back-Lock: Lockable in two positions.
- Optional Forward Tilt: Lockable in 3 positions.
- Tilt tension.
- Optional Adjustable Air Lumbar: additional 1.5"(38mm) of lumbar support.
- COM yardage / COL square footage: Polypropylene shell: 1.50/39

### To Order, Specify:

- 1) Product number.
- 2) Fabric surface and color.
- 3) Trim color for shell, arms and base.

Shells	Arms/Caps	Number	Fabric Grade		C	D	E	F	G	H	Leather Grade A	Leather Grade B
			A	B								
<b>Pneumatic Height Adjustment</b>												
Polypropylene	Standard	M231-1442	\$1846.66	\$1984.34	\$2128.60	\$2200.70	\$2264.00	\$2390.86	\$2506.64	\$2827.90	\$3050.74	\$3380.62
	Upholstered	M231-1542	1940.66	2078.34	2222.60	2294.70	2358.00	2484.86	2600.64	2921.90	3144.74	3474.62
	Soft Black Vinyl	M231-1642	1940.66	2078.34	2222.60	2294.70	2358.00	2484.86	2600.64	2921.90	3144.74	3474.62
<b>Pneumatic Height Adjustment/Back-Lock</b>												
Polypropylene	Standard	M231-1441	\$1940.66	\$2078.34	\$2222.60	\$2294.70	\$2358.00	\$2484.86	\$2600.64	\$2921.90	\$3144.74	\$3474.62
	Upholstered	M231-1541	2034.66	2172.34	2316.60	2388.70	2452.00	2578.86	2694.64	3015.90	3238.74	3568.62
	Soft Black Vinyl	M231-1641	2034.66	2172.34	2316.60	2388.70	2452.00	2578.86	2694.64	3015.90	3238.74	3568.62
<b>Pneumatic Height Adjustment/Forward-Tilt</b>												
Polypropylene	Standard	M241-1442	\$1938.43	\$2076.11	\$2220.37	\$2292.47	\$2355.77	\$2482.63	\$2598.41	\$2919.67	\$3142.51	\$3472.39
	Upholstered	M241-1542	2032.43	2170.11	2314.37	2386.47	2449.77	2576.63	2692.41	3013.67	3236.51	3566.39
	Soft Black Vinyl	M241-1642	2032.43	2170.11	2314.37	2386.47	2449.77	2576.63	2692.41	3013.67	3236.51	3566.39
<b>Pneumatic Height Adjustment with Adjustable Air Lumbar</b>												
Polypropylene	Standard	M231-1444	\$2073.95	\$2211.63	\$2355.89	\$2427.99	\$2491.29	\$2618.15	\$2733.93	\$3055.19	\$3278.03	\$3607.91
	Upholstered	M231-1544	2167.95	2305.63	2449.89	2521.99	2585.29	2712.15	2827.93	3149.19	3372.03	3701.91
	Soft Black Vinyl	M231-1644	2167.95	2305.63	2449.89	2521.99	2585.29	2712.15	2827.93	3149.19	3372.03	3701.91
<b>Pneumatic Height Adjustment/Back-Lock with Adjustable Air Lumbar</b>												
Polypropylene	Standard	M231-1443	\$2167.95	\$2305.63	\$2449.89	\$2521.99	\$2585.29	\$2712.15	\$2827.93	\$3149.19	\$3372.03	\$3701.91
	Upholstered	M231-1543	2261.95	2399.63	2543.89	2615.99	2679.29	2806.15	2921.93	3243.19	3466.03	3795.91
	Soft Black Vinyl	M231-1643	2261.95	2399.63	2543.89	2615.99	2679.29	2806.15	2921.93	3243.19	3466.03	3795.91
<b>Pneumatic Height Adjustment/Forward-Tilt with Adjustable Air Lumbar</b>												
Polypropylene	Standard	M241-1444	\$2165.72	\$2303.40	\$2447.66	\$2519.76	\$2583.06	\$2709.92	\$2825.70	\$3146.96	\$3369.80	\$3699.68
	Upholstered	M241-1544	2259.72	2397.40	2541.66	2613.76	2677.06	2803.92	2919.70	3240.96	3463.80	3793.68
	Soft Black Vinyl	M241-1644	2259.72	2397.40	2541.66	2613.76	2677.06	2803.92	2919.70	3240.96	3463.80	3793.68

The following options require modification of the product number.

- Low-position seat height - Plastic
- High arc base
- Soft casters
- Faux Leather upholstery
- Leather upholstery
- Stain repellent

- To specify, change the 4th digit from a 1 to a 4; **Example:** M234-1442
- To specify, change the 4th digit from a 1 to a 5; **Example:** M235-1442
- To specify, change the 7th digit from a 4 to a 2; **Example:** M231-1422
- To specify, change the 2nd digit from a 2 to a 3; **Example:** M331-1442
- To specify, change the 2nd digit from a 2 to a 1; **Example:** M131-1442
- To specify, add **-P** to the end of the product number; **Example:** M231-1444-P (add \$69.94 list)

**NOTE:** High arc base available in black only.

For available fabrics, refer to [surfaces.haworth.com](https://surfaces.haworth.com).

# Improv Series

## Improv H.E. Mid-Back Chair with Flipper Arms



M231-1H42

**NOTE:**  
M241-1G42 offers the best value package of options for this model.

### Dimensions

- \*SH: 16" - 21"  
(406mm - 533mm)
- H: 34" - 42.5"  
(864mm-1080mm)
- D: 23" - 25.5"  
(584mm - 648mm)
- W: 26.5"(673mm)
- \*SW: 19.2"(488mm)
- \*SD: 16" - 19"  
(406mm - 483mm)
- \*AH: 6.2" - 11.3"  
(157mm-287mm)

\* All measurements taken with the BIFMA chair measuring device.

### Features

- Outer Shells: Polypropylene.
- Arms: Standard, upholstered fabric or black vinyl gel arm caps.
- Arm Adjustment Controls: Fingertip activation.
- 3"(76mm) Sliding seat pan.
- Casters: Standard with hard casters; or optional soft casters.
- Standard plastic base or optional high arc, or steel base.
- Mechanism: Swivel with synchronized-tilt.
- Height Adjustment: Pneumatic, or pneumatic with low-position seat height option.
- Arm Adjustment: 5"(127mm) height adjustment.
- Arm Pad Rotation: 360°.
- Optional Back-Lock: Lockable in two positions.
- Optional Forward Tilt: Lockable in 3 positions.
- Tilt tension.
- Optional Adjustable Air Lumbar: additional 1.5"(38mm) of lumbar support.
- COM yardage / COL square footage:  
Polypropylene shell: 1.50/39

### To Order, Specify:

- 1) Product number.
- 2) Fabric surface and color.
- 3) Trim color for shell, arms and base.

Shells	Arms/Caps	Number	Fabric Grade		C	D	E	F	G	H	Leather Grade A	Leather Grade B
			A	B								
<b>Pneumatic Height Adjustment</b>												
Polypropylene	Standard	M231-1H42	\$2445.46	\$2583.14	\$2727.40	\$2799.50	\$2862.80	\$2989.66	\$3105.44	\$3426.70	\$3649.54	\$3979.42
	Vinyl Gel	M231-1G42	2565.66	2703.34	2847.60	2919.70	2983.00	3109.86	3225.64	3546.90	3769.74	4099.62
	Upholstered	M231-1U42	2650.88	2788.56	2932.82	3004.92	3068.22	3195.08	3310.86	3632.12	3854.96	4184.84
<b>Pneumatic Height Adjustment/Back-Lock</b>												
Polypropylene	Standard	M231-1H41	\$2539.46	\$2677.14	\$2821.40	\$2893.50	\$2956.80	\$3083.66	\$3199.44	\$3520.70	\$3743.54	\$4073.42
	Vinyl Gel	M231-1G41	2659.66	2797.34	2941.60	3013.70	3077.00	3203.86	3319.64	3640.90	3863.74	4193.62
	Upholstered	M231-1U41	2744.88	2882.56	3026.82	3098.92	3162.22	3289.08	3404.86	3726.12	3948.96	4278.84
<b>Pneumatic Height Adjustment/Forward-Tilt</b>												
Polypropylene	Standard	M241-1H42	\$2537.23	\$2674.91	\$2819.17	\$2891.27	\$2954.57	\$3081.43	\$3197.21	\$3518.47	\$3741.31	\$4071.19
	Vinyl Gel	M241-1G42	2657.43	2795.11	2939.37	3011.47	3074.77	3201.63	3317.41	3638.67	3861.51	4191.39
	Upholstered	M241-1U42	2742.65	2880.33	3024.59	3096.69	3159.99	3286.85	3402.63	3723.89	3946.73	4276.61
<b>Pneumatic Height Adjustment with Adjustable Air Lumbar</b>												
Polypropylene	Standard	M231-1H44	\$2672.75	\$2810.43	\$2954.69	\$3026.79	\$3090.09	\$3216.95	\$3332.73	\$3653.99	\$3876.83	\$4206.71
	Vinyl Gel	M231-1G44	2792.95	2930.63	3074.89	3146.99	3210.29	3337.15	3452.93	3774.19	3997.03	4326.91
	Upholstered	M231-1U44	2878.17	3015.85	3160.11	3232.21	3295.51	3422.37	3538.15	3859.41	4082.25	4412.13
<b>Pneumatic Height Adjustment/Back-Lock with Adjustable Air Lumbar</b>												
Polypropylene	Standard	M231-1H43	\$2766.75	\$2904.43	\$3048.69	\$3120.79	\$3184.09	\$3310.95	\$3426.73	\$3747.99	\$3970.83	\$4300.71
	Vinyl Gel	M231-1G43	2886.95	3024.63	3168.89	3240.99	3304.29	3431.15	3546.93	3868.19	4091.03	4420.91
	Upholstered	M231-1U43	2972.17	3109.85	3254.11	3326.21	3389.51	3516.37	3632.15	3953.41	4176.25	4506.13
<b>Pneumatic Height Adjustment/Forward-Tilt with Adjustable Air Lumbar</b>												
Polypropylene	Standard	M241-1H44	\$2764.52	\$2902.20	\$3046.46	\$3118.56	\$3181.86	\$3308.72	\$3424.50	\$3745.76	\$3968.60	\$4298.48
	Vinyl Gel	M241-1G44	2884.72	3022.40	3166.66	3238.76	3302.06	3428.92	3544.70	3865.96	4088.80	4418.68
	Upholstered	M241-1U44	2969.94	3107.62	3251.88	3323.98	3387.28	3514.14	3629.92	3951.18	4174.02	4503.90

The following options require modification of the product number.

- Low-position seat height - Plastic
- High arc base
- Soft casters
- Faux Leather upholstery
- Leather upholstery
- Stain repellent

- To specify, change the 4th digit from a 1 to a 4; **Example:** M234-1H42
- To specify, change the 4th digit from a 1 to a 5; **Example:** M235-1H42
- To specify, change the 7th digit from a 4 to a 2; **Example:** M231-1H22
- To specify, change the 2nd digit from a 2 to a 3; **Example:** M331-1H42
- To specify, change the 2nd digit from a 2 to a 1; **Example:** M131-1H42
- To specify, add **-P** to the end of the product number; **Example:** M231-1H44-P (add \$69.94 list)

**NOTE:** High arc base available in black only.

For available fabrics, refer to [surfaces.haworth.com](http://surfaces.haworth.com).



# Improv Series

## Improv H.E. Mid-Back Chair with Height and Width Adjustable 3-D Arms



M231-1W42

### Dimensions

- SH: 16" - 21"  
(406mm - 533mm)
- H: 34" - 42.5"  
(864mm - 1080mm)
- D: 23" - 25.5"  
(584mm - 648mm)
- W: 25"(635mm)
- \*SW: 19.2"(488mm)
- \*SD: 16" - 19"  
(406mm - 483mm)
- \*AH: 3.75" - 7.75"  
(95mm-197mm)
- \*AW: 25.5" - 29.25"  
(648mm-743mm)

\* All measurements taken with the BIFMA chair measuring device.

### Features

- Outer Shells: Polypropylene.
- Arms: Molded black vinyl.
- 3"(76mm) Sliding seat pan.
- Casters: Standard with hard casters; or optional soft casters, see below.
- Standard plastic base or optional high arc, or steel base.
- Mechanism: Swivel with synchronized-tilt.
- Height Adjustment: Pneumatic, or pneumatic with low-position seat height option.
- Arm Adjustment: 4"(102mm) height adjustment.
- Arm Width Adjustment: 1.5"(38mm) each arm in-out adjustment.
- Arm Pad Rotation: 360°.
- Arm Adjustment Controls: Fingertip activation.
- Optional Back-Lock: Lockable in two positions.
- Optional Forward Tilt: Lockable in 3 positions.
- Tilt tension.
- Optional Adjustable Air Lumbar: additional 1.5"(38mm) of lumbar support.
- COM yardage / COL square footage: Polypropylene shell: 1.50/39

### To Order, Specify:

- 1) Product number.
- 2) Fabric surface and color.
- 3) Trim color for shell, arms and base.

Shells	Arms/Caps	Number	Fabric Grade		C	D	E	F	G	H	Leather Grade A	Leather Grade B
			A	B								
<b>Pneumatic Height Adjustment</b>												
Polypropylene	Molded Black Vinyl	M231-1W42	\$2285.91	\$2423.59	\$2567.85	\$2639.95	\$2703.25	\$2830.11	\$2945.89	\$3267.15	\$3489.99	\$3819.87
<b>Pneumatic Height Adjustment/Back-Lock</b>												
Polypropylene	Molded Black Vinyl	M231-1W41	\$2379.91	\$2517.59	\$2661.85	\$2733.95	\$2797.25	\$2924.11	\$3039.89	\$3361.15	\$3583.99	\$3913.87
<b>Pneumatic Height Adjustment/Forward-Tilt</b>												
Polypropylene	Molded Black Vinyl	M241-1W42	\$2377.68	\$2515.36	\$2659.62	\$2731.72	\$2795.02	\$2921.88	\$3037.66	\$3358.92	\$3581.76	\$3911.64
<b>Pneumatic Height Adjustment with Adjustable Air Lumbar</b>												
Polypropylene	Molded Black Vinyl	M231-1W44	\$2513.20	\$2650.88	\$2795.14	\$2867.24	\$2930.54	\$3057.40	\$3173.18	\$3494.44	\$3717.28	\$4047.16
<b>Pneumatic Height Adjustment/Back-Lock with Adjustable Air Lumbar</b>												
Polypropylene	Molded Black Vinyl	M231-1W43	\$2607.20	\$2744.88	\$2889.14	\$2961.24	\$3024.54	\$3151.40	\$3267.18	\$3588.44	\$3811.28	\$4141.16
<b>Pneumatic Height Adjustment/Forward-Tilt with Adjustable Air Lumbar</b>												
Polypropylene	Molded Black Vinyl	M241-1W44	\$2604.97	\$2742.65	\$2886.91	\$2959.01	\$3022.31	\$3149.17	\$3264.95	\$3586.21	\$3809.05	\$4138.93

The following options require modification of the product number.

- Low-position seat height - Plastic
- High arc base
- Soft casters
- Faux Leather upholstery
- Leather upholstery
- Stain repellent

- To specify, change the 4th digit from a 1 to a 4; **Example:** M234-1W42
- To specify, change the 4th digit from a 1 to a 5; **Example:** M235-1W42
- To specify, change the 7th digit from a 4 to a 2; **Example:** M231-1W22
- To specify, change the 2nd digit from a 2 to a 3; **Example:** M331-1W42
- To specify, change the 2nd digit from a 2 to a 1; **Example:** M131-1W42
- To specify, add -P to the end of the product number; **Example:** M231-1W42-P (add \$69.94 list)

**NOTE:** High arc base available in black only.

For available fabrics, refer to [surfaces.haworth.com](http://surfaces.haworth.com).

# Improv Series

Improv H.E. Mid-Back Chair without Arms



M231-1042

### Dimensions

- \*SH: 16" - 21"  
(406mm - 533mm)
- H: 34" - 42.5"  
(864mm - 1080mm)
- D: 23" - 25.5"  
(584mm - 648mm)
- W: 26.5"(673mm)
- \*SW: 19.2"(488mm)
- \*SD: 16" - 19"  
(406mm - 483mm)

\* All measurements taken with the BIFMA chair measuring device.

### Features

- Outer Shells: Polypropylene.
- 3"(76mm) Sliding seat pan.
- Casters: Standard with hard casters; or optional soft casters, see below.
- Standard plastic base or optional high arc, or steel base.
- Mechanism: Swivel with synchronized-tilt.
- Height Adjustment: Pneumatic, or pneumatic with low-position seat height option.
- Optional Back-Lock: Lockable in two positions.
- Optional Forward Tilt: Lockable in 3 positions.
- Tilt tension.
- Optional Adjustable Air Lumbar models available: additional 1.5"(38mm) of lumbar support.
- COM yardage / COL square footage: Polypropylene shell: 1.50/39

### To Order, Specify:

- 1) Product number.
- 2) Fabric surface and color.
- 3) Trim color for shell and base.

Shells	Number	Fabric Grade		C	D	E	F	G	H	Leather Grade A	Leather Grade B
		A	B								
<b>Pneumatic Height Adjustment</b>											
Polypropylene	M231-1042	\$1663.07	\$1800.75	\$1945.01	\$2017.11	\$2080.41	\$2207.27	\$2323.05	\$2644.31	\$2867.15	\$3197.03
<b>Pneumatic Height Adjustment/Back-Lock</b>											
Polypropylene	M231-1041	\$1757.07	\$1894.75	\$2039.01	\$2111.11	\$2174.41	\$2301.27	\$2417.05	\$2738.31	\$2961.15	\$3291.03
<b>Pneumatic Height Adjustment/Forward-Tilt</b>											
Polypropylene	M241-1042	\$1754.84	\$1892.52	\$2036.78	\$2108.88	\$2172.18	\$2299.04	\$2414.82	\$2736.08	\$2958.92	\$3288.80
<b>Pneumatic Height Adjustment with Adjustable Lumbar</b>											
Polypropylene	M231-1044	\$1890.36	\$2028.04	\$2172.30	\$2244.40	\$2307.70	\$2434.56	\$2550.34	\$2871.60	\$3094.44	\$3424.32
<b>Pneumatic Height Adjustment/Back-Lock with Adjustable Air Lumbar</b>											
Polypropylene	M231-1043	\$1984.36	\$2122.04	\$2266.30	\$2338.40	\$2401.70	\$2528.56	\$2644.34	\$2965.60	\$3188.44	\$3518.32
<b>Pneumatic Height Adjustment/Forward-Tilt with Adjustable Air Lumbar</b>											
Polypropylene	M241-1044	\$1982.13	\$2119.81	\$2264.07	\$2336.17	\$2399.47	\$2526.33	\$2642.11	\$2963.37	\$3186.21	\$3516.09

The following options require modification of the product number.

- Low-position seat height - Plastic
- High arc base
- Soft casters
- Faux Leather upholstery
- Leather upholstery
- Stain repellent

- To specify, change the 4th digit from a 1 to a 4; **Example:** M234-1042
- To specify, change the 4th digit from a 1 to a 5; **Example:** M235-1042
- To specify, change the 7th digit from a 4 to a 2; **Example:** M231-1022
- To specify, change the 2nd digit from a 2 to a 3; **Example:** M331-1042
- To specify, change the 2nd digit from a 2 to a 1; **Example:** M131-1042
- To specify, add **-P** to the end of the product number; **Example:** M231-1042-P (add \$69.94 list)

**NOTE:** High arc base available in black only.

For available fabrics, refer to [surfaces.haworth.com](http://surfaces.haworth.com).

# Improv Series

Improv H.E. Stool with Task Arms



M2E1-1442

### Dimensions

- \*SH: 24" - 32"  
(610mm - 813mm)
- H: 42" - 54"  
(1067mm - 1372mm)
- D: 23" - 25.5"  
(584mm - 648mm)
- W: 25"(635mm)
- \*SW: 19.2"(488mm)
- \*SD: 18"(459mm)
- \*AH: 9.6"(244mm)

\* All measurements taken with the BIFMA chair measuring device.

### Features

- Outer Shells: Polypropylene.
- Arms: Standard, upholstered fabric or soft black vinyl arm caps.
- Casters: Standard with hard casters; or optional soft casters or glides.
- Mechanism: Swivel with synchronized-tilt.
- Height Adjustment: Pneumatic
- Optional Back-Lock: Lockable in two positions.
- Tilt tension.
- Optional Adjustable Air Lumbar: additional 1.5"(38mm) of lumbar support.
- Forward tilt not available on stools.
- Seat pan can be manually adjusted 3"(76mm).  
Foot ring adjustment: 6.5" - 15"  
(165mm - 381mm).
- Foot ring available in chrome only; ring support black only; base cover will match trim color.
- COM yardage / COL square footage:  
Polypropylene shell: 1.75/39

### To Order, Specify:

- 1) Product number.
- 2) Fabric surface and color.
- 3) Trim color for shell, arms and base.

Shells	Arms/Caps	Number	Fabric Grade								Leather Grade A	Leather Grade B
			A	B	C	D	E	F	G	H		
<b>Pneumatic Height Adjustment</b>												
Polypropylene	Standard	M2E1-1442	\$2834.46	\$2972.14	\$3116.40	\$3188.50	\$3251.80	\$3378.66	\$3494.44	\$3815.70	\$4038.54	\$4368.42
	Upholstered	M2E1-1542	2928.46	3066.14	3210.40	3282.50	3345.80	3472.66	3588.44	3909.70	4132.54	4462.42
	Soft Black Vinyl	M2E1-1642	2928.46	3066.14	3210.40	3282.50	3345.80	3472.66	3588.44	3909.70	4132.54	4462.42
<b>Pneumatic Height Adjustment/Back-Lock</b>												
Polypropylene	Standard	M2E1-1441	\$2928.46	\$3066.14	\$3210.40	\$3282.50	\$3345.80	\$3472.66	\$3588.44	\$3909.70	\$4132.54	\$4462.42
	Upholstered	M2E1-1541	3022.46	3160.14	3304.40	3376.50	3439.80	3566.66	3682.44	4003.70	4226.54	4556.42
	Soft Black Vinyl	M2E1-1641	3022.46	3160.14	3304.40	3376.50	3439.80	3566.66	3682.44	4003.70	4226.54	4556.42
<b>Pneumatic Height Adjustment with Adjustable Air Lumbar</b>												
Polypropylene	Standard	M2E1-1444	\$3061.75	\$3199.43	\$3343.69	\$3415.79	\$3479.09	\$3605.95	\$3721.73	\$4042.99	\$4265.83	\$4595.71
	Upholstered	M2E1-1544	3155.75	3293.43	3437.69	3509.79	3573.09	3699.95	3815.73	4136.99	4359.83	4689.71
	Soft Black Vinyl	M2E1-1644	3155.75	3293.43	3437.69	3509.79	3573.09	3699.95	3815.73	4136.99	4359.83	4689.71
<b>Pneumatic Height Adjustment/Back-Lock with Adjustable Air Lumbar</b>												
Polypropylene	Standard	M2E1-1443	\$3155.75	\$3293.43	\$3437.69	\$3509.79	\$3573.09	\$3699.95	\$3815.73	\$4136.99	\$4359.83	\$4689.71
	Upholstered	M2E1-1543	3249.75	3387.43	3531.69	3603.79	3667.09	3793.95	3909.73	4230.99	4453.83	4783.71
	Soft Black Vinyl	M2E1-1643	3249.75	3387.43	3531.69	3603.79	3667.09	3793.95	3909.73	4230.99	4453.83	4783.71

The following options require modification of the product number.

- Glides
- Soft casters
- Faux Leather upholstery
- Leather upholstery
- Stain repellent

- To specify, change the 7th digit from a 4 to a 0; **Example:** M2E1-1402
- To specify, change the 7th digit from a 4 to a 2; **Example:** M2E1-1422
- To specify, change the 2nd digit from a 2 to a 3; **Example:** M3E1-1442
- To specify, change the 2nd digit from a 2 to a 1; **Example:** M1E1-1442
- To specify, add **-P** to the end of the product number; **Example:** M2E1-1444-P (add \$69.94 list)

**NOTE:** For available fabrics, refer to [surfaces.haworth.com](https://surfaces.haworth.com).

# Improv Series

## Improv H.E. Stool with Flipper Arms



M2E1-1H42

### Dimensions

- \*SH: 24" - 32"  
(610mm - 813mm)
- H: 42" - 54"  
(1067mm - 1372mm)
- D: 23" - 25.5"  
(584mm - 648mm)
- W: 26.5"(673mm)
- \*SW: 19.2"(488mm)
- \*SD: 18"(458mm)
- \*AH: 6.2" - 11.3"  
(157mm - 282mm)

\* All measurements taken with the BIFMA chair measuring device.

### Features

- Outer Shells: Polypropylene.
- Arms: Standard, upholstered fabric or black vinyl arm caps.
- Arm Adjustment Controls: Fingertip activation.
- Arm Adjustment: 5"(127mm) height adjustment, 360° rotation.
- Standard with hard casters; or optional soft casters or glides.
- Mechanism: Swivel with synchronized-tilt.
- Height Adjustment: Pneumatic
- Optional Back-Lock: Lockable in two positions.
- Tilt tension.
- Optional Adjustable Air Lumbar: additional 1.5"(38mm) of lumbar support.
- Forward tilt not available on stools.
- Seat pan can be manually adjusted 3"(76mm).
- Foot ring adjustment: 6.5" - 15" (165mm - 381mm).
- Foot ring available in chrome only; ring support black only; base cover will match trim color.
- COM yardage / COL square footage:  
Polypropylene shell: 1.75/39

### To Order, Specify:

- 1) Product number.
- 2) Fabric surface and color.
- 3) Trim color for shell, arms and base.

Shells	Arms/Caps	Number	Fabric Grade		C	D	E	F	G	H	Leather Grade A	Leather Grade B
			A	B								
<b>Pneumatic Height Adjustment</b>												
Polypropylene	Standard	M2E1-1H42	\$3433.26	\$3570.94	\$3715.20	\$3787.30	\$3850.60	\$3977.46	\$4093.24	\$4414.50	\$4637.34	\$4967.22
	Vinyl Gel	M2E1-1G42	3553.46	3691.14	3835.40	3907.50	3970.80	4097.66	4213.44	4534.70	4757.54	5087.42
	Upholstered	M2E1-1U42	3638.68	3776.36	3920.62	3992.72	4056.02	4182.88	4298.66	4619.92	4842.76	5172.64
<b>Pneumatic Height Adjustment/Back-Lock</b>												
Polypropylene	Standard	M2E1-1H41	\$3527.26	\$3664.94	\$3809.20	\$3881.30	\$3944.60	\$4071.46	\$4187.24	\$4508.50	\$4731.34	\$5061.22
	Vinyl Gel	M2E1-1G41	3647.46	3785.14	3929.40	4001.50	4064.80	4191.66	4307.44	4628.70	4851.54	5181.42
	Upholstered	M2E1-1U41	3732.68	3870.36	4014.62	4086.72	4150.02	4276.88	4392.66	4713.92	4936.76	5266.64
<b>Pneumatic Height Adjustment with Adjustable Air Lumbar</b>												
Polypropylene	Standard	M2E1-1H44	\$3660.55	\$3798.23	\$3942.49	\$4014.59	\$4077.89	\$4204.75	\$4320.53	\$4641.79	\$4864.63	\$5194.51
	Vinyl Gel	M2E1-1G44	3780.75	3918.43	4062.69	4134.79	4198.09	4324.95	4440.73	4761.99	4984.83	5314.71
	Upholstered	M2E1-1U44	3865.97	4003.65	4147.91	4220.01	4283.31	4410.17	4525.95	4847.21	5070.05	5399.93
<b>Pneumatic Height Adjustment/Back-Lock with Adjustable Air Lumbar</b>												
Polypropylene	Standard	M2E1-1H43	\$3754.55	\$3892.23	\$4036.49	\$4108.59	\$4171.89	\$4298.75	\$4414.53	\$4735.79	\$4958.63	\$5288.51
	Vinyl Gel	M2E1-1G43	3874.75	4012.43	4156.69	4228.79	4292.09	4418.95	4534.73	4855.99	5078.83	5408.71
	Upholstered	M2E1-1U43	3959.97	4097.65	4241.91	4314.01	4377.31	4504.17	4619.95	4941.21	5164.05	5493.93

The following options require modification of the product number.

Glides

Soft casters

Faux Leather upholstery

Leather upholstery

Stain repellent

To specify, change the 7th digit from a 4 to a 0; **Example:** M2E1-1H02

To specify, change the 7th digit from a 4 to a 2; **Example:** M2E1-1H22

To specify, change the 2nd digit from a 2 to a 3; **Example:** M3E1-1H42

To specify, change the 2nd digit from a 2 to a 1; **Example:** M1E1-1H42

To specify, add -P to the end of the product number; **Example:** M2E1-2U42-P (add \$69.94 list)

**NOTE:** For available fabrics, refer to [surfaces.haworth.com](https://surfaces.haworth.com).

# Improv Series

## Improv H.E. Stool with Height and Width Adjustable 3-D Arms



M2E1-1W42

### Dimensions

- \*SH: 24" - 32"  
(610mm - 813mm)
- H: 42" - 54"  
(1067mm - 1372mm)
- D: 23" - 25.5"  
(584mm - 648mm)
- W: 25"(635mm)
- \*SW: 19.2"(488mm)
- \*SD: 18"(458mm)
- \*AH: 3.75" - 7.75"  
(95mm - 197mm)
- \*AW: 25.5" - 29.25"  
(648mm - 743mm)

\* All measurements taken with the BIFMA chair measuring device.

### Features

- Outer Shells: Polypropylene.
- Arms: Molded black vinyl arm caps.
- Standard with hard casters; or optional soft casters or glides, see below.
- Mechanism: Swivel with synchronized-tilt.
- Height Adjustment: Pneumatic
- Arm Adjustment: 5"(127mm) height adjustment.
- Arm Width Adjustment: 1.5"(38mm) each arm in-out adjustment.
- Arm Pad Rotation: 360°.
- Arm Adjustment Controls: Fingertip activation.
- Optional Back-Lock: Lockable in two positions.
- Tilt tension.
- Optional Adjustable Air Lumbar: additional 1.5"(38mm) of lumbar support.
- Forward tilt not available on stools.
- Seat pan can be manually adjusted 3"(76mm).
- Foot ring adjustment: 6.5" - 15"  
(165mm - 381mm).
- Foot ring available in chrome only; ring support black only; base cover will match trim color.
- COM yardage / COL square footage:  
Polypropylene shell: 1.75/39

### To Order, Specify:

- 1) Product number.
- 2) Fabric surface and color.
- 3) Trim color for shell, arms and base.

Shells	Arms/Caps	Number	Fabric Grade								Leather Grade A	Leather Grade B
			A	B	C	D	E	F	G	H		
<b>Pneumatic Height Adjustment</b>												
Polypropylene	Molded Black Vinyl	M2E1-1W42	\$3273.71	\$3411.39	\$3555.65	\$3627.75	\$3691.05	\$3817.91	\$3933.69	\$4254.95	\$4477.79	\$4807.67
<b>Pneumatic Height Adjustment/Back-Lock</b>												
Polypropylene	Molded Black Vinyl	M2E1-1W41	\$3367.71	\$3505.39	\$3649.65	\$3721.75	\$3785.05	\$3911.91	\$4027.69	\$4348.95	\$4571.79	\$4901.67
<b>Pneumatic Height Adjustment with Adjustable Air Lumbar</b>												
Polypropylene	Molded Black Vinyl	M2E1-1W44	\$3501.00	\$3638.68	\$3782.94	\$3855.04	\$3918.34	\$4045.20	\$4160.98	\$4482.24	\$4705.08	\$5034.96
<b>Pneumatic Height Adjustment/Back-Lock with Adjustable Air Lumbar</b>												
Polypropylene	Molded Black Vinyl	M2E1-1W43	\$3595.00	\$3732.68	\$3876.94	\$3949.04	\$4012.34	\$4139.20	\$4254.98	\$4576.24	\$4799.08	\$5128.96

The following options require modification of the product number.

- |   |   |
|---|---|
| <ul style="list-style-type: none"> <li>Glide</li> <li>Soft casters</li> <li>Faux Leather upholstery</li> <li>Leather upholstery</li> <li>Stain repellent</li> </ul> | <ul style="list-style-type: none"> <li>To specify, change the 7th digit from a 4 to a 0; <b>Example:</b> M2E1-1W02</li> <li>To specify, change the 7th digit from a 4 to a 2; <b>Example:</b> M2E1-1W22</li> <li>To specify, change the 2nd digit from a 2 to a 3; <b>Example:</b> M3E1-1W42</li> <li>To specify, change the 2nd digit from a 2 to a 1; <b>Example:</b> M1E1-1W42</li> <li>To specify, add -P to the end of the product number; <b>Example:</b> M2E1-1W42-P (add \$69.94 list)</li> </ul> |
|---|---|

**NOTE:** For available fabrics, refer to [surfaces.haworth.com](https://surfaces.haworth.com).

# Improv Series

## Improv H.E. Stool without Arms

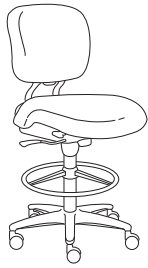

M2E1-1042

### Dimensions

- \*SH: 24" - 32"  
(610mm - 813mm)
- H: 42" - 54"  
(1067mm - 1372mm)
- D: 23" - 25.5"  
(584mm - 648mm)
- W: 21" (533mm)
- \*SW: 19.2" (488mm)
- \*SD: 18" (457mm)

\* All measurements taken with the BIFMA chair measuring device.

### Features

- Outer Shells: Polypropylene.
- Standard with hard casters; or optional soft casters or glides, see below.
- Mechanism: Swivel with synchronized-tilt.
- Height Adjustment: Pneumatic
- Optional Back-Lock: Lockable in two positions.
- Tilt tension.
- Optional Adjustable Air Lumbar: additional 1.5" (38mm) of lumbar support.
- Forward tilt not available on stools.
- Seat pan can be manually adjusted 3" (76mm).
- Foot ring adjustment: 6.5" - 15" (165mm - 381mm).
- Foot ring available in chrome only; ring support black only; base cover will match trim color.
- COM yardage / COL square footage:  
Polypropylene shell: 1.75/39

### To Order, Specify:

- 1) Product number.
- 2) Fabric surface and color.
- 3) Trim color for shell, arms and base.

Shells	Arms/Caps	Number	Fabric Grade		C	D	E	F	G	H	Leather Grade A	Leather Grade B
			A	B								
<b>Pneumatic Height Adjustment</b>												
Polypropylene		M2E1-1042	\$2650.87	\$2788.55	\$2932.81	\$3004.91	\$3068.21	\$3195.07	\$3310.85	\$3632.11	\$3854.95	\$4184.83
<b>Pneumatic Height Adjustment/Back-Lock</b>												
Polypropylene		M2E1-1041	\$2744.87	\$2882.55	\$3026.81	\$3098.91	\$3162.21	\$3289.07	\$3404.85	\$3726.11	\$3948.95	\$4278.83
<b>Pneumatic Height Adjustment with Adjustable Air Lumbar</b>												
Polypropylene		M2E1-1044	\$2878.16	\$3015.84	\$3160.10	\$3232.20	\$3295.50	\$3422.36	\$3538.14	\$3859.40	\$4082.24	\$4412.12
<b>Pneumatic Height Adjustment/Back-Lock with Adjustable Air Lumbar</b>												
Polypropylene		M2E1-1043	\$2972.16	\$3109.84	\$3254.10	\$3326.20	\$3389.50	\$3516.36	\$3632.14	\$3953.40	\$4176.24	\$4506.12

The following options require modification of the product number.

- |  |   |
|--|---|
| <ul style="list-style-type: none"> <li>Glides</li> <li>Soft casters</li> <li>Faux Leather upholstery</li> <li>Leather upholstery</li> <li>Stain repellent</li> </ul> | <ul style="list-style-type: none"> <li>To specify, change the 7th digit from a 4 to a 0; <b>Example:</b> M2E1-1002</li> <li>To specify, change the 7th digit from a 4 to a 2; <b>Example:</b> M2E1-1022</li> <li>To specify, change the 2nd digit from a 2 to a 3; <b>Example:</b> M3E1-1042</li> <li>To specify, change the 2nd digit from a 2 to a 1; <b>Example:</b> M1E1-1042</li> <li>To specify, add <b>-P</b> to the end of the product number; <b>Example:</b> M2E1-1042-P (add \$69.94 list)</li> </ul> <p><b>NOTE:</b> For available fabrics, refer to <a href="https://surfaces.haworth.com">surfaces.haworth.com</a>.</p> |
|--|---|

# Improv Series

## Leg-Base Stacking Chairs

### With Arms

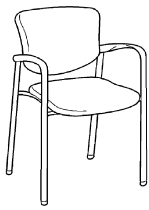

M600-2110

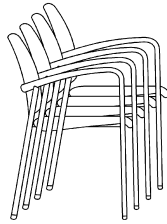

### Dimensions

- \*SH: 18"(457mm)
- H: 32"(813mm)
- D: 21.5"(546mm)
- W: 22"(559mm)
- \*SD: 18"(457mm)
- \*SW: 19"(483mm)
- \*AH: 25.75"(654mm)

\* All measurements taken with the BIFMA chair measuring device.

### Features

- Optional: Full wood back.
- Optional: Legs with casters.
- Polypropylene or upholstered outer back shell.
- With glides, stacks 6-high (44"(1118mm)) on floor or 10-high (62"(1575mm)) on stacking dolly.
- With casters, stacks 5-high (42"(1067mm)) on floor or 6-high (50"(1270mm)) on dolly.
- Arms and molded floor glides match frame color except when ordering Metallic trim; molded components are available in black or smoke and must be specified.
- Non-gangling or gangling options. NOTE: An arm chair adjacent to a tablet arm cannot be gangled together.
- Fire retardant construction is available to comply with California Bulletin #133, see below.
- COM yardage/COL square footage:  
Polypropylene back shell/upholstered seat: 0.75/15  
Upholstered shell/seat: 1.25/28  
Upholstered seat (wood back): 0.5

### To Order, Specify:

- 1) Product number.
- 2) Fabric surface and color.
- 3) Frame/arms trim color.
- 4) Arm and glide trim color for metallic frame black or smoke option only.

### To Order Chair with Wood Back, Specify:

- 1) Product number.
- 2) Fabric surface and color (seat).
- 3) Frame trim color.
- 4) Arm and glide trim color for metallic frame black or smoke option only.
- 5) Wood back finish color.

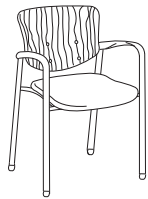

M600-2310

Outer/Inner Back Shell	Gangling	Number	Fabric Grade								Leather Grade A	Leather Grade B
			A	B	C	D	E	F	G	H		
Polypropylene/Upholstered	Non-gangling	M600-2110	\$ 773.48	\$ 827.74	\$ 849.84	\$ 900.08	\$ 946.26	\$1022.56	\$1076.82	\$1225.46	\$1305.84	\$1569.62
	Gangling	M600-2110-5	865.90	920.16	942.26	992.50	1038.68	1114.98	1169.24	1317.88	1398.26	1662.04
Upholstered/Upholstered	Non-gangling	M600-2210	\$ 881.93	\$ 954.31	\$1002.52	\$1072.87	\$1147.14	\$1223.48	\$1285.74	\$1474.58	\$1609.19	\$2021.63
	Gangling	M600-2210-5	974.35	1046.73	1094.94	1165.29	1239.56	1315.90	1378.16	1567.00	1701.61	2114.05
Wood Back	Non-gangling	M600-2310	\$ 966.35	\$1020.61	\$1042.71	\$1092.95	\$1139.13	\$1215.43	\$1269.69	\$1418.33	\$1498.71	\$1762.49
	Gangling	M600-2310-5	1058.77	1113.03	1135.13	1185.37	1231.55	1307.85	1362.11	1510.75	1591.13	1854.91

The following options require modification of the product number.

- Metallic trim color
- Hard casters
- Soft casters
- Stain repellent
- Moisture barrier with stain repellent

- To specify, add **-M** after the 8th digit; **Example:** M600-2110-**M**
- To specify, change the 8th digit from a 0 to a 2; **Example:** M600-2112 (add \$102.44 list)
- To specify, change the 8th digit from a 0 to a 4; **Example:** M600-2114 (add \$161.21 list)
- To specify, add **-P** to the end of the product number; **Example:** M600-2110-**P** (add \$64.30 list)
- To specify, add **-D** to the end of the product number; **Example:** M600-2110-**D** (add \$84.37 list)

**NOTE:** Casters should not be used on thick pile carpet applications.

For available fabrics, refer to [surfaces.haworth.com](http://surfaces.haworth.com).

# Improv Series

## Leg-Base Stacking Chairs

### Without Arms

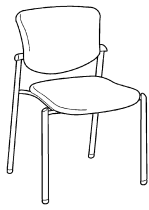

M600-2100

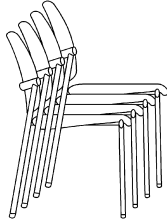

### Dimensions

SH: 18"(457mm)  
 H: 32"(813mm)  
 D: 21.5"(546mm)  
 W: 22"(559mm)  
 SD: 18"(457mm)  
 SW: 19"(483mm)

### Features

- Optional: Full wood back.
- Polypropylene or upholstered outer back shell.
- Stacks 6-high (44"(1118mm)) on floor or 10-high (58"(1473mm)) on stacking dolly.
- High-density polyethylene leg caps and molded floor glides match frame color except when ordering Metallic trim; molded components are available in black or smoke and must be specified.
- Non-gangng or gangng options.
- Fire retardant construction is available to comply with California Bulletin #133, see below.
- COM yardage/COL square footage:  
 Polypropylene back shell/upholstered seat: 0.75/15  
 Upholstered shell/seat: 1.25/28  
 Upholstered seat (wood back): 0.5

### To Order, Specify:

- 1) Product number.
- 2) Fabric surface and color.
- 3) Frame trim color.
- 4) Leg caps and glides color for metallic frame black or smoke option only.

### To Order Chair with Wood Back, Specify:

- 1) Product number.
- 2) Fabric surface and color (seat).
- 3) Frame trim color.
- 4) Leg caps and glides color for metallic frame black or smoke option only.
- 5) Wood back finish color.



M600-2300

Outer/Inner Back Shell	Gangng	Number	Fabric Grade								Leather Grade A	Leather Grade B
			A	B	C	D	E	F	G	H		
Polypropylene/Upholstered	Non-gangng	M600-2100	\$ 727.28	\$ 781.54	\$ 803.64	\$ 853.88	\$ 900.06	\$ 976.36	\$1030.62	\$1179.26	\$1259.64	\$1523.42
	Gangng	M600-2100-5	819.70	873.96	896.06	946.30	992.48	1068.78	1123.04	1271.68	1352.06	1615.84
Upholstered/Upholstered	Non-gangng	M600-2200	\$ 835.73	\$ 908.11	\$ 956.32	\$1026.67	\$1100.94	\$1177.28	\$1239.54	\$1428.38	\$1562.99	\$1975.43
	Gangng	M600-2200-5	928.15	1000.53	1048.74	1119.09	1193.36	1269.70	1331.96	1520.80	1655.41	2067.85
Wood Back	Non-gangng	M600-2300	\$ 920.15	\$ 974.41	\$ 996.51	\$1046.75	\$1092.93	\$1169.23	\$1223.49	\$1372.13	\$1452.51	\$1716.29
	Gangng	M600-2300-5	1012.57	1066.83	1088.93	1139.17	1185.35	1261.65	1315.91	1464.55	1544.93	1808.71

The following options require modification of the product number.

- Metallic trim color
- Stain repellent
- Moisture barrier with stain repellent

To specify, add **-M** after the 8th digit; **Example:** M600-2100-**M**

To specify, add **-P** to the end of the product number; **Example:** M600-2100-**P** (add **\$64.30** list)

To specify, add **-D** to the end of the product number; **Example:** M600-2100-**D** (add **\$84.37** list)

**NOTE:** For available fabrics, refer to [surfaces.haworth.com](https://surfaces.haworth.com).



# Improv Series

## Sled-Base Chairs

### With Arms, Non-Stacking

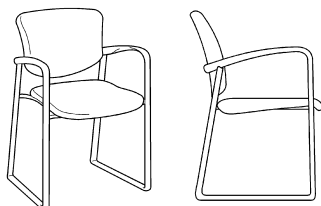

M601-2110

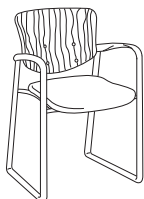

M601-2310

### Dimensions

- SH: 18"(457mm)
- H: 32"(813mm)
- D: 21.5"(546mm)
- W: 22"(559mm)
- SD: 18"(457mm)
- SW: 19"(483mm)
- AH: 25.75"(654mm)

### Features

- Optional: Full wood back.
- Polypropylene or upholstered outer back shell.
- Non-stacking.
- Arms and nylon sled-base runners match frame color except when ordering Metallic trim; molded components are available black or smoke and must be specified.
- Non-gangling or gangling options. NOTE: An arm chair adjacent to a tablet arm cannot be ganged together.
- Fire retardant construction is available to comply with California Bulletin #133, see below.
- COM yardage/COL square footage:  
Polypropylene back shell/upholstered seat: 0.75/15  
Upholstered shell/seat: 1.25/28  
Upholstered seat (wood back): 0.5

### To Order, Specify:

- 1) Product number.
- 2) Fabric surface and color.
- 3) Frame trim color.
- 4) Arm and sled base runners for metallic frame black or smoke option only.

### To Order Chair with Wood Back, Specify:

- 1) Product number.
- 2) Fabric surface and color (seat).
- 3) Frame trim color.
- 4) Arm and sled base runners for metallic frame black or smoke option only.
- 5) Wood back finish color.

Outer/Inner Back Shell	Gangling	Number	Fabric Grade								Leather Grade A	Leather Grade B
			A	B	C	D	E	F	G	H		
Polypropylene/Upholstered	Non-gangling	M601-2110	\$1006.51	\$1060.77	\$1082.87	\$1133.11	\$1179.29	\$1255.59	\$1309.85	\$1458.49	\$1538.87	\$1802.65
	Gangling	M601-2110-5	1098.93	1153.19	1175.29	1225.53	1271.71	1348.01	1402.27	1550.91	1631.29	1895.07
Upholstered/Upholstered	Non-gangling	M601-2210	\$1114.96	\$1187.34	\$1235.55	\$1305.90	\$1380.17	\$1456.51	\$1518.77	\$1707.61	\$1842.22	\$2254.66
	Gangling	M601-2210-5	1207.38	1279.76	1327.97	1398.32	1472.59	1548.93	1611.19	1800.03	1934.64	2347.08
Wood Back	Non-gangling	M601-2310	\$1199.38	\$1253.64	\$1275.74	\$1325.98	\$1372.16	\$1448.46	\$1502.72	\$1651.36	\$1731.74	\$1995.52
	Gangling	M601-2310-5	1291.80	1346.06	1368.16	1418.40	1464.58	1540.88	1595.14	1743.78	1824.16	2087.94

The following options require modification of the product number.

Metallic trim color

Stain repellent

Moisture barrier with stain repellent

To specify, add **-M** after the 8th digit; **Example:** M601-2110-**M**

To specify, add **-P** to the end of the product number; **Example:** M601-2110-**P** (add **\$64.30** list)

To specify, add **-D** to the end of the product number; **Example:** M601-2110-**D** (add **\$84.37** list)

**NOTE:** For available fabrics, refer to [surfaces.haworth.com](http://surfaces.haworth.com).

# Improv Series

## Sled-Base Chairs

### Without Arms, Non-Stacking

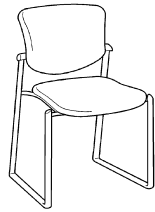

M601-2100

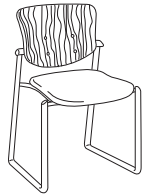
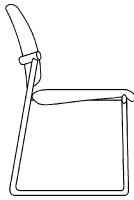

M601-2300

### Dimensions

- SH: 18"(457mm)
- H: 32"(813mm)
- D: 21.5"(546mm)
- W: 22"(559mm)
- SD: 18"(457mm)
- SW: 19"(483mm)

### Features

- Optional: Full wood back.
- Polypropylene or upholstered outer back shell.
- Non-stacking.
- High-density polyethylene leg caps and nylon sled-base runners match frame color except when ordering Metallic trim; molded components are available in black or smoke and must be specified.
- Wood back chairs have four color-matched bolts: black, graphite, smoke and Metallic trim chairs are standard with black bolts, and grey tone and stone chairs are standard with bronze bolts.
- Non-ganging or ganging options.
- Fire retardant construction is available to comply with California Bulletin #133, see below.
- COM yardage/COL square footage:  
Polypropylene back shell/upholstered seat: 0.75/15  
Upholstered back shell/seat: 1.25/28  
Upholstered seat (wood back): 0.5

### To Order, Specify:

- 1) Product number.
- 2) Fabric surface and color.
- 3) Frame trim color.
- 4) Leg caps and sled base runners color for metallic frame black or smoke option only.

### To Order Chair with Wood Back, Specify:

- 1) Product number.
- 2) Fabric surface and color (seat).
- 3) Frame trim color.
- 4) Leg caps and sled base runners color for metallic frame black or smoke option only.
- 5) Wood back finish color.

Outer/Inner Back Shell	Ganging	Number	Fabric Grade								Leather Grade A	Leather Grade B
			A	B	C	D	E	F	G	H		
Polypropylene/Upholstered	Non-ganging	M601-2100	\$ 960.31	\$1014.57	\$1036.67	\$1086.91	\$1133.09	\$1209.39	\$1263.65	\$1412.29	\$1492.67	\$1756.45
	Ganging	M601-2100-5	1052.73	1106.99	1129.09	1179.33	1225.51	1301.81	1356.07	1504.71	1585.09	1848.87
Upholstered/Upholstered	Non-ganging	M601-2200	\$1068.76	\$1141.14	\$1189.35	\$1259.70	\$1333.97	\$1410.31	\$1472.57	\$1661.41	\$1796.02	\$2208.46
	Ganging	M601-2200-5	1161.18	1233.56	1281.77	1352.12	1426.39	1502.73	1564.99	1753.83	1888.44	2300.88
Wood Back	Non-ganging	M601-2300	\$1153.18	\$1207.44	\$1229.54	\$1279.78	\$1325.96	\$1402.26	\$1456.52	\$1605.16	\$1685.54	\$1949.32
	Ganging	M601-2300-5	1245.60	1299.86	1321.96	1372.20	1418.38	1494.68	1548.94	1697.58	1777.96	2041.74

The following options require modification of the product number.

- Metallic trim color
- Stain repellent
- Moisture barrier with stain repellent

- To specify, add **-M** after the 8th digit; **Example:** M601-2100-**M**
- To specify, add **-P** to the end of the product number; **Example:** M601-2100-**P** (add **\$64.30** list)
- To specify, add **-D** to the end of the product number; **Example:** M601-2100-**D** (add **\$84.37** list)

**NOTE:** For available fabrics, refer to [surfaces.haworth.com](https://surfaces.haworth.com).

# Improv Series

Stools

### With Arms

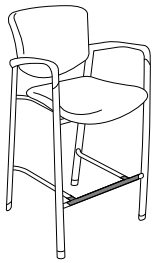

M600-8110



M600-8310

### Dimensions

- SH: 27.5"(699mm)
- H: 41.25"(1048mm)
- D: 23"(584mm)
- W: 22"(559mm)
- SW: 19"(483mm)
- SD: 18"(457mm)
- BW: 18.25"(464mm)
- AH: 35.5"(902mm)
- FH: 10.5"(267mm)

### Features

- Optional: Full wood back.
- Polypropylene or upholstered outer back shell.
- Arms and molded floor glides match frame color except when ordering Metallic trim; molded components are available in black or smoke and must be specified.
- Wood back chairs have four color-matched bolts: black, graphite, smoke and Metallic trim chairs are standard with black bolts, and grey tone, stone and tan chairs are standard with blackened bronze bolts.
- Distance between the arms is 19.25"(489mm).
- Foot rest nylon cover is available in charcoal finish color only.
- Fire retardant construction is available to comply with California Bulletin #133, see below.
- COM yardage/COL square footage:
  - Polypropylene shell: 0.75/15
  - Upholstered shell: 1.25/28
  - Upholstered seat (wood back): 0.5

### To Order, Specify:

- 1) Product number.
- 2) Fabric surface and color.
- 3) Frame trim color.
- 4) Arms and glides color for metallic frame black or smoke option only.

### To Order Stool with Wood Back, Specify:

- 1) Product number.
- 2) Fabric surface and color (seat).
- 3) Frame trim color.
- 4) Arms and glides color for metallic frame black or smoke option only.
- 5) Wood back finish color.

Outer/Inner Back Shell	Number	Fabric Grade		C	D	E	F	G	H	Leather Grade A	Leather Grade B
		A	B								
Polypropylene/Upholstered	M600-8110	\$1358.08	\$1412.34	\$1434.44	\$1484.68	\$1530.86	\$1607.16	\$1661.42	\$1810.06	\$1890.44	\$2154.22
Upholstered/Upholstered	M600-8210	1466.53	1538.91	1587.12	1657.47	1731.74	1808.08	1870.34	2059.18	2193.79	2606.23
Wood Back	M600-8310	1550.95	1605.21	1627.31	1677.55	1723.73	1800.03	1854.29	2002.93	2083.31	2347.09

The following options require modification of the product number.

Metallic trim color

To specify, add **-M** after the 8th digit; **Example:** M600-8110-M

### Without Arms

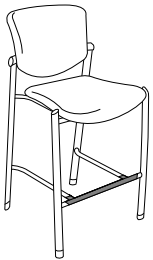

M600-8100

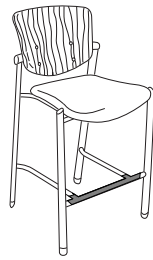

M600-8300

### Dimensions

- SH: 27.5"(699mm)
- H: 41.25"(1048mm)
- D: 23"(584mm)
- W: 22"(559mm)
- SW: 19"(483mm)
- SD: 18"(457mm)
- BW: 18.25"(464mm)
- FH: 10.5"(267mm)

### Features

- Optional: Full wood back.
- Polypropylene or upholstered outer back shell.
- High-density polyethylene leg caps and molded floor glides match frame color except when ordering Metallic trim; molded components are available in black or smoke and must be specified.
- Wood back chairs have four color-matched bolts: black, graphite, smoke and Metallic trim chairs are standard with black bolts, and grey tone, stone and tan chairs are standard with blackened bronze bolts.
- Foot rest nylon cover is available in charcoal finish color only.
- Fire retardant construction is available to comply with California Bulletin #133, see below.
- COM yardage/COL square footage:
  - Polypropylene shell: 0.75/15
  - Upholstered shell: 1.25/28
  - Upholstered seat (wood back): 0.5

### To Order, Specify:

- 1) Product number.
- 2) Fabric surface and color.
- 3) Frame trim color.
- 4) Leg caps and glides color for metallic frame black or smoke option only.

### To Order Stool with Wood Back, Specify:

- 1) Product number.
- 2) Fabric surface and color (seat).
- 3) Frame trim color.
- 4) Leg caps and glides color for metallic frame black or smoke option only.
- 5) Wood back finish color.

Polypropylene/Upholstered	M600-8100	\$1311.88	\$1366.14	\$1388.24	\$1438.48	\$1484.66	\$1560.96	\$1615.22	\$1763.86	\$1844.24	\$2108.02
Upholstered/Upholstered	M600-8200	1420.33	1492.71	1540.92	1611.27	1685.54	1761.88	1824.14	2012.98	2147.59	2560.03
Wood Back	M600-8300	1504.75	1559.01	1581.11	1631.35	1677.53	1753.83	1808.09	1956.73	2037.11	2300.89

The following options require modification of the product number.

Metallic trim color

Stain repellent

Moisture barrier with stain repellent

To specify, add **-M** after the 8th digit; **Example:** M600-8100-M

To specify, add **-P** to the end of the product number; **Example:** M600-8100-P (add **\$64.30** list)

To specify, add **-D** to the end of the product number; **Example:** M600-8100-D (add **\$84.37** list)

**NOTE:** For available fabrics, refer to [surfaces.haworth.com](https://surfaces.haworth.com).

# Improv Series

## Accessories

	Height	Width	Depth	Number	Price
<b>Stacking Dolly</b>	15"(381mm)	24.25"(616mm)	28"(711mm)	MPRV-CART	<b>\$607.31</b>

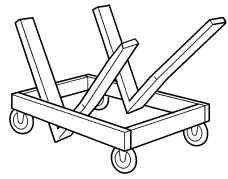

MPRV-CART

### Features

- 3"(76mm) hard rubber casters.
- Recommended stacking limit is 10 chairs high (58"(1473mm) armless, 62"(1575mm) with arms, 6-high on casters (50"(1270mm)).
- Entire depth with chairs stacked is 39.75"(1010mm).
- Standard in black finish color only.
- Ships assembled.

### To Order, Specify:

- 1) Product number.  
(No finish specification required.)

### Chair-to-Chair Connecting Bars

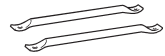

MPRV-BARS

1.25"(32mm)

MPRV-BARS

**\$90.69**

### Features

- Connects two Improv Series chairs side-by-side.
- Width shown is distance between front legs of adjoining chairs.
- Each chair-to-chair connection requires two connecting bars.
- Price includes two (2) bars.

### To Order, Specify:

- 1) Product number.
- 2) Trim color.

To order connecting bars with Metallic trim color add **-M** after eighth digit.

**Example:** MPRV-BARS-**M**

**Improv Series**

## Tandem Seating

**Specification and Ordering Information**

Specify standard Improv Series chair models, and chair-to-chair connecting bars to create a continuous seating configuration.

Use the following guidelines when specifying and ordering Improv seating for tandem configurations:

- 1) Specify the desired chair models from pages 199-202.
  - All chair models are designed to accept chair-to-chair connecting bars.
  - NOTE: It is not necessary to order ganging chair models to create a tandem configuration.
- 2) Specify chair-to-chair connecting bars from page 204.
  - One set of connecting bars will join two chairs in tandem.

**Specification Example**

The following example illustrates a tandem seating configuration.

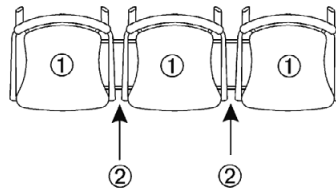

Item	Qty	Number	Description
1	3	M600-2210	Leg-Base Arm Chairs
2	2	MPRV-BARS	Chair-to-Chair Connecting Bars

**Calculating Tandem Seating Dimensions**

Use the following dimensions to determine the footprint of an Improv Series tandem seating configuration.

- 1) All arm and armless chair models are 22"(559mm) wide and 21.5"(546mm) deep.

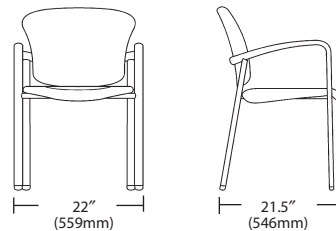

- 2) Add 1.25"(32mm) to the width of the seating run for every chair-to-chair connecting bar.

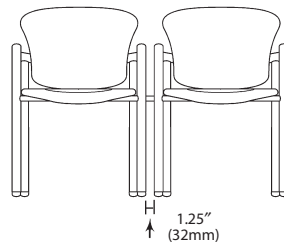

This page intentionally blank

**Features and Options  
(Guest Chair)**

- Upholstered seat
- Soft mesh or upholstered back
- Soft mesh consists of chenille, poly-filament blend
- Black polypropylene arm caps
- Aluminum uprights with welded steel frame
- Finishes include: powder-coated paint (black or silver) and chrome
- Black nylon glides
- Stacks up to 4-high

**Finishes and Fabrics**

A complete listing of finishes and fabrics for **X99** seating is available in the back of the price list.

**Environmental Factors**Material Off Gassing

In an effort to ensure air quality standards, all **X99** parts suppliers are required to provide Material Data Sheets and/or other documentation, verifying their products do not emit volatile organic compounds (VOC). In addition, the powder-coat paint process used in the manufacturing of **X99** seating is free of VOCs. Our manufacturing processes have also eliminated all use of chlorofluorocarbons (CFCs) and ozone depleting chemicals (ODCs) in the chair's construction.

Recycling

All **X99** seating fabric scraps are recycled, reducing the amount of material sent to landfills, and all chair components disassemble easily to increase the potential for recycling. In addition, all thermo-plastic parts are 100% reprocessible, and all raw materials used in its manufacturing can be recycled at the end of the useful life of the product. Recyclable parts are identified with the recycle symbol where practical.

**COM & COL  
General Information**

To order a COM fabric (Customer's Own Material), contact the Haworth Inquiry Center (1.800.426.8562), your local Haworth dealer, or go to [haworth.com/surfaces](http://haworth.com/surfaces) > COM Library to find out if the COM you have selected has already been tested and approved. The surface collection site also has information on the Haworth+ alliance program with Carnegie, Luna Textiles, and Maharam as well as our industry-leading Pre-Approved COM program.

COM fabrics are placed into Grades based on the cost per linear yard. If a fabric's cost exceeds the range of our highest Grade it will be noted as Non-Graded. The product will be priced at Grade A; the COM fabric costs will appear as a separate line item. The fabric charge will be Haworth's purchase cost plus a 4% administrative fee (based on the cost of the fabric). Yardage calculations will include any applicable fabric repeat.

COM Leather products will be priced at a leather Grade A; COL costs will appear as a separate line item. The leather costs will be Haworth's purchase cost plus a 4% administrative fee (based on the cost of the leather).

**Shipping Weights  
(including packaging)**

- Guest chair with sled base: 35 pounds/1 chair per carton/19.5 cubic feet
- Seminar chair: 34 pounds/1 chair per carton/18.7 cubic feet
- Advanced Seminar chair: 40 pounds/1 chair per carton/16.0 cubic feet

# X99

## General Specifications

### General Guidelines for Product Specification

	X	6	4	0	-	0	1	4	0	,	3A-18	,	M0-BL	TR-LE
Product Line	_____													
(X) X99	_____													
Back Material	_____													
(6) Mesh	_____													
(8) Upholstered	_____													
Chair Model	_____													
(3) Guest	_____													
(4) Seminar	_____													
Height Adjustment	_____													
(0) Fixed Height	_____													
(1) Height Adjustable	_____													
Base	_____													
(0) Four Leg	_____													
(2) Five-Star	_____													
(3) Sled Base	_____													
Arms	_____													
(0) No Arms	_____													
(1) Fixed Arms	_____													
Casters	_____													
(0) Glides	_____													
(4) Casters	_____													
Lumbar Option	_____													
(0) No Lumbar	_____													
Seat Upholstery	_____													
Tellure	_____													
Back Mesh	_____													
Mesh	_____													
Frame Color	_____													
Trim Color	_____													



# X99

## Guest Chair



X630-3100

**Dimensions\***

- \*SH: 18”(457mm)
- H: 36”(914)
- D: 24”(610mm)
- W: 22”(559mm)
- \*SW: 19”(483mm)
- \*SD: 18”(457mm)
- \*AH: 8”(203mm)

\* All measurements taken with the BIFMA chair measuring device.

**Features**

- Back: Soft mesh or upholstered.
- Seat: Standard upholstered.
- Arms: Black polypropylene arm caps.
- Black glides only.
- Aluminum uprights with welded steel frame.
- COM yardage / COL square footage:  
 Mesh back model: 0.5/15  
 Fully upholstered model: 1.4/25

**To Order, Specify:**

- 1) Product number.
- 2) Fabric surface and color (seat).
- 3) Fabric or mesh surface and color (back).
- 4) Trim color for frame.  
 (Add **\$306.19** for chrome finish.)

Seat	Back	Arm Caps	Number	Fabric Grade								Leather Grade A	Leather Grade B
				A	B	C	D	E	F	G	H		
Upholstered	Mesh	Standard	X630-3100	\$1525.52	\$1585.31	\$1643.28	\$1674.04	\$1697.65	\$1750.18	\$1799.10	\$1933.17	\$2025.56	\$2264.03
Upholstered	Upholstered	Standard	X830-3100	1641.49	1761.07	1877.01	1938.53	1985.75	2090.81	2188.65	2456.79	2641.57	3118.51

The following options require modification of the product number.

- Stain Repellent To specify, add **-P** to end of the product number; **Example:** X630-3100-**P** (add **\$57.96** list)
- Moisture Barrier with Stain repellent To specify, add **-D** to end of the product number; **Example:** X630-3100-**D** (add **\$76.07** list)
- Leather Seat and Mesh Back To specify, change the 2nd digit in mesh back model to **5**; **Example:** X**5**30-3100
- Leather Seat and Leather Back To specify, change the 2nd digit in upholstered back model to **7**; **Example:** X**7**30-3100

**NOTE:** For available fabrics, refer to [surfaces.haworth.com](http://surfaces.haworth.com).

# X99

## Seminar Chair

### With Arms



X640-0140

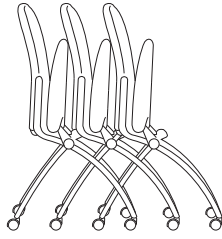

### Dimensions\*

- \*SH: 19"(483mm)
- H: 36"(914mm)
- D: 24"(610mm)
- W: 22"(559mm)
- \*SW: 19"(483mm)
- \*SD: 18"(457mm)
- \*AH: 8"(203mm)

\* All measurements taken with the BIFMA chair measuring device.

### Features

- Back: Soft mesh or upholstered.
- Seat: Standard upholstered, with folding seat.
- Arms: Black polypropylene arm caps.
- Casters: Standard with hard casters; or optional soft casters, see below.
- Optional black glides, see below.
- Aluminum uprights with welded steel frame.
- Each nested chair adds 7.5"(191mm) of floor space.
- COM yardage / COL square footage:  
Mesh back model: 0.5/15  
Fully upholstered model: 1.4/25
- Casters shipped unassembled.

### To Order, Specify:

- 1) Product number.
- 2) Fabric surface and color (seat).
- 3) Fabric or mesh surface and color (back).
- 4) Trim color for frame.  
(Add **\$516.34** for chrome finish.)

Seat	Back	Arm Caps	Number	Fabric Grade								Leather Grade A	Leather Grade B
				A	B	C	D	E	F	G	H		
Upholstered	Mesh	Standard	X640-0140	\$1467.50	\$1527.29	\$1585.26	\$1616.02	\$1639.63	\$1692.16	\$1741.08	\$1875.15	\$1967.54	\$2206.01
Upholstered	Upholstered	Standard	X840-0140	1583.47	1703.05	1818.99	1880.51	1927.73	2032.79	2130.63	2398.77	2583.55	3060.49

The following options require modification of the product number.

- Soft Caster  
To specify, change the 7th digit from a 4 (hard caster) to a 2 (soft caster); **Example:** X640-0120 (add **\$62.58** list)
- Glide  
To specify, change the 7th digit from a 4 (hard caster) to a 0; **Example:** X640-0100
- Stain Repellent  
To specify, add **-P** to end of the product number; **Example:** X640-0140-**P** (add **\$57.96** list)
- Moisture Barrier with Stain Repellent  
To specify, add **-D** to end of the product number; **Example:** X640-0140-**D** (add **\$76.07** list)
- Leather Seat and Mesh Back  
To specify, change the 2nd digit in mesh back model to 5; **Example:** X540-0140
- Leather Seat and Leather Back  
To specify, change the 2nd digit in upholstered back model to 7; **Example:** X740-0140

# X99

## Seminar Chair

**Without Arms**



X640-0040

**Dimensions\***

- \*SH: 18”(457mm)
- H: 36”(914mm)
- D: 24”(610mm)
- W: 22”(559mm)
- \*SW: 19”(483mm)
- \*SD: 18”(457mm)

\* All measurements taken with the BIFMA chair measuring device.

**Features**

- Back: Soft mesh or upholstered.
- Seat: Standard upholstered, with folding seat.
- Casters: Standard with hard casters; or optional soft casters, see below.
- Optional black glides, see below.
- Aluminum uprights with welded steel frame.
- COM yardage / COL square footage:  
 Mesh back model: 0.5/15  
 Fully upholstered model: 1.4/25
- Casters shipped unassembled.

**To Order, Specify:**

- 1) Product number.
- 2) Fabric surface and color (seat).
- 3) Fabric surface and color (back). (Specify M0-BL for mesh back).
- 4) Trim color for frame. (Add **\$516.34** for chrome finish.)

Seat	Back	Number	Fabric Grade								Leather Grade A	Leather Grade B
			A	B	C	D	E	F	G	H		
Upholstered	Mesh	X640-0040	\$1373.28	\$1433.07	\$1491.04	\$1521.80	\$1545.41	\$1597.94	\$1646.86	\$1780.93	\$1873.32	\$2111.79
Upholstered	Upholstered	X840-0040	1489.25	1608.83	1724.77	1786.29	1833.51	1938.57	2036.41	2304.55	2489.33	2966.27

The following options require modification of the product number.

- Soft Caster  
 To specify, change the 7th digit from a **4** (hard caster) to a **2** (soft caster); **Example:** X640-0020 (add **\$62.58** list)
- Glide  
 To specify, change the 7th digit from a **4** (hard caster) to a **0**; **Example:** X640-0000
- Stain repellent  
 To specify, add **-P** to end of the product number; **Example:** X640-0040-**P** (add **\$57.96** list)
- Moisture Barrier with Stain Repellent  
 To specify, add **-D** to end of the product number; **Example:** X640-0040-**D** (add **\$76.07** list)
- Leather Seat and Mesh Back  
 To specify, change the 2nd digit in mesh back model to **5**; **Example:** X540-0040
- Leather Seat and Leather Back  
 To specify, change the 2nd digit in upholstered back model to **7**; **Example:** X740-0040

**NOTE:** For available fabrics, refer to [surfaces.haworth.com](http://surfaces.haworth.com).

# X99

## Advanced Seminar Chair

### With Arms



X641-2140

### Dimensions\*

- \*SH: 16" - 21"  
(406mm - 533mm)
- H: 33.5" - 38.5"  
(851mm - 978mm)
- D: 26.5"(673mm)
- W: 26.5"(673mm)
- \*SW: 18.5"(470mm)
- \*SD: 16"(406mm)
- \*AH: 8"(203mm)

\* All measurements taken with the BIFMA chair measuring device.

### Features

- Back: Soft mesh or upholstered.
- Seat: Standard upholstered.
- Arms: Black polypropylene arm caps.
- Base: Five-star aluminum base.
- Pneumatic seat height adjustment range 16"(406mm)-21"(533mm).
- Casters: Standard with hard casters; or optional soft casters, see below.
- Back tilts backward 21° from the upright position.
- Optional chrome finish chairs are standard with chrome base, uprights and back crossbar.
- COM yardage / COL square footage:  
Mesh back model: 0.5/15  
Fully upholstered model: 1.4/25

### To Order, Specify:

- 1) Product number.
- 2) Fabric surface and color (seat).
- 3) Fabric or mesh surface and color (back).
- 4) Trim color for frame. (Add **\$516.34** for chrome finish.)

Seat	Back	Arm Caps	Number	Fabric Grade								Leather Grade A	Leather Grade B
				A	B	C	D	E	F	G	H		
Upholstered	Mesh	Standard	X641-2140	\$1701.24	\$1761.03	\$1819.00	\$1849.76	\$1873.37	\$1925.90	\$1974.82	\$2108.89	\$2201.28	\$2439.75
Upholstered	Upholstered	Standard	X841-2140	1817.21	1936.79	2052.73	2114.25	2161.47	2266.53	2364.37	2632.51	2817.29	3294.23

The following options require modification of the product number.

- Soft Caster To specify, change the 7th digit from a **4** (hard caster) to a **2** (soft caster); **Example:** X641-2120 (add **\$62.58** list)
- Leather Seat and Mesh Back To specify, change the 2nd digit in mesh back model to **5**; **Example:** X541-2140
- Leather Seat and Leather Back To specify, change the 2nd digit in upholstered back model to **7**; **Example:** X741-2140

# X99

## Advanced Seminar Chair

**Without Arms**



X641-2040

**Dimensions\***

- \*SH: 16" - 21"  
(406mm - 533mm)
- H: 33.5" - 38.5"  
(851mm - 978mm)
- D: 26.5"(673mm)
- W: 26.5"(673mm)
- \*SW: 18.5"(470mm)
- \*SD: 16"(406mm)

\* All measurements taken with the BIFMA chair measuring device.

**Features**

- Back: Soft mesh or upholstered.
- Seat: Standard upholstered.
- Base: Five-star aluminum base.
- Pneumatic seat height adjustment range 16"(406mm)-21"(533mm).
- Casters: Standard with hard casters; or optional soft casters, see below.
- Back tilts backward 21° from the upright position.
- Optional chrome finish chairs are standard with chrome base, uprights and back crossbar.
- COM yardage / COL square footage:  
Mesh back model: 0.5/15  
Fully upholstered model: 1.4/25

**To Order, Specify:**

- 1) Product number.
- 2) Fabric surface and color (seat).
- 3) Fabric surface and color (back).
- 4) Trim color for frame. (Add **\$516.34** for chrome finish.)

Seat	Back	Number	Fabric Grade							Leather Grade A	Leather Grade B	
			A	B	C	D	E	F	G			H
Upholstered	Mesh	X641-2040	\$1608.83	\$1668.62	\$1726.59	\$1757.35	\$1780.96	\$1833.49	\$1882.41	\$2016.48	\$2108.87	\$2347.34
Upholstered	Upholstered	X841-2040	1724.80	1844.38	1960.32	2021.84	2069.06	2174.12	2271.96	2540.10	2724.88	3201.82

The following options require modification of the product number.

- Soft Caster To specify, change the 7th digit from a **4** (hard caster) to a **2** (soft caster); **Example:** X641-2020 (add **\$62.58** list)
- Stain repellent To specify, add **-P** to end of the product number; **Example:** X641-2040-**P** (add **\$57.96** list)
- Leather Seat and Mesh Back To specify, change the 2nd digit in mesh back model to **5**; **Example:** X541-2040
- Leather Seat and Leather Back To specify, change the 2nd digit in upholstered back model to **7**; **Example:** X741-2040

**NOTE:** For available fabrics, refer to [surfaces.haworth.com](http://surfaces.haworth.com).

This page intentionally blank

# Maari

## General Specifications

<b>Designer</b>	Patricia Urquiola
<b>Maari</b>	The Maari family of seating offers numerous functional combinations in one, broad chair line to specify in almost any setting. The statement of line is rooted in a one-piece, textured, molded shell that is the same for all chairs for simplicity of specification.
<b>Awards</b>	2018 Interior Design Best of Year winner.
<b>Features and Options</b>	<ul style="list-style-type: none"> <li>• High-strength polymer shell can be retrofitted from one base to another including from chair to stool.</li> <li>• Available in standard seat height, counter height and bar height.</li> <li>• Optional upholstered seat pad or seat and back pad option available.</li> <li>• Options include: <ul style="list-style-type: none"> <li>-Sled Base Chair and Stools <ul style="list-style-type: none"> <li>Chair and Stools available with plastic or felt glides.</li> <li>Chair available arm or armless. Stool available as armless only.</li> <li>Chairs stack 5 high on the floor and 8 high upholstered or 16 high non-upholstered on the Very wire stacker cart.</li> </ul> </li> <li>-Four-Leg Chair and Stools <ul style="list-style-type: none"> <li>Chair and Stools available with plastic or felt glides. Chair also available with hard or soft casters.</li> <li>Chair and Stools available arm or armless.</li> <li>Chairs stack 5 high on the floor.</li> </ul> </li> <li>-Wood-Leg Chair and Stools <ul style="list-style-type: none"> <li>Chair and Stools available with plastic or felt glides.</li> <li>Chair and Stools available as armless only.</li> <li>Wood-Leg chair does not stack.</li> </ul> </li> <li>-Four-Star Base Chair <ul style="list-style-type: none"> <li>Fixed height chair. Stool not available.</li> <li>Available with plastic or felt glides.</li> <li>Seat swivels 360°.</li> </ul> </li> <li>-Five-Star Base Chair <ul style="list-style-type: none"> <li>Height adjustable chair. Stool not available.</li> <li>Available with hard or soft casters.</li> <li>Available arm or armless.</li> <li>Tablet arm option available in painted MDF, Laminate or Wood.</li> </ul> </li> </ul> </li> </ul>

# Maari

## General Specifications

### General Guidelines for Product Specification

	S	7	S - 2	4 - 1	H	R	L
Product Type	_____		_____	_____	_____	_____	_____
(S) Seating	_____		_____	_____	_____	_____	_____
Product Line	_____		_____	_____	_____	_____	_____
(7) Maari - Standard Back	_____		_____	_____	_____	_____	_____
(8) Maari - Low Back	_____		_____	_____	_____	_____	_____
Model	_____		_____	_____	_____	_____	_____
Chairs	_____		_____	_____	_____	_____	_____
(H) Sled Base	_____		_____	_____	_____	_____	_____
(S) Four-Leg	_____		_____	_____	_____	_____	_____
(W) Wood-Leg	_____		_____	_____	_____	_____	_____
(4) 4-Star Base	_____		_____	_____	_____	_____	_____
(5) 5-Star Base	_____		_____	_____	_____	_____	_____
Stools	_____		_____	_____	_____	_____	_____
(HC) Sled Base - Counter Height	_____		_____	_____	_____	_____	_____
(HB) Sled Base - Bar Height	_____		_____	_____	_____	_____	_____
(SC) Four-Leg - Counter Height	_____		_____	_____	_____	_____	_____
(SB) Four-Leg - Bar Height	_____		_____	_____	_____	_____	_____
(WC) Wood-Leg - Counter Height	_____		_____	_____	_____	_____	_____
(WB) Wood-Leg - Bar Height	_____		_____	_____	_____	_____	_____
Seat Material	_____		_____	_____	_____	_____	_____
(1) Leather	_____		_____	_____	_____	_____	_____
(2) Fabric	_____		_____	_____	_____	_____	_____
(3) Faux Leather	_____		_____	_____	_____	_____	_____
(4) Polymer	_____		_____	_____	_____	_____	_____
Back Material	_____		_____	_____	_____	_____	_____
(1) Leather	_____		_____	_____	_____	_____	_____
(2) Fabric	_____		_____	_____	_____	_____	_____
(3) Faux Leather	_____		_____	_____	_____	_____	_____
(4) Polymer	_____		_____	_____	_____	_____	_____
Arms	_____		_____	_____	_____	_____	_____
(0) No Arms	_____		_____	_____	_____	_____	_____
(1) Fixed Arms, Hard Caps	_____		_____	_____	_____	_____	_____
Base/Caster	_____		_____	_____	_____	_____	_____
(H) Plastic Glides (Sled Base, Four-Leg, Wood-Leg, 4-Star chairs and all stools)	_____		_____	_____	_____	_____	_____
(K) Felt Glides (Sled Base, Four-Leg, Wood-Leg, 4-Star chairs and all stools)	_____		_____	_____	_____	_____	_____
(1) Hard Casters (Four-Leg and 5-Star chairs) - Black, Smooth Plaster	_____		_____	_____	_____	_____	_____
(2) Soft Casters (Four-Leg and 5-Star chairs) - Black only	_____		_____	_____	_____	_____	_____
(T) Two-Tone Caster (Four-Leg chair)	_____		_____	_____	_____	_____	_____
Tablet Handedness (if applicable - 5 Star base only)	_____		_____	_____	_____	_____	_____
(R) Right Hand	_____		_____	_____	_____	_____	_____
(L) Left Hand	_____		_____	_____	_____	_____	_____
Tablet Surface (if applicable)	_____		_____	_____	_____	_____	_____
(P) Painted MDF	_____		_____	_____	_____	_____	_____
(L) Laminate	_____		_____	_____	_____	_____	_____
(W) Wood	_____		_____	_____	_____	_____	_____



# Maari

Sled Base Chair

**With Arms**



S7H-44-1H



S7H-24-1H



S7H-22-1H

**Dimensions**

- \*SH: 18"(457mm)
- H: 33.75"(857mm)
- D: 21.75"(552mm)
- W: 25.25"(641mm)
- \*SW: 18.5"(470mm)
- \*SD: 16.75"(425mm)
- \*AH: 8.5"(216mm)
- Between Arms: 22"(559mm)

\* All measurements taken with the BIFMA chair measuring device.

**Features**

- Seat: High-strength polymer shell with optional upholstered seat pad.
- Back: High-strength polymer shell with optional upholstered back pad.
- Base: Available painted or chrome.
- Arm caps: Polypropylene.
- Glides: Plastic or felt.
- Stacks 5 high on the floor and 8 high upholstered or 16 high non-upholstered on the Very wire stacker cart.
- COM yardage / COL square footage:  
Seat: 0.75/6.75  
Back: 0.75/6.75

**Specification Tip**

- To stack on cart, use Very wire stacker cart.

**To Order, Specify:**

1) Product number, including:

**1 Seat Surface:**

- 1 Leather
- 2 Fabric
- 3 Faux Leather
- 4 Polymer

**2 Back Surface:**

- 1 Leather
- 2 Fabric
- 3 Faux Leather
- 4 Polymer

**3 Glide Option:**

- H Plastic Glides
- K Felt Glides

- 2) Shell color (required for upholstered and non-upholstered).
- 3) Seat upholstery and color (if applicable).
- 4) Back upholstery and color (if applicable).
- 5) Base trim color.  
Add **\$82.27** list for Smooth Plaster & Matte finish.
- 6) Trim color for arm caps.

Number ① ② ③	Price	Fabric Grade										Leather Grade A	Leather Grade B
		A	B	C	D	E	F	G	H				
<b>Without Optional Upholstered Pad</b>													
S7H- 4 4 -1	\$537.05	N/A	N/A	N/A	N/A	N/A	N/A	N/A	N/A	N/A	N/A	N/A	N/A
<b>With Upholstered Seat Pad</b>													
S7H- 4 4 -1	N/A	\$702.28	\$725.69	\$736.71	\$761.51	\$ 778.04	\$ 853.78	\$ 901.97	\$ 980.47	\$ 862.01	\$1061.71		
<b>With Upholstered Seat and Back Pad</b>													
S7H- 4 4 -1	N/A	\$867.51	\$914.33	\$936.37	\$985.97	\$1019.03	\$1170.51	\$1266.89	\$1423.89	\$1186.97	\$1586.37		

The following options require modification of the product number.

Stain repellent

To specify, add **P** to the end of the product number; **Example:** S7H-24-1HP (add **\$55.85** list)

**NOTE:** Stain repellent is available on fabric surfaces only.

# Maari

## Sled Base Chair

### Without Arms



S7H-44-0H



S7H-24-0H



S7H-22-0H

### Dimensions

- \*SH: 18"(457mm)
- H: 33.75"(857mm)
- D: 21.75"(552mm)
- W: 22"(559mm)
- \*SW: 18.5"(470mm)
- \*SD: 16.75"(425mm)

\* All measurements taken with the BIFMA chair measuring device.

### Features

- Seat: High-strength polymer shell with optional upholstered seat pad.
- Back: High-strength polymer shell with optional upholstered back pad.
- Base: Available painted or chrome.
- Glides: Plastic or felt.
- Stacks 5 high on the floor and 8 high upholstered or 16 high non-upholstered on the Very wire stacker cart.
- COM yardage / COL square footage:  
Seat: 0.75/6.75  
Back: 0.75/6.75

### Specification Tip

- To stack on cart, use Very wire stacker cart.

### To Order, Specify:

- 1) Product number, including:

#### 1 Seat Surface:

- 1 Leather
- 2 Fabric
- 3 Faux Leather
- 4 Polymer

#### 2 Back Surface:

- 1 Leather
- 2 Fabric
- 3 Faux Leather
- 4 Polymer

#### 3 Glide Option:

- H Plastic Glides
- K Felt Glides

- 2) Shell color (required for upholstered and non-upholstered).
- 3) Seat upholstery and color (if applicable).
- 4) Back upholstery and color (if applicable).
- 5) Base trim color.  
Add **\$82.27** list for Smooth Plaster & Matte finish.

Number ① ② ③	Price	Fabric Grade		C	D	E	F	G	H	Leather Grade A	Leather Grade B
		A	B								
<b>Without Optional Upholstered Pad</b>											
S7H- 4 4 -0	\$447.54	N/A	N/A	N/A	N/A	N/A	N/A	N/A	N/A	N/A	N/A
<b>With Upholstered Seat Pad</b>											
S7H- 4 -0	N/A	\$612.77	\$636.18	\$647.20	\$672.00	\$688.53	\$ 764.27	\$ 812.46	\$ 890.96	\$ 772.50	\$ 972.20
<b>With Upholstered Seat and Back Pad</b>											
S7H- -0	N/A	\$778.00	\$824.82	\$846.86	\$896.46	\$929.52	\$1081.00	\$1177.38	\$1334.38	\$1097.46	\$1496.86

The following options require modification of the product number.

Stain repellent

To specify, add **P** to the end of the product number; **Example:** S7H-24-0HP (add **\$55.85** list)

**NOTE:** Stain repellent is available on fabric surfaces only.

# Maari

## Four-Leg Chair

**With Arms**

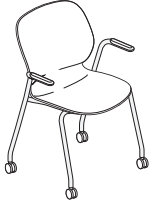

S75-44-11

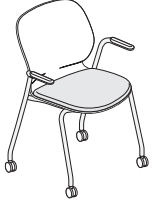

S75-24-11

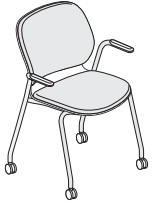

S75-22-11

**Dimensions**

- \*SH: 18"(457mm)
- H: 33"(838mm)
- D: 21.5"(546mm)
- W: 25.5"(648mm)
- \*SW: 18.5"(470mm)
- \*SD: 16.75"(425mm)
- \*AH: 8.5"(216mm)
- Between Arms: 21.8"(554mm)

\* All measurements taken with the BIFMA chair measuring device.

**Features**

- Seat: High-strength polymer shell with optional upholstered seat pad.
- Back: High-strength polymer shell with optional upholstered back pad.
- Arm caps: Polypropylene.
- Base: Four-Leg base available with glides or casters.
- Glides: Plastic or felt.
- Casters: Hard casters available in Black or Smooth Plaster. Color received is determined by frame color. Soft casters available in Black only. Exception: Specified Two-Tone casters in Fog.
- Stacks 5 high on the floor.
- COM yardage / COL square footage:  
Seat: 0.75/6.75  
Back: 0.75/6.75

**To Order, Specify:**

1) Product number, including:

**1 Seat Surface:**

- 1 Leather
- 2 Fabric
- 3 Faux Leather
- 4 Polymer

**2 Back Surface:**

- 1 Leather
- 2 Fabric
- 3 Faux Leather
- 4 Polymer

**3 Glide or Caster Option:**

- H Plastic Glides
- K Felt Glides
- 1 Hard Casters, add **\$55.85** list
- 2 Soft Casters, add **\$118.67** list
- T Two-Tone Casters, add **\$55.85** list

- 2) Shell color (required for upholstered and non-upholstered).
- 3) Seat upholstery and color (if applicable).
- 4) Back upholstery and color (if applicable).
- 5) Base trim color. Add **\$82.27** list for Smooth Plaster & Matte finish.
- 6) Trim color for arm caps.

Number 1 2 3	Price	Fabric Grade										Leather Grade A	Leather Grade B
		A	B	C	D	E	F	G	H				
<b>Without Optional Upholstered Pad</b>													
S75- 4 4 -1	\$550.82	N/A	N/A	N/A	N/A	N/A	N/A	N/A	N/A	N/A	N/A	N/A	N/A
<b>With Upholstered Seat Pad</b>													
S75- 4 -1	N/A	\$716.05	\$739.46	\$750.48	\$775.28	\$ 791.81	\$ 867.55	\$ 915.74	\$ 994.24	\$ 875.78	\$1075.48		
<b>With Upholstered Seat and Back Pad</b>													
S75- -1	N/A	\$881.28	\$928.10	\$950.14	\$999.74	\$1032.80	\$1184.28	\$1280.66	\$1437.66	\$1200.74	\$1600.14		

The following options require modification of the product number.

Stain repellent

To specify, add **P** to the end of the product number; **Example:** S75-24-1HP (add **\$55.85** list)

**NOTE:** Stain repellent is available on fabric surfaces only.

# Maari

## Four-Leg Chair

### Without Arms



S7S-44-0H



S7S-24-0H



S7S-22-0H

### Dimensions

- \*SH: 18"(457mm)
- H: 33"(838mm)
- D: 21.5"(546mm)
- W: 23"(584mm)
- \*SW: 18.5"(470mm)
- \*SD: 16.75"(425mm)

\* All measurements taken with the BIFMA chair measuring device.

### Features

- Seat: High-strength polymer shell with optional upholstered seat pad.
- Back: High-strength polymer shell with optional upholstered back pad.
- Base: Four-Leg base available with glides or casters.
- Glides: Plastic or felt.
- Casters: Hard casters available in Black or Smooth Plaster. Color received is determined by frame color. Soft casters available in Black only. Exception: Specified Two-Tone casters in Fog.
- Stack 5 high on the floor.
- COM yardage / COL square footage:  
Seat: 0.75/6.75  
Back: 0.75/6.75

### To Order, Specify:

1) Product number, including:

#### 1 Seat Surface:

- 1 Leather
- 2 Fabric
- 3 Faux Leather
- 4 Polymer

#### 2 Back Surface:

- 1 Leather
- 2 Fabric
- 3 Faux Leather
- 4 Polymer

#### 3 Glide or Caster Option:

- H Plastic Glides
- K Felt Glides
- 1 Hard Casters, add **\$55.85** list
- 2 Soft Casters, add **\$118.67** list
- T Two-Tone Casters, add **\$55.85** list

- 2) Shell color (required for upholstered and non-upholstered).
- 3) Seat upholstery and color (if applicable).
- 4) Back upholstery and color (if applicable).
- 5) Base trim color.  
Add **\$82.27** list for Smooth Plaster & Matte finish.

Number ①②③	Price	Fabric Grade								Leather Grade A	Leather Grade B	
		A	B	C	D	E	F	G	H			
<b>Without Optional Upholstered Pad</b>												
S7S- 4 4 -0	\$461.31	N/A	N/A	N/A	N/A	N/A	N/A	N/A	N/A	N/A	N/A	N/A
<b>With Upholstered Seat Pad</b>												
S7S- 4 -0	N/A	\$626.54	\$649.95	\$660.97	\$685.77	\$702.30	\$ 778.04	\$ 826.23	\$ 904.73	\$ 786.27	\$ 985.97	
<b>With Upholstered Seat and Back Pad</b>												
S7S- -0	N/A	\$791.77	\$838.59	\$860.63	\$910.23	\$943.29	\$1094.77	\$1191.15	\$1348.15	\$1111.23	\$1510.63	

The following options require modification of the product number.

Stain repellent

To specify, add **P** to the end of the product number; **Example:** S7S-24-0HP (add **\$55.85** list)

**NOTE:** Stain repellent is available on fabric surfaces only.

# Maari

Wood-Leg Chair

**Without Arms**



S7W-44-0H



S7W-24-0H



S7W-22-0H

**Dimensions**

- \*SH: 18"(457mm)
- H: 34"(864mm)
- D: 21.5"(546mm)
- W: 19.5"(495mm)
- \*SW: 18.5"(470mm)
- \*SD: 16.75"(425mm)

\* All measurements taken with the BIFMA chair measuring device.

**Features**

- Seat: High-strength polymer shell with optional upholstered seat pad.
- Back: High-strength polymer shell with optional upholstered back pad.
- Base: Four leg wooden base.
- Glides: Plastic or felt.
- Chair only available without arms.
- Wood-Leg Chair does not stack.
- COM yardage / COL square footage:  
Seat: 0.75/6.75  
Back: 0.75/6.75

**To Order, Specify:**

1) Product number, including:

**1 Seat Surface:**

- 1 Leather
- 2 Fabric
- 3 Faux Leather
- 4 Polymer

**2 Back Surface:**

- 1 Leather
- 2 Fabric
- 3 Faux Leather
- 4 Polymer

**3 Glide Option:**

- H Plastic Glides
- K Felt Glides

- 2) Shell color (required for upholstered and non-upholstered).
- 3) Seat upholstery and color (if applicable).
- 4) Back upholstery and color (if applicable).
- 5) Wood finish.

Number ① ② ③	Price	Fabric Grade										Leather Grade A	Leather Grade B
		A	B	C	D	E	F	G	H				
<b>Without Optional Upholstered Pad</b>													
S7W- 4 4 -0	\$1066.20	N/A	N/A	N/A	N/A	N/A	N/A	N/A	N/A	N/A	N/A	N/A	N/A
<b>With Upholstered Seat Pad</b>													
S7W- 4 4 -0	N/A	\$1231.43	\$1254.84	\$1265.86	\$1290.66	\$1307.19	\$1382.93	\$1431.12	\$1509.62	\$1391.16	\$1590.86		
<b>With Upholstered Seat and Back Pad</b>													
S7W- 4 4 -0	N/A	\$1396.66	\$1443.48	\$1465.52	\$1515.12	\$1548.18	\$1699.66	\$1796.04	\$1953.04	\$1716.12	\$2115.52		

The following options require modification of the product number.

Stain repellent

To specify, add **P** to the end of the product number; **Example:** S7W-24-0HP (add \$55.85 list)

**NOTE:** Stain repellent is available on fabric surfaces only.

# Maari

## Four-Star Base Chair

### With Arms



S74-44-1H



S74-24-1H



S74-22-1H

### Dimensions

- \*SH: 18"(457mm)
- H: 34"(864mm)
- D: 25.5"(648mm)
- W: 25.5"(648mm)
- \*SW: 18.5"(470mm)
- \*SD: 16.75"(425mm)
- \*AH: 8.5"(216mm)
- Between Arms: 21.5"(546mm)

\* All measurements taken with the BIFMA chair measuring device.

### Features

- Seat: High-strength polymer shell with optional upholstered seat pad.
- Back: High-strength polymer shell with optional upholstered back pad.
- Arm caps: Polypropylene.
- Base: Fixed height four-star base with glides.
- Glides: Plastic or felt.
- Seat swivels 360°.
- COM yardage / COL square footage:  
Seat: 0.75/6.75  
Back: 0.75/6.75

### To Order, Specify:

1) Product number, including:

#### 1 Seat Surface:

- 1 Leather
- 2 Fabric
- 3 Faux Leather
- 4 Polymer

#### 2 Back Surface:

- 1 Leather
- 2 Fabric
- 3 Faux Leather
- 4 Polymer

#### 3 Glide Option:

- H Plastic Glides
- K Felt Glides

2) Shell color (required for upholstered and non-upholstered).

3) Seat upholstery and color (if applicable).

4) Back upholstery and color (if applicable).

5) Base trim color.  
Add **\$82.27** list for Smooth Plaster & Matte finish.

6) Trim color for arm caps.

Number ① ② ③	Price	Fabric Grade								Leather Grade A	Leather Grade B	
		A	B	C	D	E	F	G	H			
<b>Without Optional Upholstered Pad</b>												
S74- 4 4 -1	\$876.31	N/A	N/A	N/A	N/A	N/A	N/A	N/A	N/A	N/A	N/A	N/A
<b>With Upholstered Seat Pad</b>												
S74- 4 4 -1	N/A	\$1041.54	\$1064.95	\$1075.97	\$1100.77	\$1117.30	\$1193.04	\$1241.23	\$1319.73	\$1201.27	\$1400.97	
<b>With Upholstered Seat and Back Pad</b>												
S74- 4 4 -1	N/A	\$1206.77	\$1253.59	\$1275.63	\$1325.23	\$1358.29	\$1509.77	\$1606.15	\$1763.15	\$1526.23	\$1925.63	

The following options require modification of the product number.

Stain repellent

To specify, add **P** to the end of the product number; **Example:** S74-24-1HP (add **\$55.85** list)

**NOTE:** Stain repellent is available on fabric surfaces only.

# Maari

## Four-Star Base Chair

### Without Arms



S74-44-0H



S74-24-0H



S74-22-0H

### Dimensions

- \*SH: 18"(457mm)
- H: 34"(864mm)
- D: 25.5"(648mm)
- W: 21.5"(546mm)
- \*SW: 18.5"(470mm)
- \*SD: 16.75"(425mm)

\* All measurements taken with the BIFMA chair measuring device.

### Features

- Seat: High-strength polymer shell with optional upholstered seat pad.
- Back: High-strength polymer shell with optional upholstered back pad.
- Base: Fixed height four-star base with glides.
- Glides: Plastic or felt.
- Seat swivels 360°.
- COM yardage / COL square footage:  
Seat: 0.75/6.75  
Back: 0.75/6.75

### To Order, Specify:

1) Product number, including:

#### 1 Seat Surface:

- 1 Leather
- 2 Fabric
- 3 Faux Leather
- 4 Polymer

#### 2 Back Surface:

- 1 Leather
- 2 Fabric
- 3 Faux Leather
- 4 Polymer

#### 3 Glide Option:

- H Plastic Glides
- K Felt Glides

- 2) Shell color (required for upholstered and non-upholstered).
- 3) Seat upholstery and color (if applicable).
- 4) Back upholstery and color (if applicable).
- 5) Base trim color.  
Add **\$82.27** list for Smooth Plaster & Matte finish.

Number 1 2 3	Price	Fabric Grade		C	D	E	F	G	H	Leather Grade A	Leather Grade B	
		A	B									
<b>Without Optional Upholstered Pad</b>												
S74- 4 4 -0	\$786.80	N/A	N/A	N/A	N/A	N/A	N/A	N/A	N/A	N/A	N/A	
<b>With Upholstered Seat Pad</b>												
S74- 4 4 -0	N/A	\$ 952.03	\$ 975.44	\$ 986.46	\$1011.26	\$1027.79	\$1103.53	\$1151.72	\$1230.22	\$1111.76	\$1311.46	
<b>With Upholstered Seat and Back Pad</b>												
S74- 4 4 -0	N/A	\$1117.26	\$1164.08	\$1186.12	\$1235.72	\$1268.78	\$1420.26	\$1516.64	\$1673.64	\$1436.72	\$1836.12	

The following options require modification of the product number.

Stain repellent

To specify, add **P** to the end of the product number; **Example:** S74-24-0HP (add **\$55.85** list)

**NOTE:** Stain repellent is available on fabric surfaces only.

# Maari

## Five-Star Base Chair

### With Arms



S75-44-11



S75-24-11



S75-22-11

### Dimensions

- \*SH: 16"-21"  
(406mm-533mm)
- H: 32"(813mm)
- D: 28.5"(724mm)
- W: 28.5"(724mm)
- \*SW: 18.5"(470mm)
- \*SD: 16.75"(425mm)
- \*AH: 8.5"(216mm)
- Between Arms: 22"(559mm)

\* All measurements taken with the BIFMA chair measuring device.

### Features

- Seat: High-strength polymer shell with optional upholstered seat pad.
- Back: High-strength polymer shell with optional upholstered back pad.
- Base: Five-star height adjustable base with casters.
- Height adjustment range: 16"(406mm)-21"(533mm)
- Arm caps: Polypropylene.
- Casters: Hard casters will be color matched to the base. Soft casters available in Black only.
- Tablet option:
  - Tablet arm available right or left handed.
  - Dual-pivot tablet rotates 360° at both the arm's pivot joint and tablet surface connection point.
  - Tablet surface is 11.5"(292mm)D x 19"(483mm)W and 0.75"(19mm) thick.
  - Tablet surface available in painted MDF, laminate and wood in White Oak or Walnut.
- COM yardage / COL square footage:
  - Seat: 0.75/6.75
  - Back: 0.75/6.75

### Specification Tips

- Tablet arm handedness can be changed in the field; however, tablet option cannot be added or removed in the field.
- Pivot arm/tablet will need to be field installed to the support arm.

### To Order, Specify:

1) Product number, including:

#### 1 Seat Surface:

- 1 Leather
- 2 Fabric
- 3 Faux Leather
- 4 Polymer

#### 2 Back Surface:

- 1 Leather
- 2 Fabric
- 3 Faux Leather
- 4 Polymer

#### 3 Caster Option:

- 1 Hard Casters
- 2 Soft Casters, add **\$62.83** list

#### 4 Tablet Option (if applicable):

- R Right Hand
- L Left Hand

- 2) Shell color (required for upholstered and non-upholstered).
- 3) Seat upholstery and color (if applicable).
- 4) Back upholstery and color (if applicable).
- 5) Base trim color.  
Add **\$82.27** list for Smooth Plaster & Matte finish.
- 6) Trim color for arm caps.
- 7) Tablet surface color (if applicable).
- 8) Tablet arm trim color (if applicable).  
TR-F Black  
TR-M1 Black Matte  
TR-PLS Smooth Plaster  
TR-M2 Smooth Plaster Matte

Tablet Description	Number				Price	Fabric Grade								Leather Grade A	Leather Grade B
	1	2	3	4		A	B	C	D	E	F	G	H		
<b>Polymer Shell Without Optional Upholstered Pad</b>															
No Tablet	S75-	4	4	-1	\$ 860.65	N/A	N/A	N/A	N/A	N/A	N/A	N/A	N/A	N/A	
Painted MDF	S75-	4	4	-1	1559.03	N/A	N/A	N/A	N/A	N/A	N/A	N/A	N/A	N/A	
Laminate - Grade A	S75-	4	4	-1	1694.99	N/A	N/A	N/A	N/A	N/A	N/A	N/A	N/A	N/A	
Laminate - Grade B	S75-	4	4	-1	1711.06	N/A	N/A	N/A	N/A	N/A	N/A	N/A	N/A	N/A	
Wood- White Oak	S75-	4	4	-1	2510.79	N/A	N/A	N/A	N/A	N/A	N/A	N/A	N/A	N/A	
Wood - Walnut	S75-	4	4	-1	2578.78	N/A	N/A	N/A	N/A	N/A	N/A	N/A	N/A	N/A	
<b>Polymer Shell With Upholstered Seat Pad</b>															
No Tablet	S75-	4	4	-1	N/A	\$1025.88	\$1049.29	\$1060.31	\$1085.11	\$1101.64	\$1177.38	\$1225.57	\$1304.07	\$1185.61	\$1385.31
Painted MDF	S75-	4	4	-1	N/A	1724.26	1747.67	1758.69	1783.49	1800.02	1875.76	1923.95	2002.45	1883.99	2083.69
Laminate - Grade A	S75-	4	4	-1	N/A	1860.22	1883.64	1894.65	1919.45	1935.98	2011.73	2059.91	2138.41	2019.96	2219.66
Laminate - Grade B	S75-	4	4	-1	N/A	1876.29	1899.70	1910.72	1935.52	1952.04	2027.79	2075.98	2154.47	2036.02	2235.72
Wood- White Oak	S75-	4	4	-1	N/A	2676.02	2699.43	2710.45	2735.25	2751.78	2827.52	2875.71	2954.21	2835.75	3035.45
Wood - Walnut	S75-	4	4	-1	N/A	2744.01	2767.42	2778.44	2803.24	2819.77	2895.51	2943.70	3022.20	2903.74	3103.44
<b>Polymer Shell With Upholstered Seat and Back Pads</b>															
No Tablet	S75-	4	4	-1	N/A	\$1191.11	\$1237.93	\$1259.97	\$1309.57	\$1342.63	\$1494.11	\$1590.49	\$1747.49	\$1510.57	\$1909.97
Painted MDF	S75-	4	4	-1	N/A	1889.49	1936.31	1958.35	2007.95	2041.01	2192.49	2288.87	2445.87	2208.95	2608.35
Laminate - Grade A	S75-	4	4	-1	N/A	2025.45	2072.28	2094.31	2143.91	2176.97	2328.46	2424.83	2581.82	2344.92	2744.32
Laminate - Grade B	S75-	4	4	-1	N/A	2041.52	2088.35	2110.37	2159.98	2193.03	2344.52	2440.89	2597.89	2360.99	2760.39
Wood- White Oak	S75-	4	4	-1	N/A	2841.25	2888.07	2910.11	2959.71	2992.77	3144.25	3240.63	3397.63	3160.71	3560.11
Wood - Walnut	S75-	4	4	-1	N/A	2909.24	2956.06	2978.10	3027.70	3060.76	3212.24	3308.62	3465.62	3228.70	3628.10



# Maari

## Five-Star Base Chair

### Without Arms



S75-44-01



S75-24-01



S75-22-01

### Dimensions

- \*SH: 16"-21"  
(406mm-533mm)
- H: 32"(813mm)
- D: 28.5"(724mm)
- W: 28.5"(724mm)
- \*SW: 18.5"(470mm)
- \*SD: 16.75"(425mm)

\* All measurements taken with the BIFMA chair measuring device.

### Features

- Seat: High-strength polymer shell with optional upholstered seat pad.
- Back: High-strength polymer shell with optional upholstered back pad.
- Base: Five-star height adjustable base with casters.
- Height adjustment range: 16"(406mm)-21"(533mm)
- Casters: Hard casters will be color matched to the base. Soft casters available in Black only.
- Tablet option:
  - Tablet arm available right or left handed.
  - Dual-pivot tablet rotates 360° at both the arm's pivot joint and tablet surface connection point.
  - Tablet surface is 11.5"(292mm)D x 19"(483mm)W and 0.75"(19mm) thick.
  - Tablet surface available in painted MDF, laminate and wood in White Oak or Walnut.
- COM yardage / COL square footage:
  - Seat: 0.75/6.75
  - Back: 0.75/6.75

### Specification Tips

- Tablet arm handedness can be changed in the field; however, tablet option cannot be added or removed in the field.
- Pivot arm/tablet will need to be field installed to the support arm.

### To Order, Specify:

1) Product number, including:

#### 1 Seat Surface:

- 1 Leather
- 2 Fabric
- 3 Faux Leather
- 4 Polymer

#### 2 Back Surface:

- 1 Leather
- 2 Fabric
- 3 Faux Leather
- 4 Polymer

#### 3 Caster Option:

- 1 Hard Casters
- 2 Soft Casters, add **\$62.83** list

#### 4 Tablet Option (if applicable):

- R Right Hand
- L Left Hand

- 2) Shell color (required for upholstered and non-upholstered).
- 3) Seat upholstery and color (if applicable).
- 4) Back upholstery and color (if applicable).
- 5) Base trim color. Add **\$82.27** list for Smooth Plaster & Matte finish.
- 6) Tablet surface color (if applicable).
- 7) Tablet arm trim color (if applicable).
  - TR-F Black
  - TR-M1 Black Matte
  - TR-PLS Smooth Plaster
  - TR-M2 Smooth Plaster Matte

Tablet Description	Number	1 2 3 4				Price	Fabric Grade								Leather Grade A	Leather Grade B
		A	B	C	D		E	F	G	H						
<b>Polymer Shell Without Optional Upholstered Pad</b>																
No Tablet	S75-	4	4	-0		\$ 771.14	N/A	N/A	N/A	N/A	N/A	N/A	N/A	N/A	N/A	
Painted MDF	S75-	4	4	-0	P	1469.52	N/A	N/A	N/A	N/A	N/A	N/A	N/A	N/A	N/A	
Laminate - Grade A	S75-	4	4	-0	L	1605.48	N/A	N/A	N/A	N/A	N/A	N/A	N/A	N/A	N/A	
Laminate - Grade B	S75-	4	4	-0	L	1621.55	N/A	N/A	N/A	N/A	N/A	N/A	N/A	N/A	N/A	
Wood - White Oak	S75-	4	4	-0	W	2421.28	N/A	N/A	N/A	N/A	N/A	N/A	N/A	N/A	N/A	
Wood - Walnut	S75-	4	4	-0	W	2489.27	N/A	N/A	N/A	N/A	N/A	N/A	N/A	N/A	N/A	
<b>Polymer Shell With Upholstered Seat Pad</b>																
No Tablet	S75-		4	-0		N/A	\$ 936.37	\$ 959.78	\$ 970.80	\$ 995.60	\$1012.13	\$1087.87	\$1136.06	\$1214.56	\$1096.10	\$1295.80
Painted MDF	S75-		4	-0	P	N/A	1634.75	1658.16	1669.18	1693.98	1710.51	1786.25	1834.44	1912.94	1794.48	1994.18
Laminate - Grade A	S75-		4	-0	L	N/A	1770.71	1794.12	1805.14	1829.94	1846.47	1922.21	1970.40	2048.90	1930.45	2130.15
Laminate - Grade B	S75-		4	-0	L	N/A	1786.77	1810.19	1821.20	1846.01	1862.53	1938.28	1986.46	2064.96	1946.51	2146.21
Wood - White Oak	S75-		4	-0	W	N/A	2586.51	2609.92	2620.94	2645.74	2662.27	2738.01	2786.20	2864.70	2746.24	2945.94
Wood - Walnut	S75-		4	-0	W	N/A	2654.50	2677.91	2688.93	2713.73	2730.26	2806.00	2854.19	2932.69	2814.23	3013.93
<b>Polymer Shell With Upholstered Seat and Back Pads</b>																
No Tablet	S75-			-0		N/A	\$1101.60	\$1148.42	\$1170.46	\$1220.06	\$1253.12	\$1404.60	\$1500.98	\$1657.98	\$1421.06	\$1820.46
Painted MDF	S75-			-0	P	N/A	1799.98	1846.80	1868.84	1918.44	1951.50	2102.98	2199.36	2356.36	2119.44	2518.84
Laminate - Grade A	S75-			-0	L	N/A	1935.94	1982.77	2004.80	2054.40	2087.45	2238.95	2335.32	2492.31	2255.41	2654.81
Laminate - Grade B	S75-			-0	L	N/A	1952.00	1998.83	2020.86	2070.46	2103.52	2255.01	2351.38	2508.38	2271.48	2670.87
Wood - White Oak	S75-			-0	W	N/A	2751.74	2798.56	2820.60	2870.20	2903.26	3054.74	3151.12	3308.12	3071.20	3470.60
Wood - Walnut	S75-			-0	W	N/A	2819.73	2866.55	2888.59	2938.19	2971.25	3122.73	3219.11	3376.11	3139.19	3538.59

# Maari

## Sled Base Stool

### Standard Back

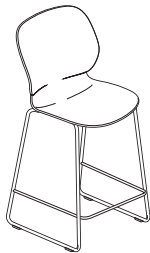

S7HB-44-0H  
S7HC-44-0H



S7HB-24-0H  
S7HC-24-0H

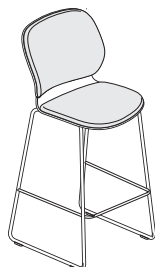

S7HB-22-0H  
S7HC-22-0H

### Dimensions

- \*SH: 30"(762mm)  
Bar Height  
26"(660mm)  
Counter Height
- H: 45.5"(1156mm)  
Bar Height  
41.5"(1054mm)  
Counter Height
- D: 23"(584mm)  
W: 23"(584mm)
- \*SW: 18.5"(470mm)
- \*SD: 16.75"(425mm)

\* All measurements taken with the BIFMA chair measuring device.

### Features

- Seat: High-strength polymer shell with optional upholstered seat pad.
- Back: High-strength polymer shell with optional upholstered back pad.
- Base: Sled base available in bar height or counter height.
- Glides: Plastic or felt.
- Available without arms only.
- COM yardage / COL square footage:  
Seat: 0.75/6.75  
Back: 0.75/6.75

### To Order, Specify:

1) Product number, including:

#### 1 Seat Surface:

- 1 Leather
- 2 Fabric
- 3 Faux Leather
- 4 Polymer

#### 2 Back Surface:

- 1 Leather
- 2 Fabric
- 3 Faux Leather
- 4 Polymer

#### 3 Glide Option:

- H Plastic Glides
- K Felt Glides

2) Shell color (required for upholstered and non-upholstered).

3) Seat upholstery and color (if applicable).

4) Back upholstery and color (if applicable).

5) Base trim color.  
Add **\$82.27** list for Smooth Plaster & Matte finish.

Description	Number	1	2	3	Price	Fabric Grade					Leather Grade A	Leather Grade B			
						A	B	C	D	E			F	G	H
<b>Without Optional Upholstered Pad</b>															
Bar Height	S7HB-	4	4	-0	\$725.61	N/A	N/A	N/A	N/A	N/A	N/A	N/A	N/A		
Counter Height	S7HC-	4	4	-0	691.27	N/A	N/A	N/A	N/A	N/A	N/A	N/A	N/A		
<b>With Upholstered Seat Pad</b>															
Bar Height	S7HB-	4	-0		N/A	\$ 890.84	\$ 914.25	\$ 925.27	\$ 950.07	\$ 966.60	\$1042.34	\$1090.53	\$1169.03	\$1050.57	\$1250.27
Counter Height	S7HC-	4	-0		N/A	856.50	879.91	890.93	915.73	932.26	1008.00	1056.19	1134.69	1016.23	1215.93
<b>With Upholstered Seat and Back Pad</b>															
Bar Height	S7HB-		-0		N/A	\$1056.07	\$1102.89	\$1124.93	\$1174.53	\$1207.59	\$1359.07	\$1455.45	\$1612.45	\$1375.53	\$1774.93
Counter Height	S7HC-		-0		N/A	1021.73	1068.55	1090.59	1140.19	1173.25	1324.73	1421.11	1578.11	1341.19	1740.59

The following options require modification of the product number.

Stain repellent

To specify, add **P** to the end of the product number; **Example:** S7HB-24-0HP (add **\$55.85** list)

**NOTE:** Stain repellent is available on fabric surfaces only.

# Maari

Sled Base Stool

**Low Back**



S8HB-24-0H  
S8HC-24-0H

**Dimensions**

- \*SH: 30"(762mm)
- Bar Height 26"(660mm)
- Counter Height H: 35.25"(895mm)
- Bar Height 31.25"(794mm)
- Counter Height D: 23"(584mm)
- W: 23"(584mm)
- \*SW: 18.5"(470mm)
- \*SD: 16.75"(425mm)

\* All measurements taken with the BIFMA chair measuring device.

**Features**

- Seat: High-strength polymer shell with or without upholstered seat pad.
- Back: High-strength low back polymer shell.
- Base: Available in bar height or counter height.
- Glides: Plastic or felt.
- Available without arms only.
- COM yardage / COL square footage: Seat: 0.75/6.75

**To Order, Specify:**

1) Product number, including:

**1 Seat Surface:**

- 1** Leather
- 2** Fabric
- 3** Faux Leather
- 4** Polymer

**2 Glide Option:**

- H** Plastic Glides
- K** Felt Glides

- 2) Shell color.
- 3) Seat upholstery and color (if applicable).
- 4) Base trim color. Add **\$82.27** list for Smooth Plaster & Matte finish.

Description	Number		Price	Fabric Grade		C	D	E	F	G	H	Leather Grade A	Leather Grade B
	1	2		A	B								
<b>Without Upholstered Seat Pad</b>													
Bar Height	S8HB-	44 -0	\$691.19	N/A	N/A	N/A	N/A	N/A	N/A	N/A	N/A	N/A	N/A
Counter Height	S8HC-	44 -0	656.85	N/A	N/A	N/A	N/A	N/A	N/A	N/A	N/A	N/A	N/A
<b>With Upholstered Seat Pad</b>													
Bar Height	S8HB-	4 -0	N/A	\$856.42	\$879.83	\$890.85	\$915.65	\$932.18	\$1007.92	\$1056.11	\$1134.61	\$1016.15	\$1215.85
Counter Height	S8HC-	4 -0	N/A	822.08	845.49	856.51	881.31	897.84	973.58	1021.77	1100.27	981.81	1181.51

The following options require modification of the product number.

Stain repellent

To specify, add **P** to the end of the product number; **Example: S8HB-24-0HP** (add **\$55.85** list)

**NOTE:** Stain repellent is available on fabric surfaces only.

# Maari

## Four-Leg Stool

### With Arms



S7SB-44-1H  
S7SC-44-1H



S7SB-24-1H  
S7SC-24-1H

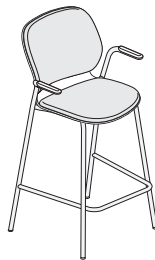

S7SB-22-1H  
S7SC-22-1H

### Dimensions

- \*SH: 30"(762mm)  
Bar Height  
26"(660mm)  
Counter Height
- H: 45.5"(1156mm)  
Bar Height  
41.5"(1054mm)  
Counter Height
- D: 23"(584mm)
- W: 23"(584mm)
- \*SW: 18.5"(470mm)
- \*SD: 16.75"(425mm)
- \*AH: 8.5"(216mm)

\* All measurements taken with the BIFMA chair measuring device.

### Features

- Seat: High-strength polymer shell with optional upholstered seat pad.
- Back: High-strength polymer shell with optional upholstered back pad.
- Arm caps: Polypropylene.
- Base: Four-Leg available in bar height or counter height.
- Glides: Plastic or felt.
- COM yardage / COL square footage:  
Seat: 0.75/6.75  
Back: 0.75/6.75

### To Order, Specify:

1) Product number, including:

#### 1 Seat Surface:

- 1 Leather
- 2 Fabric
- 3 Faux Leather
- 4 Polymer

#### 2 Back Surface:

- 1 Leather
- 2 Fabric
- 3 Faux Leather
- 4 Polymer

#### 3 Glide Option:

- H Plastic Glides
- K Felt Glides

2) Shell color (required for upholstered and non-upholstered).

3) Seat upholstery and color (if applicable).

4) Back upholstery and color (if applicable).

5) Base trim color.  
Add **\$82.27** list for Smooth Plaster & Matte finish.

6) Color for arm caps.

Description	Number	1	2	3	Price	Fabric Grade						Leather Grade A	Leather Grade B		
						A	B	C	D	E	F			G	H
<b>Without Optional Upholstered Pad</b>															
Bar Height	S7SB-	4	4	-1	\$915.65	N/A	N/A	N/A	N/A	N/A	N/A	N/A	N/A	N/A	
Counter Height	S7SC-	4	4	-1	881.31	N/A	N/A	N/A	N/A	N/A	N/A	N/A	N/A	N/A	
<b>With Upholstered Seat Pad</b>															
Bar Height	S7SB-	4	4	-1	N/A	\$1080.88	\$1104.29	\$1115.31	\$1140.11	\$1156.64	\$1232.38	\$1280.57	\$1359.07	\$1240.61	\$1440.31
Counter Height	S7SC-	4	4	-1	N/A	1046.54	1069.95	1080.97	1105.77	1122.30	1198.04	1246.23	1324.73	1206.27	1405.97
<b>With Upholstered Seat and Back Pad</b>															
Bar Height	S7SB-	4	4	-1	N/A	\$1246.11	\$1292.93	\$1314.97	\$1364.57	\$1397.63	\$1549.11	\$1645.49	\$1802.49	\$1565.57	\$1964.97
Counter Height	S7SC-	4	4	-1	N/A	1211.77	1258.59	1280.63	1330.23	1363.29	1514.77	1611.15	1768.15	1531.23	1930.63

The following options require modification of the product number.

Stain repellent

To specify, add **P** to the end of the product number; **Example:** S7SB-24-1HP (add **\$55.85** list)

**NOTE:** Stain repellent is available on fabric surfaces only.

# Maari

## Four-Leg Stool

### Without Arms

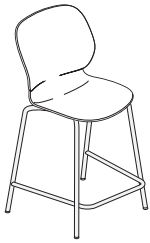

S7SB-44-0H  
S7SC-44-0H



S7SB-24-0H  
S7SC-24-0H

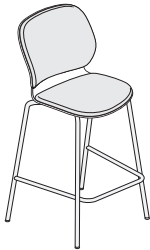

S7SB-22-0H  
S7SC-22-0H

### Dimensions

- \*SH: 30"(762mm)  
Bar Height  
26"(660mm)  
Counter Height
- H: 45.5"(1156mm)  
Bar Height  
41.5"(1054mm)  
Counter Height
- D: 23"(584mm)
- W: 23"(584mm)
- \*SW: 18.5"(470mm)
- \*SD: 16.75"(425mm)

\* All measurements taken with the BIFMA chair measuring device.

### Features

- Seat: High-strength polymer shell with optional upholstered seat pad.
- Back: High-strength polymer shell with optional upholstered back pad.
- Base: Four-Leg available in bar height or counter height.
- Glides: Plastic or felt.
- COM yardage / COL square footage:  
Seat: 0.75/6.75  
Back: 0.75/6.75

### To Order, Specify:

1) Product number, including:

#### 1 Seat Surface:

- 1 Leather
- 2 Fabric
- 3 Faux Leather
- 4 Polymer

#### 2 Back Surface:

- 1 Leather
- 2 Fabric
- 3 Faux Leather
- 4 Polymer

#### 3 Glide Option:

- H Plastic Glides
- K Felt Glides

- 2) Shell color (required for upholstered and non-upholstered).
- 3) Seat upholstery and color (if applicable).
- 4) Back upholstery and color (if applicable).
- 5) Base trim color.  
Add **\$82.27** list for Smooth Plaster & Matte finish.

Description	Number	Price	Fabric Grade								Leather Grade A	Leather Grade B	
			1	2	3	A	B	C	D	E			F
<b>Without Optional Upholstered Pad</b>													
Bar Height	S7SB- 4 4 -0	\$826.14											
Counter Height	S7SC- 4 4 -0	791.80											
<b>With Upholstered Seat Pad</b>													
Bar Height	S7SB- 4 -0	N/A	\$ 991.37	\$1014.78	\$1025.80	\$1050.60	\$1067.13	\$1142.87	\$1191.06	\$1269.56	\$1151.10	\$1350.80	
Counter Height	S7SC- 4 -0	N/A	957.03	980.44	991.46	1016.26	1032.79	1108.53	1156.72	1235.22	1116.76	1316.46	
<b>With Upholstered Seat and Back Pad</b>													
Bar Height	S7SB- -0	N/A	\$1156.60	\$1203.42	\$1225.46	\$1275.06	\$1308.12	\$1459.60	\$1555.98	\$1712.98	\$1476.06	\$1875.46	
Counter Height	S7SC- -0	N/A	1122.26	1169.08	1191.12	1240.72	1273.78	1425.26	1521.64	1678.64	1441.72	1841.12	

The following options require modification of the product number.

Stain repellent

To specify, add **P** to the end of the product number; **Example:** S7SB-24-0HP (add **\$55.85** list)

**NOTE:** Stain repellent is available on fabric surfaces only.

# Maari

## Wood-Leg Stool

### Standard Back



S7WB-44-0H  
S7WC-44-0H



S7WB-24-0H  
S7WC-24-0H



S7WB-22-0H  
S7WC-22-0H

### Dimensions

- \*SH: 30"(762mm)  
Bar Height  
26"(660mm)  
Counter Height
- H: 45.5"(1156mm)  
Bar Height  
41.5"(1054mm)  
Counter Height
- D: 23"(584mm)
- W: 23"(584mm)
- \*SW: 18.5"(470mm)
- \*SD: 16.75"(425mm)

\* All measurements taken with the BIFMA chair measuring device.

### Features

- Seat: High-strength polymer shell with optional upholstered seat pad.
- Back: High-strength polymer shell with optional upholstered back pad.
- Base: Wood leg available in bar height or counter height.
- Glides: Plastic or felt.
- Available without arms only.
- Foot ring available in black or chrome.
- COM yardage / COL square footage:  
Seat: 0.75/6.75  
Back: 0.75/6.75

### To Order, Specify:

1) Product number, including:

#### 1 Seat Surface:

- 1 Leather
- 2 Fabric
- 3 Faux Leather
- 4 Polymer

#### 2 Back Surface:

- 1 Leather
- 2 Fabric
- 3 Faux Leather
- 4 Polymer

#### 3 Glide Option:

- H Plastic Glides
- K Felt Glides

- 2) Shell color (required for upholstered and non-upholstered).
- 3) Seat upholstery and color (if applicable).
- 4) Back upholstery and color (if applicable).
- 5) Wood finish.
- 6) Foot ring finish.  
TR-F Black  
KR-V Chrome, add **\$135.54** list

Description	Number	1	2	3	Price	Fabric Grade					Leather				
						A	B	C	D	E	F	G	H	Grade A	Grade B
<b>Without Optional Upholstered Pad</b>															
Bar Height	S7WB-	4	4	-0	\$1725.55	N/A	N/A	N/A	N/A	N/A	N/A	N/A	N/A	N/A	
Counter Height	S7WC-	4	4	-0	1691.21	N/A	N/A	N/A	N/A	N/A	N/A	N/A	N/A	N/A	
<b>With Upholstered Seat Pad</b>															
Bar Height	S7WB-		4	-0	N/A	\$1890.78	\$1914.19	\$1925.21	\$1950.01	\$1966.54	\$2042.28	\$2090.47	\$2168.97	\$2050.51	\$2250.21
Counter Height	S7WC-		4	-0	N/A	1856.44	1879.85	1890.87	1915.67	1932.20	2007.94	2056.13	2134.63	2016.17	2215.87
<b>With Upholstered Seat and Back Pad</b>															
Bar Height	S7WB-			-0	N/A	\$2056.01	\$2102.83	\$2124.87	\$2174.47	\$2207.53	\$2359.01	\$2455.39	\$2612.39	\$2375.47	\$2774.87
Counter Height	S7WC-			-0	N/A	2021.67	2068.49	2090.53	2140.13	2173.19	2324.67	2421.05	2578.05	2341.13	2740.53

The following options require modification of the product number.

Stain repellent

To specify, add **P** to the end of the product number; **Example:** S7WB-24-0HP (add **\$55.85** list)

**NOTE:** Stain repellent is available on fabric surfaces only.

# Maari

Wood-Leg Stool

**Low Back**



S8WB-24-0H  
S8WC-24-0H

**Dimensions**

- \*SH: 30"(762mm)
- Bar Height 26"(660mm)
- Counter Height H: 35.25"(895mm)
- Bar Height 31.25"(794mm)
- Counter Height D: 23"(584mm)
- W: 23"(584mm)
- \*SW: 18.5"(470mm)
- \*SD: 16.75"(425mm)

\* All measurements taken with the BIFMA chair measuring device.

**Features**

- Seat: High-strength polymer shell with upholstered seat pad.
- Back: High-strength low back polymer shell.
- Base: Available in bar height or counter height.
- Foot ring available in black or chrome.
- Glides: Plastic or felt.
- Available without arms only.
- COM yardage / COL square footage: Seat: 0.75/6.75

**To Order, Specify:**

1) Product number, including:

**1 Seat Surface:**

- 1** Leather
- 2** Fabric
- 3** Faux Leather

**2 Glide Option:**

- H** Plastic Glides
- K** Felt Glides

- 2) Shell color.
- 3) Seat upholstery and color
- 4) Wood finish.
- 5) Foot ring finish.  
TR-F Black  
KR-V Chrome, add **\$135.54** list

Description	Number		Fabric Grade		C	D	E	F	G	H	Leather Grade A	Leather Grade B
	1	2	A	B								
<b>With Upholstered Seat Pad</b>												
Bar Height	S8WB-	4 -0	\$1890.78	\$1914.19	\$1925.21	\$1950.01	\$1966.54	\$2042.28	\$2090.47	\$2168.97	\$2050.51	\$2250.21
Counter Height	S8WC-	4 -0	1856.44	1879.85	1890.87	1915.67	1932.20	2007.94	2056.13	2134.63	2016.17	2215.87

The following options require modification of the product number.

Stain repellent

To specify, add **P** to the end of the product number; **Example:** S8WB-24-0HP (add **\$55.85** list)

**NOTE:** Stain repellent is available on fabric surfaces only.

This page intentionally blank



# Wood Seating

## General Specifications

### Features and Options

Guest and occasional models feature frames constructed solid hardwood, laminated plywood, laminated hardwood core and premium veneers, or rigid polyurethane.

Office seating models feature an inner frame construction of tubular steel or solid hardwood or laminated plywood or molded plywood. Swivel bases are standard with hard dual-wheel casters.

Exposed wood surfaces are finished with two top coats of pre-catalyst nitrocellulose lacquer for a durable finish.

Refer to the appropriate seating model for applicable features and options.

### COM & COL General Information

To order a COM fabric (Customer's Own Material), contact the Haworth Inquiry Center (1.800.426.8562), your local Haworth dealer, or go to [haworth.com/surfaces](http://haworth.com/surfaces) > COM Library to find out if the COM you have selected has already been tested and approved. The surface collection site also has information on the Haworth + alliance program with Carnegie, Luna Textiles, and Maharam as well as our industry-leading Pre-Approved COM program.

COM fabrics are placed into Grades based on the cost per linear yard. If a fabric's cost exceeds the range of our highest Grade it will be noted as Non-Graded. The product will be priced at Grade A; the COM fabric costs will appear as a separate line item. The fabric charge will be Haworth's purchase cost plus a 4% administrative fee (based on the cost of the fabric). Yardage calculations will include any applicable fabric repeat.

COM Leather products will be priced at a leather Grade A; COL costs will appear as a separate line item. The leather costs will be Haworth's purchase cost plus a 4% administrative fee (based on the cost of the leather).

### General Guidelines for Product Specification

Seating specification numbers are based on a numeric logic that identifies a product by model and certain characteristics.

For instance, a product number that reads **SAS-22-A1A** identifies the product as a Candor Modern Seating with fully upholstered seat and back.

The numeric logic for this model with finish codes is shown below:

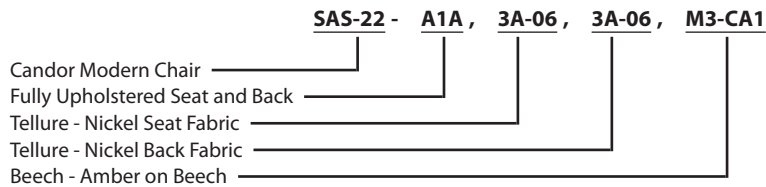

A ninth-digit suffix of the product code will indicate functional options, such as **-F** for CAL 133 option. There are exceptions to this logic; therefore, always refer to the price charts for product numbers rather than attempting to construct them. Product number modification instructions for additional options appear in footnoted copy for each applicable model.

Beyond the printed product number, fabric and finish codes are required to complete an order specification.

To communicate your order clearly, list the product number and finish codes in the sequence outlined on each price page.

### Finishes and Fabrics

A complete listing of finishes/fabrics can be found in the back of the price list.

# Candor Modern Seating

Guest/Occasional Seating

Number ① ②	Fabric Grade		C	D	E	F	G	H	Leather Grade A	Leather Grade B
	A	B								
SAS- ■ ■ -A1A	\$1524.68	\$1565.60	\$1582.02	\$1622.90	\$1647.42	\$1929.90	\$2011.76	\$2257.30	\$2073.18	\$2561.64

**Fully Upholstered Seat and Back**



SAS-22-A1A

**Dimensions**

SH: 17.8"(452mm)  
 H: 32.75"(832mm)  
 D: 23.50"(597mm)  
 W: 21"(533mm)  
 SD: 17"(432mm)  
 SW: 17.8"(452mm)  
 AH: 25"(635mm)

**Features**

- Open arms.
- Upholstered seat and back.
- Steamed beech hardwood frame. Seat frame rails are mortise and tenoned, cross locked with dowels, reinforced with corner blocks.
- Seat is HR foam over a webbed panel.
- The upholstered back frame insert is padded with foam.
- COM yardage: 1.5
- COL square footage: 27.0

**To Order, Specify:**

1) Product number, including:

**① Seat Option:**

- 1 Leather
- 2 Fabric
- 3 Faux Leather

**② Back Option:**

- 1 Leather
- 2 Fabric
- 3 Faux Leather

- 2) Fabric surface and color (seat).
- 3) Fabric surface and color (back).
- 4) Arm/frame finish color.

SAS- ■ ■ -A3A	\$1524.68	\$1565.60	\$1582.02	\$1622.90	\$1647.42	\$1929.90	\$2011.76	\$2257.30	\$2073.18	\$2561.64
---------------	-----------	-----------	-----------	-----------	-----------	-----------	-----------	-----------	-----------	-----------

**Fully Upholstered Seat and 1/2 Back**



SAS-22-A3A

**Dimensions**

SH: 17.8"(452mm)  
 H: 32.50"(826mm)  
 D: 23"(584mm)  
 W: 21"(533mm)  
 SD: 17"(432mm)  
 SW: 17.8"(452mm)  
 AH: 25"(635mm)

**Features**

- Open arms.
- Upholstered seat and back.
- Steamed beech hardwood frame. Seat frame rails are mortise and tenoned, cross locked with dowels, reinforced with corner blocks.
- Seat is HR foam over a webbed panel.
- The upholstered back frame insert is padded with foam.
- COM yardage: 1.25
- COL square footage: 22.5

**To Order, Specify:**

1) Product number, including:

**① Seat Option:**

- 1 Leather
- 2 Fabric
- 3 Faux Leather

**② Back Option:**

- 1 Leather
- 2 Fabric
- 3 Faux Leather

- 2) Fabric surface and color (seat).
- 3) Fabric surface and color (back).
- 4) Arm/frame finish color.

The following options require modification of the product number.

Stain Repellent

Moisture Barrier with Stain Repellent

To specify, add **-P** to the end of the product number; **Example:** SAS-22-A1A-**P** (add **\$63.44** list)

To specify, add **-D** to the end of the product number; **Example:** SAS-22-A1A-**D** (add **\$83.90** list)

**NOTE:** For available fabrics, refer to [surfaces.haworth.com](http://surfaces.haworth.com).

## Composites Seating Series

Guest/Occasional Seating

Base/ Frame	Number	Fabric Grade		C	D	E	F	G	H	Leather Grade A	Leather Grade B
		A	B								
Maple	4045-00	\$1948.24	\$2015.78	\$2077.15	\$2179.49	\$2240.88	\$2279.77	\$2351.38	\$2549.89	\$3276.43	\$3595.19

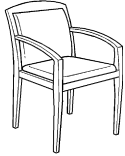
**Arc Arm,  
Upholstered Back**

4045-00

**Dimensions**

SH: 18.5"(470mm)  
H: 33.75"(857mm)  
D: 23"(584mm)  
W: 22.375"(568mm)  
SD: 18"(457mm)  
SW: 19.5"(495mm)  
AH: 24" - 26"  
(610mm-660mm)

**Features**

- Open arms.
- Upholstered seat and back.
- Maple hardwood frame. Seat frame rails are mortise and tenoned, cross locked with dowels, reinforced with corner blocks.
- Seat is HR foam over a webbed panel.
- The upholstered back frame insert is webbed and padded with foam.
- Available with fire-retardant construction to comply with California Bulletin #133.
- COM yardage: 1.25
- COL square footage: 22.5

**To Order, Specify:**

- 1) Product number.
- 2) Fabric surface and color.
- 3) Arm/frame finish color.

Maple	4049-00	\$1948.24	\$2015.78	\$2077.15	\$2179.49	\$2240.88	\$2279.77	\$2351.38	\$2549.89	\$3276.43	\$3595.19
-------	---------	-----------	-----------	-----------	-----------	-----------	-----------	-----------	-----------	-----------	-----------

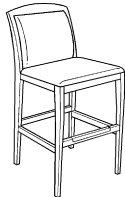
**Stool, Armless,  
Upholstered Back**

4049-00

**Dimensions**

SH: 28"(711mm)  
H: 41.125"(1045mm)  
D: 19.875"(505mm)  
W: 18.5"(470mm)  
SW: 18.5"(470mm)  
SD: 15.25"(387mm)

**Features**

- Upholstered seat and back.
- Maple hardwood frame. Seat frame rails are mortise and tenoned, cross locked with dowels, reinforced with corner blocks.
- Seat is HR foam over a webbed panel.
- The upholstered back frame insert is webbed and padded with foam.
- Standard with brass kick plate. No finish specification required.
- Available with fire-retardant construction to comply with California Bulletin #133.
- COM yardage: 1.00
- COL square footage: 18.0

**To Order, Specify:**

- 1) Product number.
- 2) Fabric surface and color.
- 3) Frame finish color.

The following options require modification of the product number.

Stain Repellent

Moisture Barrier with Stain Repellent

To specify, add **-P** to the end of the product number; **Example:** 4049-00-**P** (add **\$63.44** list)To specify, add **-D** to the end of the product number; **Example:** 4049-00-**D** (add **\$83.90** list)**NOTE:** Stain repellent and moisture barrier are not available on leather or faux leather.For available fabrics, refer to [surfaces.haworth.com](https://surfaces.haworth.com).

This page intentionally blank

# Riverbend and Pebble

<b>Environmental Factors</b>	BIFMA Level 2 Certified Greenguard / Greenguard Gold Certified.
<b>Fabrics and Finishes</b>	A complete listing of fabrics and finishes for Riverbend and Pebble is available in the back of the price list. Fabric is applied Railroaded to both Riverbend and Pebble products. Linear or patterned fabric is not recommended due to the manner in which fabric is applied. Material will not be pattern matched.  Riverbend sofas and Pebble ottomans feature large, flat surfaces, and textile crispness will be influenced by the amount of stretch in each textile. Some textiles will stretch more than others, resulting in a small amount of pooling. This can be addressed by running a hand across the surface to smooth the material.
<b>Stain Repellent</b>	To specify add "P" to end of the product number. Example: SMSN-2028-HNFP

**General Guidelines for Product Specification**

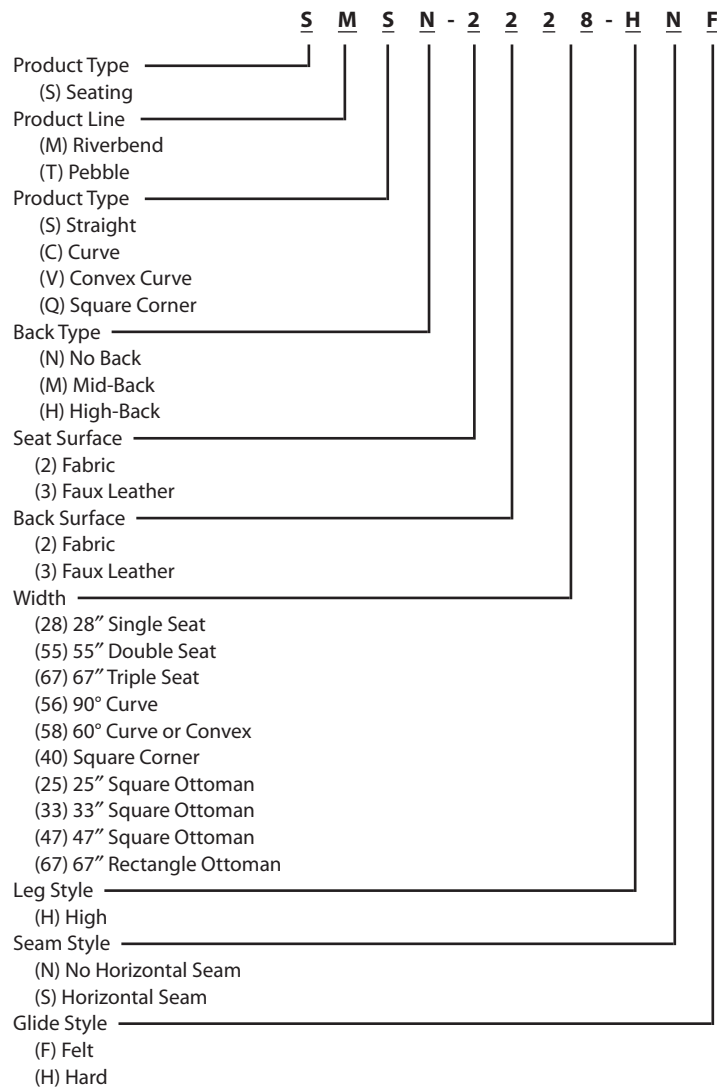

# Riverbend and Pebble

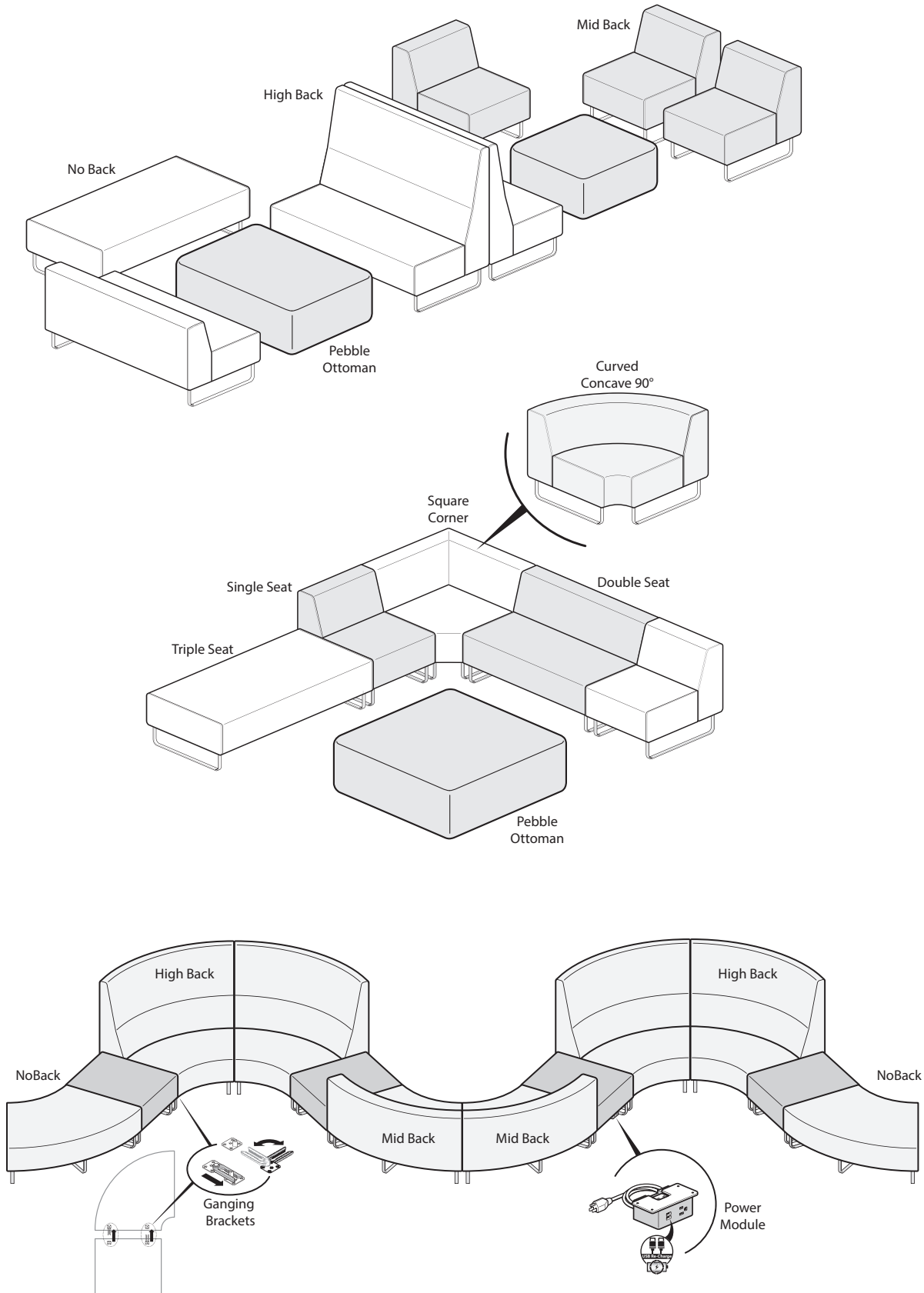

# Riverbend and Pebble

## Seam Options

### No Horizontal Seam

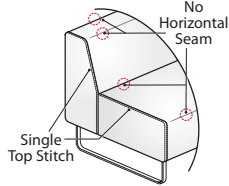

### Horizontal Seam

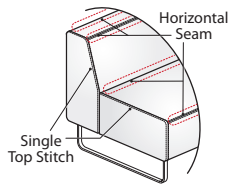

Riverbend units are available with and without a double-needle stitch horizontal seam.

When specified without horizontal seams, textiles will gently flow over the front and back edges of the seat and back, providing a simple and seamless aesthetic.

For a tailored aesthetic, Riverbend units can be specified with a horizontal seam along the front and back edges of the seat and back.

## Ganging Bracket

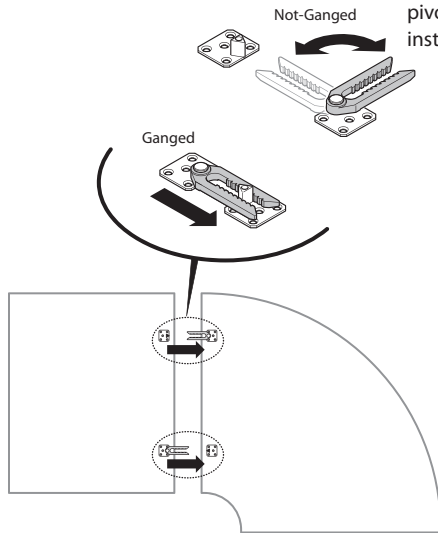

Ganging brackets are used to gang one Riverbend component to another. When not in use the ganging bracket pivots to hide under the seat. Each Ganging Bracket Kit includes two brackets, screws, a template and assembly instructions. One kit will gang two sofas together.

## Power Module

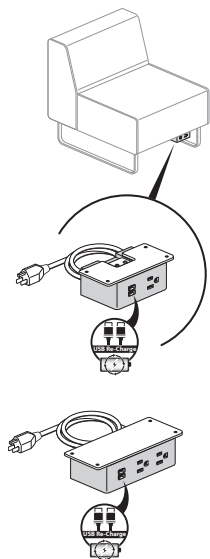

The separately specified power module provides under seat power consisting of either one or two simplex outlets (NEMA-5-15R) and one dual USB port. The Power Module must be installed along the front edge of the Riverbend seat. Power Modules may not be daisy chained together.

The Power Module is available either corded or hardwire with a 6' or 12' cord.

Included with the module are two cord management clips and attachment hardware.

Application may require approval from local authority having jurisdiction (AHJ); ensure compliance before placing orders and installing.

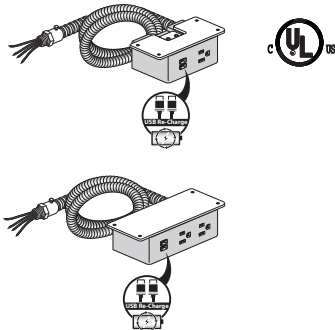

# Riverbend and Pebble

## General Specification

### Single Seat

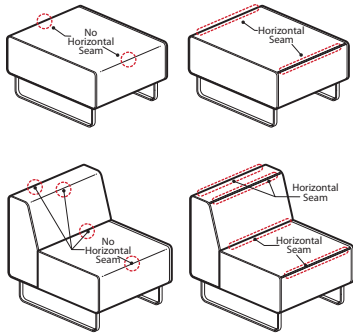

#### Features:

- Back Option: No Back, Mid-Back
- Available with horizontal seams or without horizontal seams. Horizontal seam location noted by red lines.
- Seat width 27.6"(701mm)
- Available with hard plastic or felt glides.
- Accepts separately specified power module for under seat power access.
- Use separately specified ganging bracket to connect components together.

### Double Seat

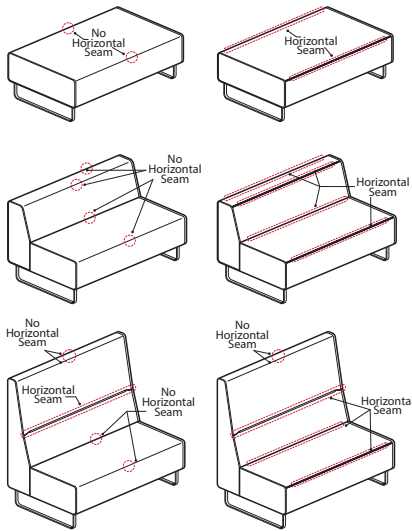

#### Features:

- Back Option: No Back, Mid-Back, High-Back
- Available with horizontal seams or without horizontal seams. Horizontal seam location noted by red lines.
- Seat width 55"(1397mm)
- Available with hard plastic or felt glides.
- Accepts separately specified power module for under seat power access.
- Use separately specified ganging bracket to connect components together.

### Triple Seat

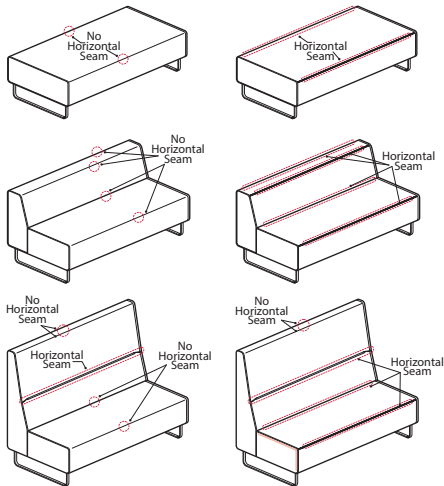

#### Features:

- Back Option: No Back, Mid-Back, High-Back
- Available with horizontal seams or without horizontal seams. Horizontal seam location noted by red lines.
- Seat width 67"(1702mm)
- Available with hard plastic or felt glides.
- Accepts separately specified power module for under seat power access.
- Use separately specified ganging bracket to connect components together.



**Riverbend and Pebble**

## General Specification

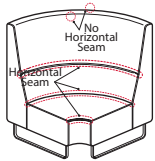
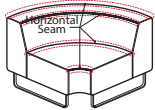
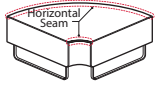
**90° Curved – Concave****Features:**

- Back Option: No Back, Mid-Back, High-Back
- Available with horizontal seams only.  
Horizontal seam placement noted in red.
- Available with hard plastic or felt glides.
- Accepts separately specified power module for under seat power access.
- Use separately specified ganging bracket to connect components together.

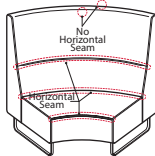
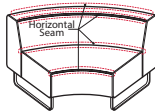
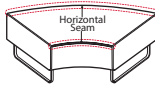
**60° Curved – Concave****Features:**

- Back Option: No Back, Mid-Back, High-Back
- Available with horizontal seams only.  
Horizontal seam placement noted in red.
- Available with hard plastic or felt glides.
- Accepts separately specified power module for under seat power access.
- Use separately specified ganging bracket to connect components together.

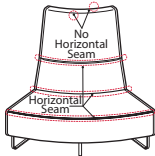
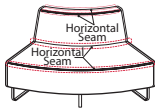
**60° Curved – Convex****Features:**

- Back Option: Mid-Back, High-Back
  - For No Back option use 60° Curved – Concave.
- Available with horizontal seams only.  
Horizontal seam placement noted in red.
- Available with hard plastic or felt glides.
- Accepts separately specified power module for under seat power access.
- Use separately specified ganging bracket to connect components together.

# Riverbend and Pebble

## General Specification

### Square Corner

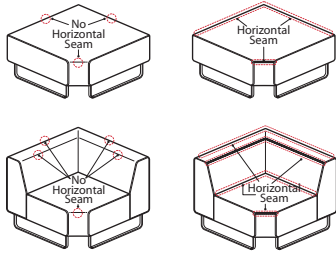

### Features:

- Back Option: No Back, Mid-Back
- Available with horizontal seams or without horizontal seams. Horizontal seam location noted in red.
- Available with hard plastic or felt glides.
- Accepts separately specified power module for under seat power access.
- Use separately specified ganging bracket to connect components together.

### Pebble Ottoman

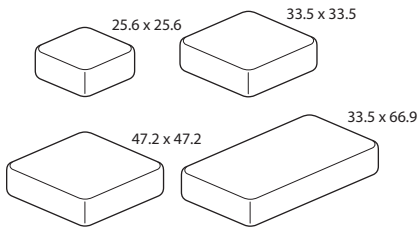

### Features:

- Available in two shapes and four sizes.
  - Square - Small - 25.6"(650mm)
  - Square - Medium - 33.5"(851mm)
  - Square - Large - 47.2"(1199mm)
  - Rectangle - 66.9"(1699mm) W X 33.5"(851mm) D
- Available with hard plastic or felt glides.

# Riverbend

Straight\*

Single Seat

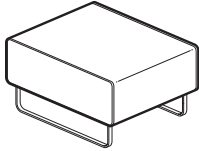

SMSN-2028-H

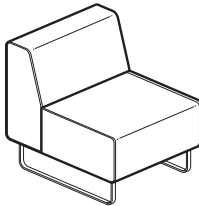

SMSM-2228-H

**Dimensions**

- SH: 17.8"(452mm)
- TH: 17.8"(452mm) - No Back  
30.7"(780mm) - Mid-Back
- SD: 33.8"(858mm) - No Back  
22.6"(574mm) - Mid-Back
- TD: 33.8"(858mm)
- TW: 27.6"(701mm)

**Features**

- Includes upholstered seat and back (if applicable) and painted steel legs.
- Seat and back available in same surface and color or different surface and color.
- Available with hard plastic glides or felt glides.
- Available with or without horizontal seams. When ordering with horizontal seams there will be a seam across the front of the seat and across the top of the mid-back.
- COM yardage:  
No Back: 2.4  
Mid-Back: 4.25 (seat 2.1/back 2.1)

**Specification Tips**

- Fabric applied railroaded.
- Linear or patterned fabric not recommended due to the manner in which fabric is applied.
- Ganging bracket available (ordered separately) to attach adjacent Riverbend products.
- Separately specified power module available for under seat power access.
- When using with adjacent curved corner unit, specify with seam option to maintain a consistent seam line across the front of the entire configuration.
- For accent pillows, refer to Openest Price List.

**To Order, Specify:**

1) Product number, including:

**1 Seat Surface:**

- 2** Fabric
- 3** Faux Leather

**2 Back Surface:**

- 2** Fabric
- 3** Faux Leather

**3 Glide Style:**

- H** Hard
- F** Felt

- 2) Seat fabric surface and color.
- 3) Back fabric surface and color.
- 4) Trim color.

**Note:** For mixed grade surface materials, please refer to the electronic design and specification tools for pricing.

Description	Number			Fabric Grade							
	1	2	3	A	B	C	D	E	F	G	H
<b>Without Horizontal Seams</b>											
No Back	SMSN-	028-HN		\$1518.00	\$1649.62	\$1693.33	\$1752.83	\$1834.77	\$2222.81	\$2545.76	\$2915.69
Mid-Back	SMSM-	28-HN		2261.53	2489.09	2556.01	2661.27	2795.37	3448.69	3745.31	4279.37
<b>With Horizontal Seams</b>											
No Back	SMSN-	028-HS		\$1609.06	\$1740.68	\$1784.39	\$1843.89	\$1925.83	\$2313.87	\$2636.82	\$3006.75
Mid-Back	SMSM-	28-HS		2352.59	2580.15	2647.07	2752.33	2886.43	3539.75	3836.37	4370.43

The following options require modification of the product number.

Stain Repellent

To specify, add **P** to end of the product number; **Example:** SMSN-2028-HNFP  
(No Back - add **\$87.98** list, Mid-Back - add **\$151.39** list)

\*This product may be subject to supplemental freight charges.

# Riverbend

Straight\*

## Double Seat

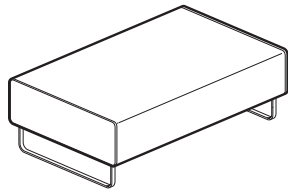

SMSN-2055-H

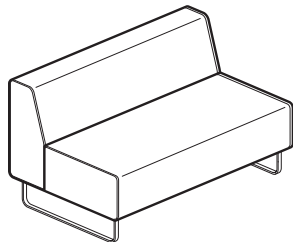

SMSM-2255-H

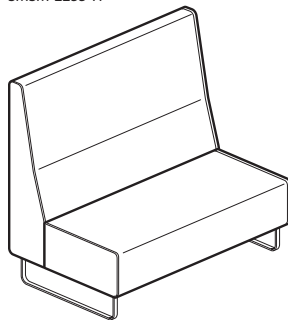

SMSH-2255-H

### Dimensions

SH: 17.8"(452mm)  
 TH: 17.8"(452mm) -  
 No Back  
 30.7"(780mm) -  
 Mid-Back  
 49.6"(1260mm) -  
 High-Back  
 SD: 33.8"(858mm) -  
 No Back  
 22.6(574mm) -  
 Mid-Back  
 22.6"(574mm) -  
 High-Back  
 TD: 33.8"(858mm)  
 TW: 55"(1397mm)

### Features

- Includes upholstered seat and back (if applicable) and painted steel legs.
- Seat and back available in same surface and color or different surface and color.
- Available with hard plastic glides or felt glides.
- Available with or without horizontal seams. When ordering with horizontal seams there will be a seam across the front of the seat and across the top of the mid-back.
- COM yardage:  
 No Back: 4.2  
 Mid-Back: 7.2 (seat 4.2/back 3.0)  
 High-Back: 9.4 (seat 4.2/back 5.2)

### Specification Tips

- Fabric applied railroaded.
- Linear or patterned fabric not recommended due to the manner in which fabric is applied.
- Ganging bracket available (ordered separately) to attach adjacent Riverbend products.
- Separately specified power module available for under seat power access.
- When using with adjacent curved corner unit, specify with seam option to maintain a consistent seam line across the front of the entire configuration.
- For accent pillows, refer to Openest Price List.

### To Order, Specify:

1) Product number, including:

#### 1 Seat Surface:

- 2 Fabric
- 3 Faux Leather

#### 2 Back Surface:

- 2 Fabric
- 3 Faux Leather

#### 3 Glide Style:

- H Hard
- F Felt

- 2) Seat fabric surface and color.
- 3) Back fabric surface and color.
- 4) Trim color.

**Note:** For mixed grade surface materials, please refer to the electronic design and specification tools for pricing.

Description	Number			Fabric Grade							
	1	2	3	A	B	C	D	E	F	G	H
<b>Without Horizontal Seams</b>											
No Back	SMSN-	055-HN		\$2503.13	\$2690.03	\$2751.71	\$2837.95	\$2953.33	\$3504.62	\$3755.01	\$4205.60
Mid-Back	SMSM-	55-HN		\$3246.66	\$3566.00	\$3671.36	\$3816.30	\$4019.14	\$4952.98	\$5379.46	\$6147.12
High-Back	SMSH-	55-HN		\$4137.30	\$4560.19	\$4700.28	\$4891.73	\$5157.19	\$6400.03	\$6965.58	\$7983.62
<b>With Horizontal Seams</b>											
No Back	SMSN-	055-HS		\$2594.19	\$2781.09	\$2842.77	\$2929.01	\$3044.39	\$3595.68	\$3846.07	\$4296.66
Mid-Back	SMSM-	55-HS		\$3337.72	\$3657.06	\$3762.42	\$3907.36	\$4110.20	\$5044.04	\$5470.52	\$6238.18
High-Back	SMSH-	55-HS		\$4228.36	\$4651.25	\$4791.34	\$4982.79	\$5248.25	\$6491.09	\$7056.64	\$8074.68

The following options require modification of the product number.

Stain Repellent

To specify, add **P** to end of the product number; **Example:** SMSN-2055-HNFP  
 (No Back - add **\$124.70** list, Mid-Back - add **\$213.75** list, High-Back - add **\$285.00** list)

\*This product may be subject to supplemental freight charges.

# Riverbend

Straight\*

### Triple Seat

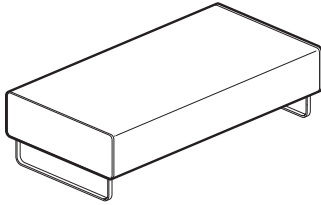

SMSN-2067-H

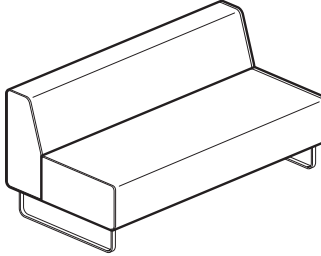

SMSM-2267-H

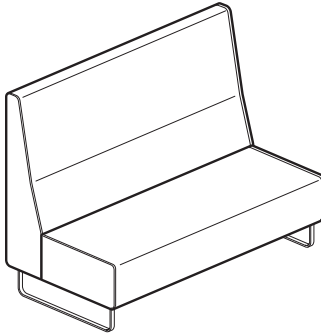

SMSH-2267-H

### Dimensions

SH: 17.8"(452mm)  
 TH: 17.8"(452mm) - No Back  
 30.7"(780mm) - Mid-Back  
 49.6"(1260mm) - High-Back  
 SD: 33.8"(858mm) - No Back  
 22.6"(574mm) - Mid-Back  
 22.6"(574mm) - High-Back  
 TD: 33.8"(858mm)  
 TW: 67"(1702mm)

### Features

- Includes upholstered seat and back (if applicable) and painted steel legs.
- Seat and back available in same surface and color or different surface and color.
- Available with hard plastic glides or felt glides.
- Available with or without horizontal seams. When ordering with horizontal seams there will be a seam across the front of the seat and across the top of the mid-back.
- COM yardage:  
 No Back: 5.0  
 Mid-Back: 8.5 (seat 5.0/back 3.5)  
 High-Back: 11.4 (seat 5.0/back 6.4)

### Specification Tips

- Fabric applied railroaded.
- Linear or patterned fabric not recommended due to the manner in which fabric is applied.
- Ganging bracket available (ordered separately) to attach adjacent Riverbend products.
- Separately specified power module available for under seat power access.
- When using with adjacent curved corner unit, specify with seam option to maintain a consistent seam line across the front of the entire configuration.
- For accent pillows, refer to Openest Price List.

### To Order, Specify:

1) Product number, including:

#### 1 Seat Surface:

- 2 Fabric
- 3 Faux Leather

#### 2 Back Surface:

- 2 Fabric
- 3 Faux Leather

#### 3 Glide Style:

- H Hard
- F Felt

- 2) Seat fabric surface and color.
- 3) Back fabric surface and color.
- 4) Trim color.

**Note:** For mixed grade surface materials, please refer to the electronic design and specification tools for pricing.

Description	Number			Fabric Grade							
	1	2	3	A	B	C	D	E	F	G	H
<b>Without Horizontal Seams</b>											
No Back	SMSN-	067-HN		\$3031.35	\$3246.30	\$3316.97	\$3415.35	\$3548.16	\$4181.24	\$4468.70	\$4986.05
Mid-Back	SMSM-	67-HN		\$3774.88	\$4148.68	\$4272.04	\$4444.52	\$4681.74	\$5777.86	\$6278.64	\$7463.56
High-Back	SMSH-	67-HN		\$4665.52	\$5170.92	\$5337.97	\$5570.82	\$5885.94	\$7373.32	\$8050.23	\$9751.82
<b>With Horizontal Seams</b>											
No Back	SMSN-	067-HS		\$3122.41	\$3337.36	\$3408.03	\$3506.41	\$3639.22	\$4272.30	\$4559.76	\$5077.11
Mid-Back	SMSM-	67-HS		\$3865.94	\$4239.74	\$4363.10	\$4535.58	\$4772.80	\$5868.92	\$6369.70	\$7554.62
High-Back	SMSH-	67-HS		\$4756.58	\$5261.98	\$5429.03	\$5661.88	\$5977.00	\$7464.38	\$8141.29	\$9842.88

The following options require modification of the product number.

Stain Repellent

To specify, add **P** to end of the product number; **Example:** SMSN-2067-HNFP  
 (No Back - add **\$142.51** list, Mid-Back - add **\$249.38** list, High-Back - add **\$338.46** list)

\*This product may be subject to supplemental freight charges.

# Riverbend

Curved — Concave\*

90°

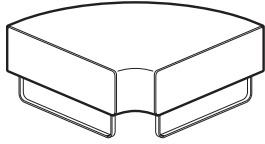

SMCN-2056-HS

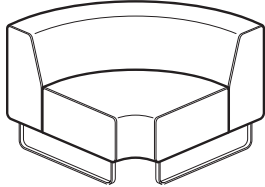

SMCM-2256-HS

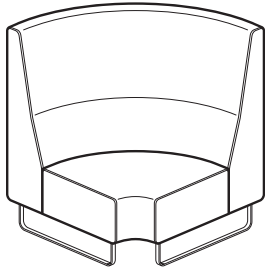

SMCH-2256-HS

### Dimensions

SH: 17.8"(452mm)  
 TH: 17.8"(452mm) -  
 No Back  
 30.7"(780mm) -  
 Mid-Back  
 49.6"(1260mm) -  
 High-Back  
 SD: 33.8"(858mm) -  
 No Back  
 22.6"(574mm) -  
 Mid-Back  
 22.6"(574mm) -  
 High-Back  
 TD: 33.8"(858mm)  
 TW: 56.3"(1430mm)

### Features

- Includes upholstered seat and back (if applicable) and painted steel legs.
- Seat and back available in same surface and color or different surface and color.
- Available with hard plastic glides or felt glides.
- Available with horizontal seam on seat front and back and across the top of the mid-back.
- COM yardage:  
 No Back: 3.2  
 Mid-Back: 6.1 (seat 2.75/back 3.35)  
 High-Back: 7.25 (seat 2.75/back 4.5)

### Specification Tips

- Fabric applied railroaded.
- Linear or patterned fabric not recommended due to the manner in which fabric is applied.
- Ganging bracket available (ordered separately) to attach adjacent Riverbend products.
- Separately specified power module available for under seat power access.
- For accent pillows, refer to Openest Price List.

### To Order, Specify:

1) Product number, including:

#### 1 Seat Surface:

- 2 Fabric
- 3 Faux Leather

#### 2 Back Surface:

- 2 Fabric
- 3 Faux Leather

#### 3 Glide Style:

- H Hard
- F Felt

- 2) Seat fabric surface and color.
- 3) Back fabric surface and color.
- 4) Trim color.

**Note:** For mixed grade surface materials, please refer to the electronic design and specification tools for pricing.

Description	Number			Fabric Grade							
	1	2	3	A	B	C	D	E	F	G	H
No Back	SMCN-	056-HS		\$2714.71	\$2881.07	\$2936.11	\$3011.41	\$3114.87	\$3604.96	\$3827.45	\$4227.98
Mid-Back	SMCM-	56-HS		\$3481.44	\$3841.52	\$3960.48	\$4125.67	\$4348.37	\$5410.31	\$6294.25	\$7306.75
High-Back	SMCH-	56-HS		\$4674.17	\$5111.10	\$5254.43	\$5454.02	\$5724.65	\$7011.07	\$7595.17	\$8646.57

The following options require modification of the product number.

Stain Repellent

To specify, add **P** to end of the product number; **Example:** SMCN-2056-HSFP  
 (No Back - add \$114.00 list, Mid-Back - add \$240.48 list, High-Back - add \$293.93 list)

\*This product may be subject to supplemental freight charges.

# Riverbend

Curved — Concave\*

60°

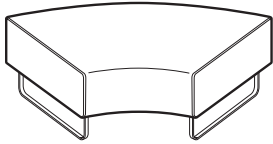

SMCN-2058-HS

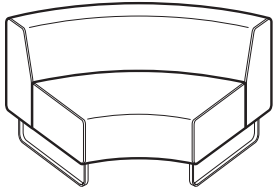

SMCM-2258-HS

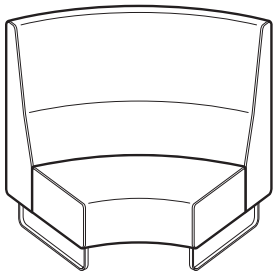

SMCH-2258-HS

### Dimensions

SH: 17.8"(452mm)  
 TH: 17.8"(452mm) -  
 No Back  
 30.7"(780mm) -  
 Mid-Back  
 49.6"(1260mm) -  
 High-Back  
 SD: 33.8"(858mm) -  
 No Back  
 22.6"(574mm) -  
 Mid-Back  
 22.6"(574mm) -  
 High-Back  
 TD: 33.8"(858mm)  
 TW: 58.3"(1481mm)

### Features

- Includes upholstered seat and back (if applicable) and painted steel legs.
- Seat and back available in same surface and color or different surface and color.
- Available with hard plastic glides or felt glides.
- Available with horizontal seam on seat front and back and across the top of the mid-back.
- COM yardage:  
 No Back: 3.5  
 Mid-Back: 7.0 (seat 3.0/back 4.0)  
 High-Back: 8.1 (seat 3.0/back 5.1)

### Specification Tips

- Fabric applied railroaded.
- Linear or patterned fabric not recommended due to the manner in which fabric is applied.
- Ganging bracket available (ordered separately) to attach adjacent Riverbend products.
- Separately specified power module available for under seat power access.
- For accent pillows, refer to Openest Price List.

### To Order, Specify:

1) Product number, including:

#### 1 Seat Surface:

- 2 Fabric
- 3 Faux Leather

#### 2 Back Surface:

- 2 Fabric
- 3 Faux Leather

#### 3 Glide Style:

- H Hard
- F Felt

- 2) Seat fabric surface and color.
- 3) Back fabric surface and color.
- 4) Trim color.

**Note:** For mixed grade surface materials, please refer to the electronic design and specification tools for pricing.

Description	Number			Fabric Grade							
	1	2	3	A	B	C	D	E	F	G	H
No Back	SMCN-	058-HS		\$2942.44	\$3136.34	\$3200.06	\$3289.12	\$3409.20	\$3981.04	\$4240.65	\$4707.93
Mid-Back	SMCM-	58-HS		3709.17	4090.82	4216.17	4389.85	4626.12	5749.28	6684.25	7755.11
High-Back	SMCH-	58-HS		4901.87	5358.99	5510.09	5718.20	6002.18	7350.05	7961.93	9063.34

The following options require modification of the product number.

Stain Repellent

To specify, add **P** to end of the product number; **Example:** SMCN-2058-HSFP  
 (No Back - add \$133.60 list, Mid-Back - add \$258.29 list, High-Back - add \$302.83 list)

\*This product may be subject to supplemental freight charges.

# Riverbend

Curved — Convex\*

## 60° Convex

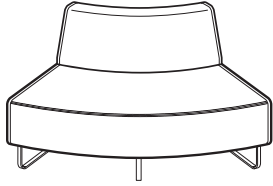

SMVM-2258-HS

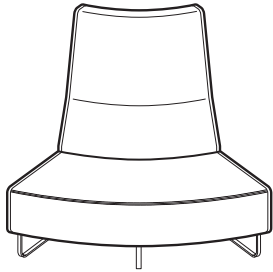

SMVH-2258-HS

### Dimensions

SH: 17.8"(452mm)  
 TH: 30.7"(780mm) -  
 Mid-Back  
 49.6"(1260mm) -  
 High-Back  
 SD: 22.6"(574mm)  
 TD: 33.8"(858mm)  
 TW: 58.3"(3780mm)

### Features

- Includes upholstered seat and back (if applicable) and painted steel legs.
- Seat and back available in same surface and color or different surface and color.
- Available with hard plastic glides or felt glides.
- Convex shape available as 60° only.
- Available with horizontal seam on seat front and back and across the top of the mid-back.
- COM yardage:  
 Mid-Back: 6.0 (seat 3.0/back 3.0)  
 High-Back: 6.75 (seat 3.0/back 3.75)

### Specification Tips

- Fabric applied railroaded.
- Linear or patterned fabric not recommended due to the manner in which fabric is applied.
- Ganging bracket available (ordered separately) to attach adjacent Riverbend products.
- Separately specified power module available for under seat power access.
- For no back version use 60° Curve Concave.
- For accent pillows, refer to Openest Price List.

### To Order, Specify:

1) Product number, including:

#### 1 Seat Surface:

- 2 Fabric
- 3 Faux Leather

#### 2 Back Surface:

- 2 Fabric
- 3 Faux Leather

#### 3 Glide Style:

- H Hard
- F Felt

- 2) Seat fabric surface and color.
- 3) Back fabric surface and color.
- 4) Trim color.

**Note:** For mixed grade surface materials, please refer to the electronic design and specification tools for pricing.

Description	Number			Fabric Grade							
	1	2	3	A	B	C	D	E	F	G	H
Mid-Back	SMVM-	58-HS		\$3757.20	\$4083.23	\$4190.95	\$4338.72	\$4540.85	\$5500.61	\$5936.35	\$6720.72
High-Back	SMVH-	58-HS		4949.89	5317.17	5438.80	5605.98	5833.49	6915.84	7407.18	8291.70

The following options require modification of the product number.

Stain Repellent

To specify, add **P** to end of the product number; **Example:** SMVM-2258-HSFP  
 (Mid-Back - add \$222.65 list, High-Back - add \$249.38 list)

\*This product may be subject to supplemental freight charges.



# Riverbend

Corner — Square\*

## Corner – Square

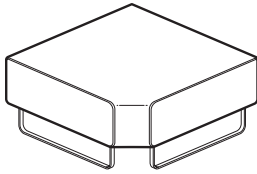

SMQN-2040-H

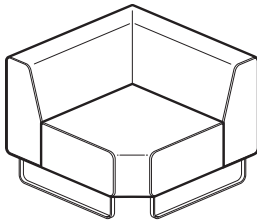

SMQM-2240-H

### Dimensions

SH: 17.8”(452mm)  
 TH: 17.8”(452mm)  
 No Back  
 30.7”(780mm) -  
 Mid-Back  
 SD: 33.8”(858mm)  
 No Back  
 22.6”(574mm) -  
 Mid-Back  
 TD: 33.8”(858mm)  
 TW: 40”(1016mm)

### Features

- Includes upholstered seat and back (if applicable) and painted steel legs.
- Seat and back available in same surface and color or different surface and color.
- Available with hard plastic glides or felt glides.
- Available with or without horizontal seams. When order with horizontal seams there will be a seam across the front of the seat and across the top of the mid-back.
- COM yardage:  
 No Back: 4.0  
 Mid-Back: 7.0 (seat 4.0/back 3.0)

### Specification Tips

- Fabric applied railroaded.
- Linear or patterned fabric not recommended due to the manner in which fabric is applied.
- Ganging bracket available (ordered separately) to attach adjacent Riverbend products.
- Separately specified power module available for under seat power access.
- For accent pillows, refer to Openest Price List.
- **Big Arrow fabric available however will not be pattern matched. Available with horizontal seam only.**

### To Order, Specify:

1) Product number, including:

#### 1 Seat Surface:

- 2 Fabric
- 3 Faux Leather

#### 2 Back Surface:

- 2 Fabric
- 3 Faux Leather

#### 3 Glide Style:

- H Hard
- F Felt

- 2) Seat fabric surface and color.
- 3) Back fabric surface and color.
- 4) Trim color.

**Note:** For mixed grade surface materials, please refer to the electronic design and specification tools for pricing.

Description	Number			Fabric Grade							
	1	2	3	A	B	C	D	E	F	G	H
<b>Without Horizontal Seams</b>											
No Back	SMQN-	040-HN		\$3358.16	\$3526.02	\$3619.59	\$3800.56	\$3978.52	\$4575.23	\$4941.21	\$5632.89
Mid-Back	SMQM-	40-HN		4132.64	4504.55	4729.71	5060.79	5297.80	6251.29	6876.38	8045.27
<b>With Horizontal Seams</b>											
No Back	SMQN-	040-HS		\$3513.05	\$3680.91	\$3774.48	\$3955.45	\$4133.41	\$4730.12	\$5096.10	\$5787.78
Mid-Back	SMQM-	40-HS		4287.53	4659.44	4884.60	5215.68	5452.69	6406.18	7031.27	8200.16

The following options require modification of the product number.

Stain Repellent

To specify, add **P** to end of the product number; **Example:** SMQN-2040-HNFP  
 (No Back - add **\$95.45** list, Mid-Back - add **\$206.19** list)

\*This product may be subject to supplemental freight charges.

# Pebble

Ottoman\*

## Ottoman

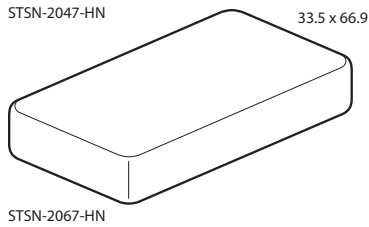
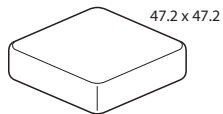
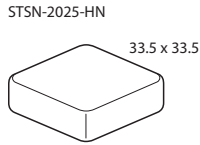
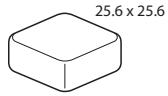

## Features

- Includes one ottoman with glides.
- Glides available in hard plastic or felt.
- COM yardage:
  - Square - Small: 3.0
  - Square - Medium: 3.75
  - Square - Large: 5.25
  - Rectangle: 6.1

## Specification Tips

- Fabric applied railroaded.
- Linear or patterned fabric not recommended due to the manner in which fabric is applied.

## To Order, Specify:

1) Product number, including:

### 1 Surface Material:

- 2 Fabric
- 3 Faux Leather

### 2 Glide Style:

- H Hard
- F Felt

2) Surface material and color.

Description	Height	Depth	Width	Number		Fabric Grade							
				1	2	A	B	C	D	E	F	G	H
Square - Small	16.9"(429mm)	25.6"(650mm)	25.6"(650mm)	STSN-025-HN		\$1332.11	\$1487.56	\$1538.00	\$1609.13	\$1698.05	\$2147.96	\$2351.86	\$2718.90
Square - Medium		33.5"(851mm)	33.5"(851mm)	STSN-033-HN		1562.91	1763.59	1828.94	1920.78	2044.22	2638.05	2906.78	3390.48
Square - Large		47.2"(1199mm)	47.2"(1199mm)	STSN-047-HN		2628.59	2905.71	2997.11	3123.18	3292.73	4111.60	4482.27	5149.46
Rectangle		33.5"(851mm)	66.9"(1699mm)	STSN-067-HN		2602.26	2924.59	3030.92	3177.69	3381.78	4344.56	5143.01	6057.52

The following options require modification of the product number.

Stain Repellent

To specify, add **P** to end of the product number; **Example:** STSN-2025-HNFP

(Square - Small - add **\$106.87** list, Square - Medium - add **\$133.60** list, Square - Large - add **\$187.04** list, Rectangle - add **\$217.32** list)

\*This product may be subject to supplemental freight charges.

# Riverbend Accessories

## Ganging Bracket

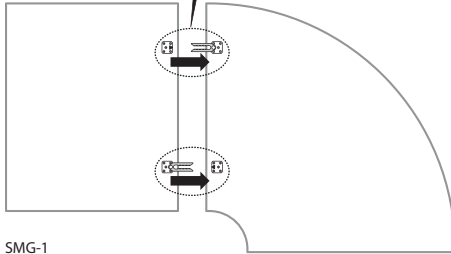
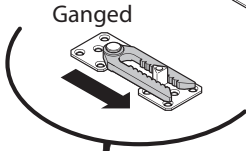
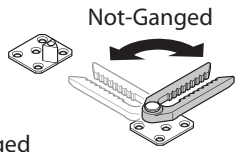

SMG-1

### Features

- Includes 2 brackets, screws, assembly instructions and template.
- Available in black only.

### Specification Tip

- Used to gang two Riverbend components together.

### To Order, Specify:

- 1) Product number.  
(No finish specification required.)

	Number	Price
	SMG-1	\$170.38

# Riverbend Power Module

## Corded

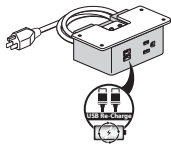

EUSM-PFOW-1100  
EUSM-PLOW-1100

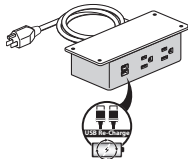

EUSM-PFOW-2100  
EUSM-PLOW-2100



## Features

- Includes power module, two cord management clips, mounting brackets and attachment hardware.
- Power module consists of either one or two simplex outlets (NEMA-5-15R) and one dual USB port.

## Specification Tips

- Power module attaches to the front edge of the Riverbend components.
- Power modules cannot be daisy chained together.
- Application may require approval from local authority having jurisdiction (AHJ); ensure compliance before placing orders and installing.

## To Order, Specify:

1) Product number, including:

### 1 Color:

**B** Black

**W** White

Description	Number <sup>1</sup>	Price
<b>6' Cord</b>		
One Simplex Outlet	EUSM-PFO <span style="background-color: #cccccc;">■</span> -1100	<b>\$568.54</b>
Two Simplex Outlets	EUSM-PFO <span style="background-color: #cccccc;">■</span> -2100	<b>582.90</b>
<b>12' Cord</b>		
One Simplex Outlet	EUSM-PL0 <span style="background-color: #cccccc;">■</span> -1100	<b>\$611.68</b>
Two Simplex Outlets	EUSM-PL0 <span style="background-color: #cccccc;">■</span> -2100	<b>626.04</b>

## Hardwire

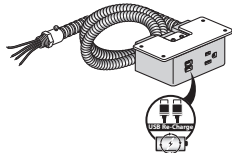

EUSM-HFOW-1100  
EUSM-HLOW-1100

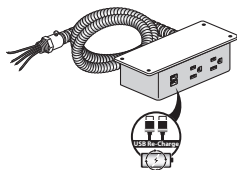

EUSM-HFOW-2100  
EUSM-HLOW-2100



## Features

- Includes power module, two cord management clips, mounting brackets and attachment hardware.
- Power module consists of either one or two simplex outlets (NEMA-5-15R) and one dual USB port.

## Specification Tips

- Power module attaches to the front edge of the Riverbend components.
- Power modules cannot be daisy chained together.
- Application may require approval from local authority having jurisdiction (AHJ); ensure compliance before placing orders and installing.

## To Order, Specify:

1) Product number, including:

### 1 Color:

**B** Black

**W** White

<b>6' Cord</b>		
One Simplex Outlet	EUSM-HFO <span style="background-color: #cccccc;">■</span> -1100	<b>\$676.50</b>
Two Simplex Outlets	EUSM-HFO <span style="background-color: #cccccc;">■</span> -2100	<b>690.86</b>
<b>12' Cord</b>		
One Simplex Outlet	EUSM-HLO <span style="background-color: #cccccc;">■</span> -1100	<b>\$719.64</b>
Two Simplex Outlets	EUSM-HLO <span style="background-color: #cccccc;">■</span> -2100	<b>734.00</b>

# Openest Collection

## Plume Screens

### Plume 3

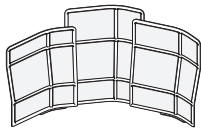

SON-3

#### Dimensions

H: 65"(1651mm)  
 D: 34.5"(876mm)  
 W: 125.75"(3194mm)  
 (Outside)  
 113.5"(2883mm)  
 (Inside)

#### Features

- Includes:  
 (1) 57"(1448mm)H x 50"(1270mm)W screen,  
 (1) 65"(1651mm)H x 50"(1270mm)W screen,  
 (1) 61"(1549mm)H x 50"(1270mm)W screen.
- All screens are connected together, not interchangeable.
- Available in King II, Class II and Maya II fabrics only; COM not available.
- Floor support and screen connectors in same color.

#### To Order, Specify:

- 1) Product number.
- 2) Inner material.
- 3) Outer Material.
- 4) Trim color.

	Number	Fabric Grade C	D
	SON-3	\$13128.89	\$15148.73

### Plume 6

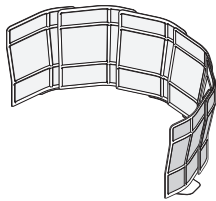

SON-6

#### Dimensions

H: 57"(1448mm)  
 D: 84"(2134mm)  
 W: 143.75"(3651mm)  
 (Outside)  
 132"(3353mm)  
 (Inside)

#### Features

- Includes:  
 (6) 57"(1448mm)H x 50"(1270mm)W screens.
- All screens are connected together, not interchangeable.
- Available in King II, Class II and Maya II fabrics only; COM not available.
- Floor support and screen connectors in same color.

#### To Order, Specify:

- 1) Product number.
- 2) Inner material.
- 3) Outer Material.
- 4) Trim color.

	SON-6	\$25247.80	\$28614.22
--	-------	------------	------------

### Plume 9

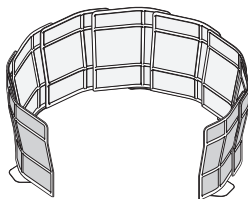

SON-9

#### Dimensions

H: 57"(1448mm)  
 D: 128.5"(3264mm)  
 W: 146.75"(3727mm)  
 (Outside)  
 131.25"(3334mm)  
 (Inside)

#### Features

- Includes:  
 (9) 57"(1448mm)H x 50"(1270mm)W screens.
- All screens are connected together, not interchangeable.
- Available in King II, Class II and Maya II fabrics only; COM not available.
- Floor support and screen connectors in same color.

#### To Order, Specify:

- 1) Product number.
- 2) Inner material.
- 3) Outer Material.
- 4) Trim color.

	SON-9	\$37871.78	\$42079.76
--	-------	------------	------------

**Note:** For mixed grade fabric surfaces, pricing will be determined by the sum of the upcharges. Please refer to the electronic design and specification tools for these prices.

**Note:** The Openest Plume screen is made with polyester fabric adhered to a polyester core. The screen is compliant with UL-1286 flammability requirements and California Technical Bulletin TB-117-2013 requirements. The fabric covering is compliant with NFPA 701 requirements. Consult your local code authority to assure that screens are compliant prior to installation.

**Note:** For additional Openest products, details and specifications please refer to the Openest Price List.

# Openest Collection

## Feather Sofa\*

### Feather – Symmetrical

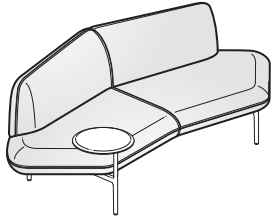

SOSS-1-RW

#### Dimensions

##### Sofa

SH: 16.5"(419mm)  
 TH: 30.25"(768mm)  
 SD: 25"(635mm)  
 TD: 37"(940mm)  
 W: 87"(2210mm)

##### Table

H: 19.5"(495mm)  
 D: 15.75"(400mm)

#### Features

- Includes: Sofa with specifiable top-stitch thread and optional side mount table.
- Legs: Painted cast aluminum.
- Optional table:
  - Can be right-side or left-side mounted.
  - Rotates 360°
  - Available in Black, Polar, Stormy or Vapor painted MDF or planked wood in White Oak or Walnut.
  - Planked wood tops are designed to be unique, using solid wood planks with a clear, low-gloss finish showing natural variation.
- COM yardage: 6.5

#### To Order, Specify:

1) Product number, including:

##### 1 Surface Material:

- 1** Leather
- 2** Fabric
- 3** Faux Leather

##### 2 Table Option:

- N** No Table
- R** Right Hand Table
- L** Left Hand Table

- 2) Surface color.
- 3) Thread color.
- 4) Leg color.
- 5) Table finish (if applicable).

#### Specification Tips

- Fabric will be applied railroaded.
- Linear or patterned fabric is not recommended due to the manner in which fabric is applied.

Description	Number 1 2	Fabric Grade		C	D	E	F	G	H	Leather Grade A	Leather Grade B
		A	B								
Without Table	SOSS- -N	\$5049.57	\$5335.71	\$5655.51	\$5891.16	\$6396.13	\$6648.59	\$7195.63	\$7363.96	\$ 9972.89	\$11992.73
With Painted MDF Table	SOSS- - P	6042.64	6328.78	6648.58	6884.23	7389.20	7641.66	8188.70	8357.03	10965.96	12985.80
With Wood Table - White Oak	SOSS- - W	6985.22	7271.36	7591.16	7826.81	8331.78	8584.24	9131.28	9299.61	11908.54	13928.38
With Wood Table - Walnut	SOSS- - W	7111.48	7397.62	7717.42	7953.07	8458.04	8710.50	9257.54	9425.87	12034.80	14054.64

The following options require modification of the product number.

Stain Repellent

To specify, add **-P** to the end of the product number; **Example: SOSS-2-NP** (add \$251.28 list)  
 For sofa without table add **OP** to the end of the product number. **Example: SOSS-2-NOP**

### Feather – Asymmetrical

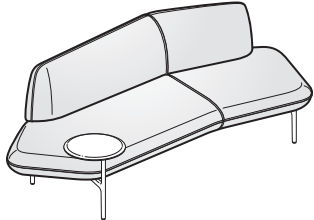

SOSR-1-RW

#### Dimensions

##### Sofa

SH: 16.5"(419mm)  
 TH: 30.25"(768mm)  
 SD: 25"(635mm)  
 TD: 37"(940mm)  
 W: 92"(2337mm)

##### Table

H: 19.5"(495mm)  
 D: 15.75"(400mm)

#### Features

- Includes: Sofa with specifiable top-stitch thread and optional side mount table.
- Legs: Painted cast aluminum.
- Optional table:
  - Can be right-side or left-side mounted.
  - Rotates 360°
  - Available in Black, Polar, Stormy or Vapor painted MDF or planked wood in White Oak or Walnut.
  - Planked wood tops are designed to be unique, using solid wood planks with a clear, low-gloss finish showing natural variation.
- COM yardage: 6.75

#### To Order, Specify:

1) Product number, including:

##### 1 Handedness:

- R** Right hand
- L** Left hand

##### 2 Surface Material:

- 1** Leather
- 2** Fabric
- 3** Faux Leather

##### 3 Table Option:

- N** No Table
- R** Right Hand Table
- L** Left Hand Table

- 2) Surface color.
- 3) Thread color.
- 4) Leg color.
- 5) Table finish (if applicable).

#### Specification Tips

- Fabric will be applied railroaded.
- Linear or patterned fabric is not recommended due to the manner in which fabric is applied.
- Handedness determined when seated on sofa.

Description	Number 1 2 3	Fabric Grade		C	D	E	F	G	H	Leather Grade A	Leather Grade B
		A	B								
Without Table	SOS - -N	\$5133.72	\$5436.70	\$5764.93	\$6101.55	\$6606.50	\$6901.08	\$7490.19	\$7616.44	\$10048.62	\$12118.96
With Painted MDF Table	SOS - - P	6126.79	6429.77	6758.00	7094.62	7599.57	7894.15	8483.26	8609.51	11041.69	13112.03
With Wood Table - White Oak	SOS - - W	7069.37	7372.35	7700.58	8037.20	8542.15	8836.73	9425.84	9552.09	11984.27	14054.61
With Wood Table - Walnut	SOS - - W	7195.63	7498.61	7826.84	8163.46	8668.41	8962.99	9552.10	9678.35	12110.53	14180.87

The following options require modification of the product number.

Stain Repellent

To specify, add **P** to the end of the product number; **Example: SOSR-2-NP** (add \$251.28 list)  
 For sofa without table add **OP** to the end of the product number. **Example: SOSR-2-NOP**

**Note:** For additional Openest products, details and specifications please refer to the Openest Price List.

\*This product may be subject to supplemental freight charges.

# Openest Collection

## Chick Pouf

### Chick Pouf with Back

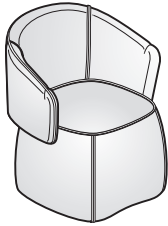

SOPB-2223

#### Dimensions

SH: 18"(457mm)  
 TH: 37.75"(959mm)  
 SD: 18.75"(476mm)  
 TD: 25.2"(640mm)  
 W: 26"(660mm)

#### Features

- Includes: Seat and back with specifiable top-stitch thread and puck colors.
- Seat back flips up and down.
- Pull tab to flip back up or down available in orange only.
- COM yardage:  
 Inner/Outer surfaces matching: 3.5  
 Inner Back and Seat only: 1.5  
 Outer Back and Base only: 2.0

#### Specification Tip

- Linear or patterned fabric is not recommended due to the manner in which fabric is applied.

#### To Order, Specify:

- 1) Product number, including:

#### 1 Inner Surface Material:

- 1 Leather
- 2 Fabric
- 3 Faux Leather

#### 2 Outer Surface Material:

- 1 Leather
- 2 Fabric
- 3 Faux Leather

- 2) Inner Surface Color (Seat, inside back).

- 3) Outer Surface Color (Base, outer back).

- 4) Thread color.

- 5) Puck color.

Number 1 2	Fabric Grade		C	D	E	F	G	H	Leather Grade A	Leather Grade B
	A	B								
SOPB- 23-00H	\$2945.54	\$3113.86	\$3341.14	\$3551.52	\$3888.14	\$4064.90	\$4460.38	\$4586.66	\$5554.54	\$6606.48

### Chick Pouf without Back

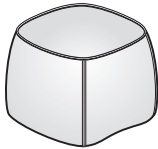

SOPN-2223

#### Dimensions

H: 18"(457mm)  
 D: 22.5"(572mm)  
 W: 23.25"(591mm)

#### Features

- Includes: Seat/Base only with specifiable top-stitch thread color.
- COM yardage:  
 Seat and Base matching: 2.0  
 Seat only: .75  
 Base only: 2.0

#### Specification Tip

- Linear or patterned fabric is not recommended due to the manner in which fabric is applied.

#### To Order, Specify:

- 1) Product number, including:

#### 1 Seat Surface Material:

- 1 Leather
- 2 Fabric
- 3 Faux Leather

#### 2 Base Surface Material:

- 1 Leather
- 2 Fabric
- 3 Faux Leather

- 2) Inner Surface Color (Seat).

- 3) Outer Surface Color (Base).

- 4) Thread color.

Number 1 2	Fabric Grade		C	D	E	F	G	H	Leather Grade A	Leather Grade B
	A	B								
SOPN- 23-00H	\$1422.30	\$1514.82	\$1657.90	\$1809.42	\$2011.36	\$2127.51	\$2398.51	\$2465.83	\$3281.05	\$4078.89

The following options require modification of the product number.

Stain Repellent

To specify, add **-P** to the end of the product number; **Example:** SOPB-2223-**P**; SOPN-2223-**P** (add **\$126.48** list for Chick Pouf with Back or **\$72.29** for Chick Pouf without Back)

For mixed grade fabric surfaces, please refer to the electronic design and specification tools for these prices.

# Openest Collection

## Chick Pouf

### Large Square - No Back

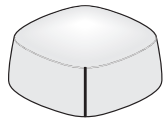

SOPN-2238

#### Dimensions

H: 17"(432mm)  
D: 38"(965mm)  
W: 38"(965mm)

#### Features

- Includes: Seat and base with specifiable top-stitch thread around the top and down the corners.
- Available with black hard or felt glides.
- COM yardage:  
Seat and Base matching: 4.0  
Seat only: 1.3  
Base only: 2.6

#### Specification Tips

- Fabric will be applied railroaded.
- Linear or patterned fabric is not recommended due to the manner in which fabric is applied.

#### To Order, Specify:

1) Product number, including:

#### 1 Seat Surface Material:

- 1 Leather
- 2 Fabric
- 3 Faux Leather

#### 2 Base Surface Material:

- 1 Leather
- 2 Fabric
- 3 Faux Leather

#### 3 Glide Option:

- H Hard Glides
- K Felt Glides

- 2) Seat surface color.  
3) Base surface color.  
4) Thread color.

Number 1 2 3	Fabric Grade		C	D	E	F	G	H	Leather Grade A	Leather Grade B
	A	B								
SOPN- 38-00	\$2039.70	\$2175.68	\$2311.64	\$2453.32	\$2583.60	\$3195.53	\$3535.45	\$4147.38	\$3908.67	\$4565.88

### Rectangle - No Back

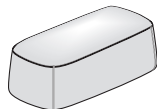

SOPN-2252

#### Dimensions

H: 18"(457mm)  
D: 27"(686mm)  
W: 52"(1321mm)

#### Features

- Includes: Seat and base with specifiable top-stitch thread around the top and down the corners.
- Available with black hard or felt glides.
- COM yardage:  
Seat and Base matching: 4.6  
Seat only: 2.0  
Base only: 2.6

#### Specification Tips

- Fabric will be applied railroaded.
- Linear or patterned fabric is not recommended due to the manner in which fabric is applied.

#### To Order, Specify:

1) Product number, including:

#### 1 Seat Surface Material:

- 1 Leather
- 2 Fabric
- 3 Faux Leather

#### 2 Base Surface Material:

- 1 Leather
- 2 Fabric
- 3 Faux Leather

#### 3 Glide Option:

- H Hard Glides
- K Felt Glides

- 2) Seat surface color.  
3) Base surface color.  
4) Thread color.

Number 1 2 3	Fabric Grade		C	D	E	F	G	H	Leather Grade A	Leather Grade B
	A	B								
SOPN- 52-00	\$2402.31	\$2560.95	\$2719.58	\$2884.87	\$3036.89	\$3750.02	\$4147.34	\$4861.26	\$4389.11	\$5078.07

The following options require modification of the product number.

Stain Repellent

To specify, add **P** to the end of the product number; **Example:** SOPN-2238-00HP  
(Large Square add **\$104.25** list; Rectangle add **\$122.38** list)

For mixed grade fabric surfaces, please refer to the electronic design and specification tools for these prices.



# Openest Collection

Chick Pouf

## Round - No Back

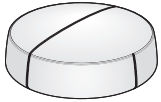

SOPN-2265

### Dimensions

H: 17"(432mm)  
D: 65"(1651mm)

### Features

- Includes: Seat and base with specifiable top-stitch thread around the top, across the middle of the top, and four vertical seams (every 90°).
- Available with black hard or felt glides or six black braking casters.
- Braking casters lock into place when weight is loaded on the pouf.
- COM yardage:
  - Seat and Base matching: 8.0
  - Seat only: 4.0
  - Base only: 4.0

### Specification Tips

- Fabric will be applied railroaded.
- Linear or patterned fabric is not recommended due to the manner in which fabric is applied.

### To Order, Specify:

1) Product number, including:

#### 1 Seat Surface Material:

- 2 Fabric
- 3 Faux Leather

#### 2 Base Surface Material:

- 2 Fabric
- 3 Faux Leather

#### 3 Glide/Caster Option:

- H Hard Glides
- K Felt Glides
- B Braking Casters (add \$530.96 list)

2) Seat surface color.

3) Base surface color.

4) Thread color.

Number	Fabric Grade			C	D	E	F	G	H	Leather Grade A	Leather Grade B		
	1	2	3									A	B
SOPN-■ ■ 65-00 ■				\$4441.97	\$4713.93	\$4985.91	\$5269.17	\$5529.77	\$6753.61	\$7433.51	\$8657.31	N/A	N/A

The following options require modification of the product number.

Stain Repellent

To specify, add **P** to the end of the product number; **Example:** SOPN-2265-00HP (add \$208.51 list)

For mixed grade fabric surfaces, please refer to the electronic design and specification tools for these prices.

# Openest Collection

## Sprig Tables

### Rectangle

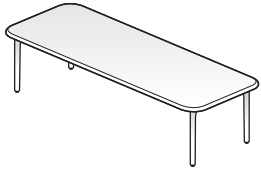

SORA-5320-P

### Features

- Includes: Table top and legs.
- Top available in Black, Polar, Stormy, or Vapor painted MDF or planked wood in White Oak or Walnut.
- Planked wood tops are designed to be unique, using solid wood planks with a clear, low-gloss finish showing natural variation.
- Legs: Painted cast aluminum.

### To Order, Specify:

1) Product number, including:

#### ① Surface Material:

- P** Painted MDF
- W** Planked Wood

2) Top color.

3) Leg color.

Height	Depth	Width	Number ①	Painted	White Oak	Walnut
12"(305mm)	20"(508mm)	53"(1346mm)	SORA-5320-■	<b>\$1397.06</b>	<b>\$3492.64</b>	<b>\$4250.06</b>

### Round



SODC-1616-P



SODB-2424-P

### Features

- Includes: Table top and legs.
- Top available in Black, Polar, Stormy, or Vapor painted MDF or planked wood in White Oak or Walnut.
- Planked wood tops are designed to be unique, using solid wood planks with a clear, low-gloss finish showing natural variation.
- Legs: Painted cast aluminum.

### To Order, Specify:

1) Product number, including:

#### ① Surface Material:

- P** Painted MDF
- W** Planked Wood

2) Top color.

3) Leg color.

Height	Diameter	Number ①	Painted	White Oak	Walnut
17"(432mm)	16"(406mm)	SODC-1616-■	<b>\$ 993.07</b>	<b>\$2019.82</b>	<b>\$2188.15</b>
14"(356mm)	24"(610mm)	SODB-2424-■	<b>\$1094.06</b>	<b>\$2709.93</b>	<b>\$3113.87</b>

**Note:** For additional Openest products, details and specifications please refer to the Openest Price List.

# Pip

## Personal Laptop Table



STP-P26-TH

### Features

- Includes table top, base and hardware.
- Top available in painted MDF or planked wood in White Oak or Walnut.
- Wood tops are designed to be unique using solid wood planks with a clear, low-gloss finish showing natural variation.
- Base: Painted aluminum support plate and column with painted steel base plate.
- Ships unassembled.

### To Order, Specify:

1) Product number, including:

#### ① Surface Material:

- P** Painted MDF
- W** Planked Wood

#### ② Glide Type:

- H** Hard Plastic
- F** Felt

2) Top surface and color.

3) Base trim color.

Height	Depth	Width	Number		Painted MDF	White Oak	Walnut
			①	②			
26"(660mm)	13"(330mm)	21.25"(540mm)	STP-	26-T	<b>\$790.87</b>	<b>\$1437.27</b>	<b>\$1615.98</b>

This page intentionally blank

# Poppy-At-A-Glance

**Designer** Patricia Urquiola

**Fabric** Linear or patterned fabric not recommended due to the manner in which the material is applied. Because of the nature of the chair, materials that have more fibers or woolen spun yarn construction, such as Cotswold, tend to upholster well on Poppy. Synthetic fibers, or textiles with heavy back coatings, tend to be more difficult to upholster and consequently may restrict some COMs.

## Guest Seating

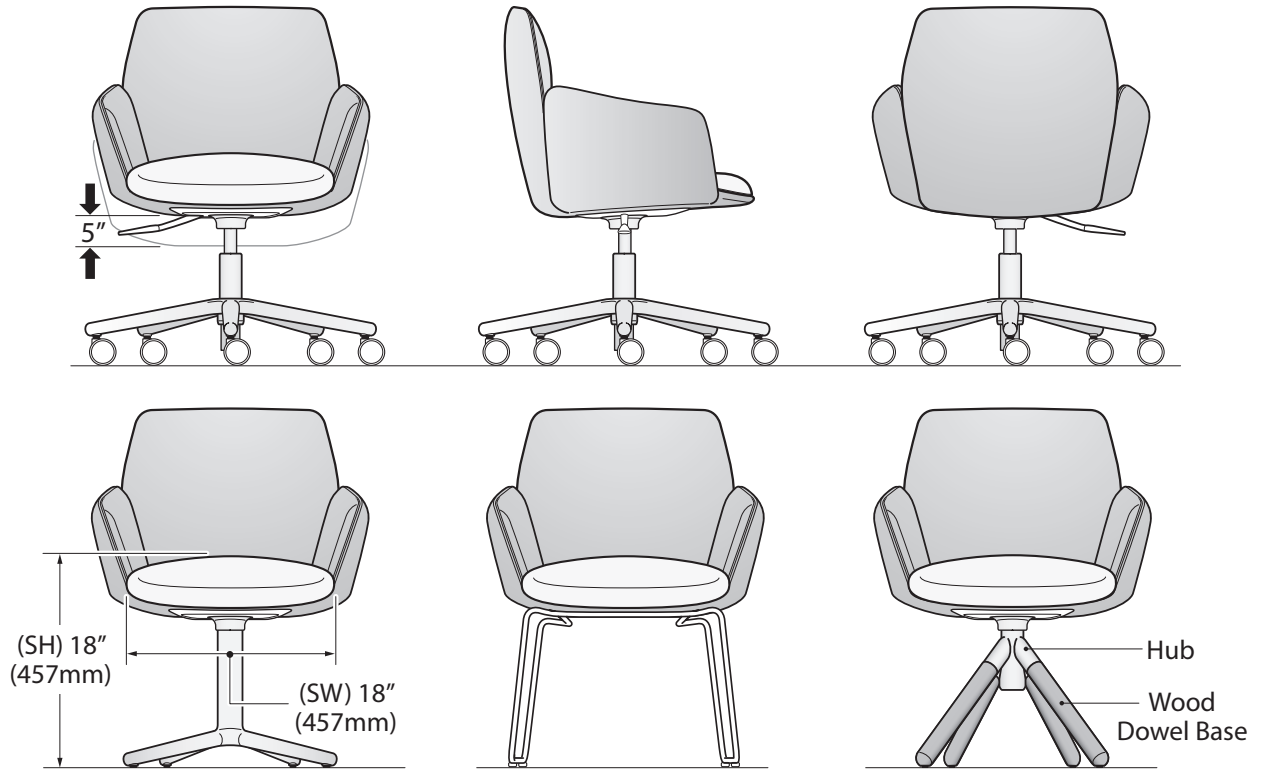

## Lounge Seating

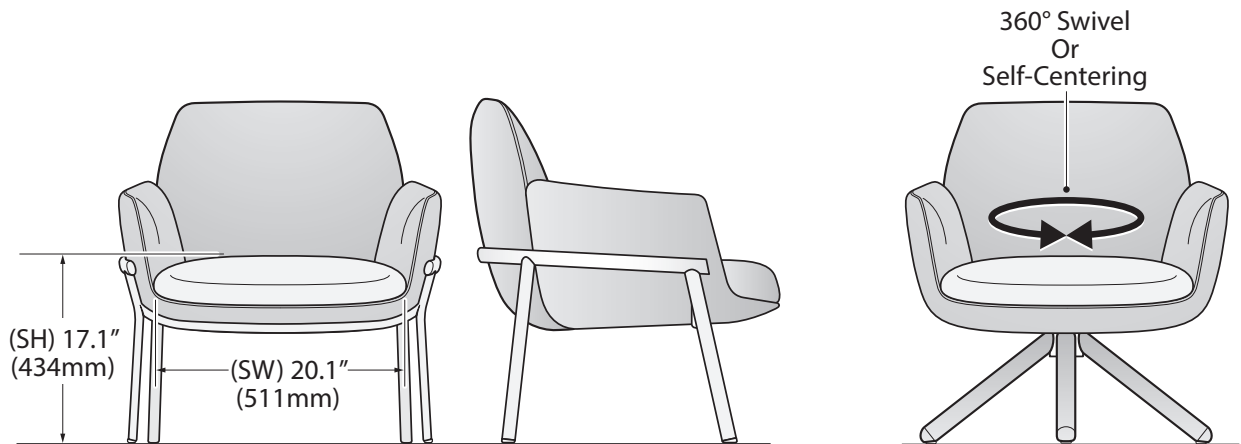

# Poppy

Guest

## Four Star Base with Glides



SPG-11-4

### Dimensions

SH: 18"(457mm)  
 H: 33"(838mm)  
 D: 26.75"(679mm)  
 W: 26.75"(679mm)  
 SW: 18"(457mm)  
 SD: 18"(457mm)  
 AH: 25"(635mm)

### Features

- Back and arms: Upholstered in matching upholstery.
- Seat: Standard upholstered. Upholstery can match or complement back and arms.
- Base: Four star aluminum base.  
 –Standard with glides; felt pads included  
 –Available in Black (TR-F) or Smooth Plaster (TR-PLS)
- Seat swivels 360°.
- COM yardage / COL square footage: 2.0/55  
 Back/Arms: 1.5/40  
 Seat: 0.5/15

### Specification Tip

- Linear or patterned fabric is not recommended due to the manner in which fabric is applied.

### To Order, Specify:

- 1) Product number, including;

#### ① Seat Upholstery:

- 1 Leather
- 2 Fabric
- 3 Faux Leather

#### ② Back/Arm Upholstery:

- 1 Leather
- 2 Fabric
- 3 Faux Leather

- 2) Seat surface and color.
- 3) Back/arm surface and color.
- 4) Trim color.  
 TR-F Black  
 TR-PLS Smooth Plaster, add **\$92.31** list.

Number ① ②	Fabric Grade		C	D	E	F	G	H	Leather Grade A	Leather Grade B
	A	B								
SPG-■■■-4	\$2512.81	\$2625.55	\$2722.18	\$2859.15	\$3020.22	\$3100.73	\$3141.00	\$3221.53	\$3165.17	\$3342.34

## Five Star Base with Casters



SPG-11-5

### Dimensions

SH: 16"-21"  
 (406mm-533mm)  
 H: 31"-36"  
 (787mm-914mm)  
 D: 26.75"(679mm)  
 W: 26.75"(679mm)  
 SW: 18"(457mm)  
 SD: 18"(457mm)  
 AH: 23"-28"  
 (584mm-711mm)

### Features

- Back and arms: Upholstered in matching upholstery.
- Seat: Standard upholstered. Upholstery can match or complement back and arms.
- Base: Five star aluminum base.  
 –Available in Black (TR-F) or Smooth Plaster (TR-PLS)  
 –Casters match base color; Smooth Plaster casters are two-tone with graphite tread.
- Soft casters available in black only.
- Seat swivels 360°.
- Pneumatic height adjustment of 5"(127mm).
- Tablet option:  
 –Tablet arm available right or left handed.  
 –Dual-pivot tablet rotates 360° at both the arm's pivot joint and tablet surface connection point  
 –Tablet surface is 11.5"(292mm)D x 19"(483mm)W and 0.75"(19mm) thick.  
 –Tablet surface available in painted MDF, laminate and wood in White Oak or Walnut
- COM yardage / COL square footage: 2.0/55  
 Back/Arms: 1.5/40  
 Seat: 0.5/15

### Specification Tip

- Linear or patterned fabric is not recommended due to the manner in which fabric is applied.
- Handedness can be changed in the field however, tablet option cannot be added or removed in the field.
- Pivot arm/tablet will need to be field installed to the support arm.

### To Order, Specify:

- 1) Product number, including;

#### ① Seat Upholstery:

- 1 Leather
- 2 Fabric
- 3 Faux Leather

#### ② Back/Arm Upholstery:

- 1 Leather
- 2 Fabric
- 3 Faux Leather

#### ③ Tablet Option (if applicable):

- R Right Hand
- L Left Hand

- 2) Seat surface and color.
- 3) Back/arm surface and color.
- 4) Base trim color.  
 TR-F Black  
 TR-PLS Smooth Plaster, add **\$92.31** list.
- 5) Tablet surface color (if applicable).
- 6) Tablet arm trim color (if applicable).  
 TR-F Black  
 TR-PLS Smooth Plaster

Description	Number ① ② ③	Fabric Grade		C	D	E	F	G	H	Leather Grade A	Leather Grade B
		A	B								
No Tablet	SPG-■■■-5	\$2657.79	\$2770.53	\$2867.16	\$3004.13	\$3165.20	\$3245.71	\$3285.98	\$3366.51	\$3310.15	\$3487.32
Painted MDF*	SPG-■■■-5 P	\$349.98	\$462.72	\$559.35	\$696.32	\$857.39	\$937.90	\$978.17	\$1058.70	\$1002.34	\$1179.51
Laminate - Grade A*	SPG-■■■-5 L	\$535.39	\$648.13	\$744.76	\$881.73	\$1042.79	\$1123.31	\$1163.59	\$1244.12	\$1187.76	\$1364.92
Laminate - Grade B*	SPG-■■■-5 L	\$553.93	\$666.67	\$763.30	\$900.28	\$1061.34	\$1141.85	\$1182.13	\$1262.66	\$1206.30	\$1383.47
Wood - White Oak*	SPG-■■■-5 W	\$536.60	\$649.34	\$745.97	\$882.94	\$1044.01	\$1124.52	\$1164.79	\$1245.32	\$1188.96	\$1366.13
Wood - Walnut*	SPG-■■■-5 W	\$429.30	\$472.04	\$483.67	\$497.64	\$513.71	\$521.22	\$527.49	\$538.02	\$528.66	\$545.83

The following options require modification of the product number.

- Soft Casters
- Stain Repellent

Change the 6th digit in the product number to **6**, and add **\$65.80** list. **Example:** SPG-22-6  
 To specify, add **P** to the end of the product number; **Example:** SPG-22-5P (add **\$99.00** list)

# Poppy

Guest

### Sled Base



SPG-11-7

#### Dimensions

SH: 18"(457mm)  
 H: 33"(838mm)  
 D: 24.25"(616mm)  
 W: 24.25"(616mm)  
 SW: 18"(457mm)  
 SD: 18"(457mm)  
 AH: 25"(635mm)

#### Features

- Back and arms: Upholstered in matching upholstery.
- Seat: Standard upholstered. Upholstery can match or complement back and arms.
- Base: Sled base painted in Black (TR-F) or Smooth Plaster (TR-PLS).
- Glides: Available in felt or hard plastic.
- COM yardage / COL square footage: 2.0/55  
 Back/Arms: 1.5/40  
 Seat: 0.5/15

#### To Order, Specify:

1) Product number, including;

#### 1 Seat Upholstery:

- 1 Leather
- 2 Fabric
- 3 Faux Leather

#### 2 Back/Arm Upholstery:

- 1 Leather
- 2 Fabric
- 3 Faux Leather

#### 3 Glide Styles:

- 7 Hard
- 8 Felt

- 2) Seat surface and color.  
 3) Back/arm surface and color.  
 4) Trim color.  
 TR-F Black  
 TR-PLS Smooth Plaster, add **\$92.31** list.

Number 1 2 3	Fabric Grade			D	E	F	G	H	Leather Grade A	Leather Grade B
	A	B	C							
SPG- <span style="display: inline-block; width: 10px; height: 10px; background-color: #ccc; border: 1px solid #000;"></span> <span style="display: inline-block; width: 10px; height: 10px; background-color: #ccc; border: 1px solid #000;"></span> <span style="display: inline-block; width: 10px; height: 10px; background-color: #ccc; border: 1px solid #000;"></span> (M)	\$2104.25	\$2216.99	\$2313.62	\$2450.59	\$2611.66	\$2692.17	\$2732.44	\$2812.97	\$2756.61	\$2933.78

(M) Product marked with this symbol available as GSA Open Market.

### Wood Base



SPG-11-W

#### Dimensions

SH: 18"(457mm)  
 H: 33"(838mm)  
 D: 24.25"(616mm)  
 W: 24.25"(616mm)  
 SW: 18"(457mm)  
 SD: 18"(457mm)  
 AH: 25"(635mm)

#### Features

- Back and arms: Upholstered in matching upholstery.
- Seat: Standard upholstered. Upholstery can match or complement back and arms.
- Base: Wooden dowel legs with painted aluminum hub.  
 –Wooden legs available in Clear on Oak (M5-W35), Clear on Walnut (M6-W35) and Ink on Ash (M7-W43)  
 –Wooden legs standard with glides; felt pads included  
 –Hub available in Black (TR-F) or Smooth Plaster (TR-PLS)
- Seat swivels 360°.
- COM yardage / COL square footage: 2.0/55  
 Back/Arms: 1.5/40  
 Seat: 0.5/15

#### To Order, Specify:

1) Product number, including;

#### 1 Seat Upholstery:

- 1 Leather
- 2 Fabric
- 3 Faux Leather

#### 2 Back/Arm Upholstery:

- 1 Leather
- 2 Fabric
- 3 Faux Leather

- 2) Seat surface and color.  
 3) Back/arm surface and color.  
 4) Trim color.  
 TR-F Black  
 TR-PLS Smooth Plaster, add **\$67.14** list.  
 5) Wood finish.

#### Specification Tip

- Linear or patterned fabric is not recommended due to the manner in which fabric is applied.

Description	Number 1 2	Fabric Grade			D	E	F	G	H	Leather Grade A	Leather Grade B
		A	B	C							
Ink on Ash	SPG- <span style="display: inline-block; width: 10px; height: 10px; background-color: #ccc; border: 1px solid #000;"></span> <span style="display: inline-block; width: 10px; height: 10px; background-color: #ccc; border: 1px solid #000;"></span> -W	\$3261.84	\$3374.58	\$3471.21	\$3608.18	\$3769.25	\$3849.76	\$3890.03	\$3970.56	\$3914.20	\$4091.37
Clear on Oak	SPG- <span style="display: inline-block; width: 10px; height: 10px; background-color: #ccc; border: 1px solid #000;"></span> <span style="display: inline-block; width: 10px; height: 10px; background-color: #ccc; border: 1px solid #000;"></span> -W	\$3310.16	\$3422.90	\$3519.53	\$3656.50	\$3817.57	\$3898.08	\$3938.35	\$4018.88	\$3962.52	\$4139.69
Clear on Walnut	SPG- <span style="display: inline-block; width: 10px; height: 10px; background-color: #ccc; border: 1px solid #000;"></span> <span style="display: inline-block; width: 10px; height: 10px; background-color: #ccc; border: 1px solid #000;"></span> -W	\$3326.30	\$3439.04	\$3535.67	\$3672.64	\$3833.71	\$3914.22	\$3954.49	\$4035.02	\$3978.66	\$4155.83

The following options require modification of the product number.

Stain Repellent

To specify, add **P** to the end of the product number; **Example:** SPG-22-WP (add **\$99.00** list)

# Poppy

## Lounge

### Basket



SLP-22-T

#### Dimensions

SH: 17.1"(434mm)  
 H: 32.6"(828mm)  
 D: 29.4"(747mm)  
 W: 31"(787mm)  
 SW: 20.1"(511mm)  
 SD: 20.5"(521mm)  
 AH: 24"(610mm)

#### Features

- Back and arms: Upholstered in matching upholstery.
- Seat: Upholstery can match or complement back and arms.
- Base: Four leg painted steel basket frame.  
 –Available in Black (TR-F), Smooth Plaster (TR-PLS), Sable (TR-1M) or Rusty Red (TR-RR).
- Glides: Available in felt or hard plastic.
- COM yardage / COL square footage: 4.0/72  
 Back/Arms: 3.0/54  
 Seat: 1.0/18

#### Specification Tip

- Linear or patterned fabric is not recommended due to the manner in which fabric is applied.

#### To Order, Specify:

- 1) Product number, including;

#### 1 Seat Upholstery:

- 1 Leather
- 2 Fabric
- 3 Faux Leather

#### 2 Back/Arm Upholstery:

- 1 Leather
- 2 Fabric
- 3 Faux Leather

#### 3 Glide Style:

- F Felt
- H Hard

- 2) Seat surface and color.

- 3) Back/arm surface and color.

- 4) Trim color.

TR-F Black  
 TR-1M Sable  
 TR-RR Rusty Red  
 TR-PLS Smooth Plaster, add **\$89.60** list

Number 1 2 3	Fabric Grade			D	E	F	G	H	Leather Grade A	Leather Grade B
	A	B	C							
SLP- - -T -	\$3575.70	\$3779.33	\$3966.68	\$4235.43	\$4471.67	\$5375.77	\$5913.33	\$6890.75	\$7452.78	\$9090.00

### Swivel



SLP-22-S  
 SLP-22-R

#### Dimensions

SH: 17.1"(434mm)  
 H: 32.6"(828mm)  
 D: 29.4"(747mm)  
 W: 31"(787mm)  
 SW: 20.1"(511mm)  
 SD: 20.5"(521mm)  
 AH: 24"(610mm)

#### Features

- Back and arms: Upholstered in matching upholstery.
- Seat: Upholstery can match or complement back and arms.
- Base: Four wooden dowel legs.  
 –Legs available in Clear on Oak (M5-W35), Clear on Walnut (M6-W35) and Ink on Ash (M7-W43).
- Available with 360° or self-centering swivel base.
- Glides: Available in felt or hard plastic.
- COM yardage / COL square footage: 4.0/72  
 Back/Arms: 3.0/54  
 Seat: 1.0/18

#### Specification Tip

- Linear or patterned fabric is not recommended due to the manner in which fabric is applied.

#### To Order, Specify:

#### 1 Seat Upholstery:

- 1 Leather
- 2 Fabric
- 3 Faux Leather

#### 2 Back/Arm Upholstery:

- 1 Leather
- 2 Fabric
- 3 Faux Leather

#### 3 Glide Style:

- F Felt
- H Hard

- 2) Seat surface and color.

- 3) Back/arm surface and color.

- 4) Wood finish

Description	Number 1 2 3	Fabric Grade			D	E	F	G	H	Leather Grade A	Leather Grade B
		A	B	C							
<b>360° Swivel Base</b>											
Ink on Ash	SLP- -S -	\$4325.04	\$4528.67	\$4716.02	\$4984.77	\$5221.01	\$6125.11	\$6662.67	\$7640.09	\$8202.12	\$ 9839.34
Clear on Oak	SLP- -S -	4373.92	4577.55	4764.90	5033.65	5269.89	6173.99	6711.55	7688.97	8251.00	9888.22
Clear on Walnut	SLP- -S -	4455.39	4659.02	4846.37	5115.12	5351.36	6255.46	6793.02	7770.44	8332.47	9969.69
<b>Self-Centering Base</b>											
Ink on Ash	SLP- -R -	\$4365.76	\$4569.39	\$4756.74	\$5025.49	\$5261.73	\$6165.83	\$6703.39	\$7680.81	\$8242.84	\$ 9880.06
Clear on Oak	SLP- -R -	4414.64	4618.27	4805.62	5074.37	5310.61	6214.71	6752.27	7729.69	8291.72	9928.94
Clear on Walnut	SLP- -R -	4496.11	4699.74	4887.09	5155.84	5392.08	6296.18	6833.74	7811.16	8373.19	10010.41

The following options require modification of the product number.

Stain repellent

To specify, add **P** to end of the product number (add **\$149.86** list); **Example:** SLP-22-TFP

**NOTE:** For mixed grade fabrics on seat and back please refer to the electronic design and specification tools for pricing.



# Harbor Work Lounge At-A-Glance

**Designer**

Nicolai Czumaj-Bront of the Haworth Design Studio

**Awards/Achievements**

Best of Neocon 2013: Silver - Seating/Collaborative Work  
 Good Design Award 2013 - Furniture

Inner Shell  
 (Upholstered Only)

Outer Shell  
 (Upholstered,  
 Laminate, Wood Veneer)

**Caster Options:**

- Hard or Soft (Black)
- Hard (Fog & Gray)
- Glide

**Fully Upholstered**

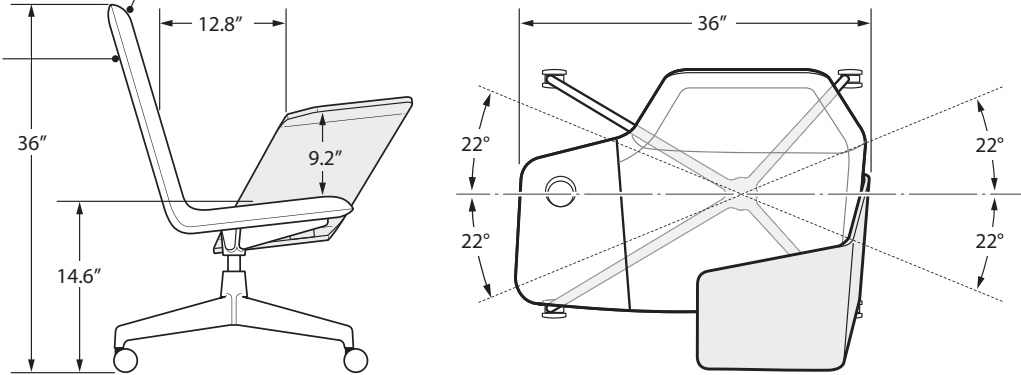

**Cup Holder Fully Upholstered**

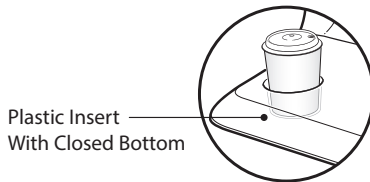

**Cup Holder Partially Upholstered**

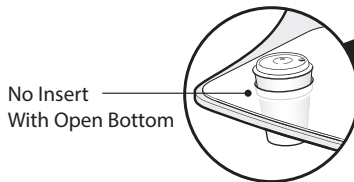

**Partially Upholstered**

Wing:  
 Available as Left  
 or Right handed.  
 Noble Fabric Only

Tablet:  
 Laminate or Wood

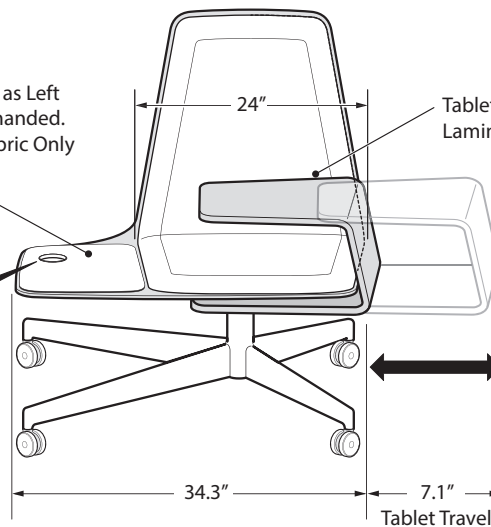

# Harbor Work Lounge

Fully Upholstered, Cast Aluminum Base

## Lounge Chair



SHL-22-1R10



SHL-22-1R12

### Dimensions

SH: 14.6" (371mm)  
 H: 36" (9147mm)  
 W: 35.3" (897mm) w/o tablet  
 36" (914mm) w/tablet  
 SD: 16" (406mm)  
 SW: 24" (610mm)

### Features

- Includes: Upholstered outer and inner shell, right or left wing with cup holder, optional tablet arm and cast aluminum base.
- Fully upholstered lounge chair will be completely upholstered (No laminate or wood veneer visible). Upholstery must be the same material type for inner and outer shell.
- Outer Shell: Upholstered one-piece molded plywood shell.
- Inner Shell: Upholstered molded foam 1.25"(31.75mm) thick.
- Base: Cast-aluminum.
  - Standard painted in Black, Accent Orange, Smooth Plaster or with optional polished aluminum.
  - Swivels 22° in each direction and features a self-returning mechanism.
- Casters: Available with hard black, soft black or hard two-tone.
- Glides: Optional glides ship with plastic and felt tips.
- Seat Wing: Upholstered in Noble performance suede only. Handedness determined by seated position.
- Cup Holder: Available in Chalk or Black plastic.
- Tablet Arm: Optional tablet arm is a one-piece molded plywood form, available in laminate or wood veneer.
  - Laminate finishes include Linen, Putty or Charcoal.
  - Wood veneer finishes include Rift-Cut White Oak or Walnut.
  - Tablet slides 7.1"(180.3mm) to the side.
  - Available in right or left-hand configuration (opposite of seat wing specification).
- COM Yardage / COL square footage  
 Inner/Outer Shell: 2.0/28

### To Order, Specify:

1) Product number, including:

#### 1 Base Option:

- 1** Hard Caster
- 2** Soft Caster, add **\$66.08** list
- T** Two-Tone
- G** Glides, add **\$256.54** list

#### 2 Wing Option:

- R** Right Wing
- L** Left Wing

#### 3 Tablet Option:

- 0** No Tablet
- 1** Wood Tablet, add **\$2441.57** list
- 2** Laminate Tablet, add **\$2441.57** list

- 2) Inner shell material.
- 3) Outer shell material.
- 4) Base color  
Polished aluminum, add **\$132.69** list.
- 5) Wing surface and color.
- 6) Cup holder color.
- 7) Tablet surface and color.

	Number	Fabric Grade									Leather Grade A	Leather Grade B		
		1	2	3	A	B	C	D	E	F			G	H
Leather	SHL-11-	■	■	1 ■	N/A	N/A	N/A	N/A	N/A	N/A	N/A	N/A	\$5502.34	\$5971.18
Fabric	SHL-22-	■	■	1 ■	\$3600.40	\$3720.70	\$3846.35	\$3975.47	\$4168.35	\$4370.02	\$4580.58	\$4803.50	N/A	N/A
Faux Leather	SHL-33-	■	■	1 ■	\$3600.40	\$3720.70	\$3846.35	\$3975.47	\$4168.35	\$4370.02	\$4580.58	\$4803.50	N/A	N/A

# Harbor Work Lounge

Fully Upholstered, Cast Aluminum Base

**Ottoman**



SHO-22-G

**Dimensions**

H: 16.5"-19.5"  
(419mm-495mm)  
D: 17.9" (455mm)  
W: 24.9" (632mm)

**Features**

- Includes: Fully upholstered surface, cup holder and cast aluminum base.
- Fully upholstered ottoman will be completely upholstered (no laminate or wood veneer visible).
- Surface: Upholstered one-piece molded plywood.
- Cushion: Upholstered molded foam 1.25"(31.75mm) thick.
- Cast Aluminum Base: Features 3.0"(76.2mm) height adjustment.  
-Standard painted in Black, Accent Orange, Smooth Plaster or with optional polished aluminum.
- Cup holder: Swing out open hole cup holder standard in polished aluminum.
- Casters: Available with hard black, soft black or hard two-tone.
- Glides: Optional glides ship with plastic and felt tips.
- COM Yardage / COL square footage: 1.0/12

**To Order, Specify:**

- 1) Product number, including:
  - 1** Base Option:
    - 1** Hard Caster
    - 2** Soft Caster, add **\$66.08** list
    - T** Two-Tone
    - G** Glides, add **\$256.54** list
- 2) Surface material.
- 3) Base color  
Polished aluminum, add **\$132.69** list.

	Number <b>1</b>	Fabric Grade		C	D	E	F	G	H	Leather Grade A	Leather Grade B
		A	B								
Leather	SHO-11-	N/A	N/A	N/A	N/A	N/A	N/A	N/A	N/A	\$3648.16	\$3952.47
Fabric	SHO-22-	\$2406.16	\$2485.76	\$2567.16	\$2652.11	\$2777.71	\$2908.62	\$3046.62	\$3191.68	N/A	N/A
Faux Leather	SHO-33-	\$2406.16	\$2485.76	\$2567.16	\$2652.11	\$2777.71	\$2908.62	\$3046.62	\$3191.68	N/A	N/A

# Harbor Work Lounge

Partially Upholstered, Cast Aluminum Base

## Lounge Chair



SHL-25-1L10



SHL-25-1L12

### Dimensions

SH: 14.4" (366mm)  
 H: 35.5" (902mm)  
 W: 34.3" (8714mm) w/o tablet  
 35.5" (902mm) w/tablet  
 SD: 16" (406mm)  
 SW: 24" (610mm)

### Features

- Includes: Laminate or wood veneer outer shell, fabric inner shell, right or left wing with cup holder, optional tablet arm and cast aluminum base.
- Outer Shell: One-piece molded plywood shell with exposed laminate or wood veneer.
- Inner Shell: Upholstered molded foam 1" (25.4 mm) thick with exposed laminate or wood veneer perimeter.
- Base: Cast-aluminum.
  - Standard painted in Black, Accent Orange, Smooth Plaster or with optional polished aluminum.
  - Swivels 22° in each direction and features a self-returning mechanism.
- Casters: Available with hard black, soft black or hard two-tone.
- Glides: Optional glides ship with plastic and felt tips.
- Seat Wing: Upholstered in Noble performance suede only. Handedness determined by seated position.
- Cup Holder: Open hole - no finish options.
- Tablet Arm: Optional tablet arm is a one-piece molded plywood form, available in laminate or wood veneer.
  - Laminate finishes include Linen, Putty or Charcoal.
  - Wood veneer finishes include Rift-Cut White Oak or Walnut.
  - Tablet slides 7.1" (180.3mm) to the side.
  - Available in right or left-hand configuration (opposite of seat wing specification).
- COM Yardage / COL square footage  
 Inner Shell: 1.25/22

### To Order, Specify:

1) Product number, including:

#### 1 Base Option:

- 1** Hard Caster
- 2** Soft Caster, add **\$66.08** list
- T** Two-Tone
- G** Glides, add **\$256.54** list

#### 2 Wing Option:

- R** Right Wing
- L** Left Wing

#### 3 Tablet Option:

- 0** No Tablet
- 1** Wood Tablet, add **\$2441.57** list
- 2** Laminate Tablet, add **\$2441.57** list

- 2) Inner shell material.
- 3) Outer shell material.
- 4) Base color  
Polished aluminum, add **\$132.69** list.
- 5) Wing surface and color.
- 6) Tablet surface and color.

	Number	Laminate Grade A Fabric Grade								Leather Grade A	Leather Grade B			
		1	2	3	A	B	C	D	E			F	G	H
Leather	SHL-15-			1	N/A	N/A	N/A	N/A	N/A	N/A	N/A	N/A	\$6647.04	\$7115.88
Fabric	SHL-25-			1	\$4745.10	\$4865.40	\$4991.05	\$5120.17	\$5313.05	\$5514.72	\$5725.28	\$5948.20	N/A	N/A
Faux Leather	SHL-35-			1	\$4745.10	\$4865.40	\$4991.05	\$5120.17	\$5313.05	\$5514.72	\$5725.28	\$5948.20	N/A	N/A

	Number	Wood Fabric Grade								Leather Grade A	Leather Grade B			
		1	2	3	A	B	C	D	E			F	G	H
Leather	SHL-14-			1	N/A	N/A	N/A	N/A	N/A	N/A	N/A	N/A	\$6721.35	\$7190.19
Fabric	SHL-24-			1	\$4819.41	\$4939.71	\$5065.36	\$5194.48	\$5387.36	\$5589.03	\$5799.59	\$6022.51	N/A	N/A
Faux Leather	SHL-34-			1	\$4819.41	\$4939.71	\$5065.36	\$5194.48	\$5387.36	\$5589.03	\$5799.59	\$6022.51	N/A	N/A

# Harbor Work Lounge

Partially Upholstered, Cast Aluminum Base

**Ottoman**



SHO-25-G

**Dimensions**

H: 16.25"-19.25"  
(413mm-489mm)  
D: 17.9" (455mm)  
W: 24.9" (632mm)

**Features**

- Includes: Laminate or wood veneer surface, fabric cushion, cup holder and cast aluminum base.
- Upholstered one-piece molded plywood.
- Cushion: Upholstered molded foam 1"(25.4mm) thick with exposed laminate or wood veneer perimeter.
- Cast Aluminum Base: Features 3.0"(76.2mm) height adjustment.
  - Standard painted in Black, Accent Orange, Smooth Plaster or with optional polished aluminum.
- Cup holder: Swing out open hole cup holder standard in polished aluminum.
- Casters: Available with hard black, soft black or hard two-tone.
- Glides: Optional glides ship with plastic and felt tips.
- COM Yardage / COL square footage: 1.0/10

**To Order, Specify:**

- 1) Product number, including:
  - 1** Base Option:
    - 1** Hard Caster
    - 2** Soft Caster, add **\$66.08** list
    - T** Two-Tone
    - G** Glides, add **\$256.54** list
- 2) Inner surface material.
- 3) Outer surface material.
- 4) Base color  
Polished aluminum, add **\$132.69** list.

	Number ①	Laminate Grade A Fabric Grade								Leather Grade A	Leather Grade B
		A	B	C	D	E	F	G	H		
Leather	SHO-15-	N/A	N/A	N/A	N/A	N/A	N/A	N/A	N/A	\$3933.01	\$4237.32
Fabric	SHO-25-	\$2691.01	\$2770.61	\$2852.01	\$2936.96	\$3062.56	\$3193.47	\$3331.47	\$3476.53	N/A	N/A
Faux Leather	SHO-35-	\$2691.01	\$2770.61	\$2852.01	\$2936.96	\$3062.56	\$3193.47	\$3331.47	\$3476.53	N/A	N/A

	Number ①	Wood Fabric Grade								Leather Grade A	Leather Grade B
		A	B	C	D	E	F	G	H		
Leather	SHO-14-	N/A	N/A	N/A	N/A	N/A	N/A	N/A	N/A	\$3975.46	\$4279.77
Fabric	SHO-24-	\$2733.46	\$2813.06	\$2894.46	\$2979.41	\$3105.01	\$3235.92	\$3373.92	\$3518.98	N/A	N/A
Faux Leather	SHO-34-	\$2733.46	\$2813.06	\$2894.46	\$2979.41	\$3105.01	\$3235.92	\$3373.92	\$3518.98	N/A	N/A

# Hello Seating

Lounge with Legs

## Standard Arm

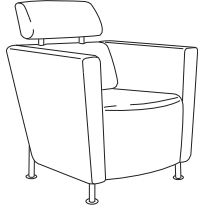

4854-0011

### Dimensions

SH: 17.5"(445mm)  
 H: 35"(889mm)  
 D: 30.25"(768mm)  
 W: 30.5"(775mm)  
 SD: 20.25"(514mm)  
 SW: 21.25"(540mm)  
 AH: 9.5"(241mm)

### Features

- Available as single cushion lounge chair.
- Upholstered back/seat.
- Passive lumbar back support.
- Interior frame has glued and doweled joints, reinforced with screws and cleats.
- Exposed metal legs.
- Optional two fabrics/one fabric two colors available on seat and back.
- Legs, back support uprights and optional grommets are available in TR-LE Metallic Silver only.
- COM yardage / COL square footage:  
 One Seat Lounge: 4.25/76.5  
 Seat: 1.0/18.0  
 Back and Arms: 3.25/58.7

### To Order, Specify:

- 1) Product number.
- 2) Fabric surface and color.  
 or 2a. Fabric surface and color for seat.  
 2b. Fabric surface and color for back and arms
- 3) Trim color for legs, back support uprights  
**(Available in TR-LE Metallic Silver Only)**

Description	Number	Fabric Grade		C	D	E	F	G	H	Leather Grade A	Leather Grade B
		A	B								
Lounge chair w/o grommets	4854-0011	\$3198.79	\$3472.06	\$3705.12	\$4223.54	\$4372.23	\$4587.18	\$4884.61	\$5706.39	\$ 8547.53	\$11496.18
Lounge chair with two fabrics/colors	4854-0011-T	\$3198.79	\$3745.33	\$4211.45	\$5248.29	\$5545.67	\$5975.57	\$6570.43	\$8213.99	\$13896.27	\$19793.57

The following options require modification of the product number.

Stain Repellent

To specify, add **-P** to the end of the product number; **Example:** 4854-0011-**P** (add **\$104.46** list)

Moisture Barrier with Stain Repellent

To specify, add **-D** to the end of the product number; **Example:** 4854-0011-**D** (add **\$164.75** list)

Leather Upholstery

To specify, change the 2nd digit in the product number from an **8** to a **7** and specify the leather surface and color;

**Example:** 4754-0011

**NOTE:** Stain repellent and moisture barrier are not available on leather or faux leather.

For available fabrics, refer to [surfaces.haworth.com](http://surfaces.haworth.com).

---

**Features and Options**
**Frame**

- Combination of hardwood rails, premium grade plywood and engineering grade oriented strand board
- The seat, back and arms use a box construction method. Each box is then fastened together using metal T-nuts.
- Optional back handle

**Cushioning**

- High-density foam
- Webbed seat and back

**Upholstery**

- One Fabric
- Two Fabrics (first fabric on seat, back and ottoman; second fabric on arm structures)
- Faux Leather
- Leather

**Base Options**

- Stationary
  - 2 metal legs front and rear
- Mobile
  - 2 twin-wheel casters front, 2 metal legs rear

---

**COM & COL General Information**

To order a COM fabric (Customer's Own Material), contact the Haworth Inquiry Center (1.800.426.8562), your local Haworth dealer, or go to [haworth.com/surfaces](http://haworth.com/surfaces) > COM Library to find out if the COM you have selected has already been tested and approved. The surface collection site also has information on the Haworth + alliance program with Carnegie, Luna Textiles, and Maharam as well as our industry-leading Pre-Approved COM program.

COM fabrics are placed into Grades based on the cost per linear yard. If a fabric's cost exceeds the range of our highest Grade it will be noted as Non-Graded. The product will be priced at Grade A; the COM fabric costs will appear as a separate line item. The fabric charge will be Haworth's purchase cost plus a 4% administrative fee (based on the cost of the fabric). Yardage calculations will include any applicable fabric repeat.

COM Leather products will be priced at a leather Grade A; COL costs will appear as a separate line item. The leather costs will be Haworth's purchase cost plus a 4% administrative fee (based on the cost of the leather).

# ToDo

## General Specifications

---

### Specification Guidelines

- When more than two fabrics or mixing materials such as fabric and faux leather are specified contact Haworth Tailored Solutions for pricing and lead time.

To insure order accuracy and acceptance, features and options must be specified in the following order (top-down):

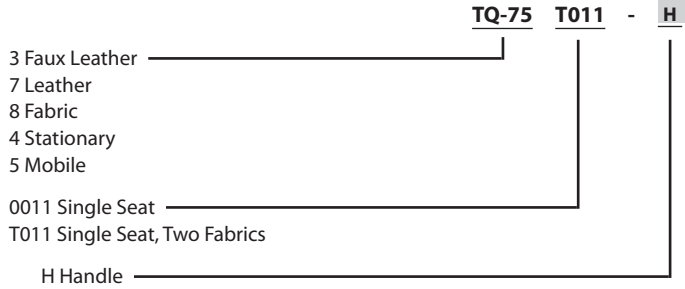

- ToDo Leather, Mobile, Single Seat with two fabrics, Handle



**ToDo**  
Single, Stationary

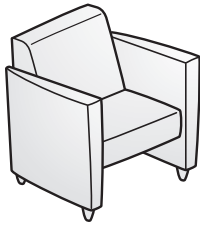

TQ84-0011

**Dimensions**

Overall:  
 H 31.25"(794mm)  
 D 29.25"(743mm)  
 W 30"(762mm)  
 Seat:  
 H 17.5"(445mm)  
 D 19"(483mm)  
 W 21.5"(546mm)  
 Arm:  
 H 24.125"(613mm)

**Features**

- Standard without grommets.
- COM yardage / COL square footage:  
 ToDo Single: 5.0/96.0  
 Seat and Back: 4.0/72.0  
 Arms Only: 3.0/54.0

**To Order, Specify:**

- 1) Product number.
- 2) Fabric or  
 a. Fabric for seat and back.  
 b. Fabric for arms.
- 3) Trim color for feet and handle.

**Specification Tips**

- For help in specifying multiple options, refer to page 272.
- When specifying mixed grade fabrics, list price will not exceed the highest grade fabric specified.

Description	Number	Fabric Grade		C	D	E	F	G	H	Leather Grade A	Leather Grade B
		A	B								
<b>One Fabric</b>											
Standard	TQ84-0011	\$3988.43	\$4116.97	\$4326.07	\$4466.67	\$4956.93	\$5619.97	\$5965.53	\$6934.05	\$6230.79	\$7471.23
With Handle	TQ84-0011-H	4115.02	4243.56	4452.66	4593.26	5083.52	5746.56	6092.12	7060.64	6357.38	7597.82
<b>Two Fabrics</b>											
Standard	TQ84-T011	\$4125.08	\$4253.62	\$4462.72	\$4603.32	\$5093.58	\$5756.62	\$6102.18	\$7070.70	\$6367.44	\$7607.88
With Handle	TQ84-T011-H	4251.67	4380.21	4589.31	4729.91	5220.17	5883.21	6228.77	7197.29	6494.03	7734.47

The following options require modification of the product number.

- |                                       |   |
|---------------------------------------|---|
| Faux Leather                          | To specify, change the 3rd digit from an 8 to a 3; <b>Example:</b> TQ34-0011  |
| Leather                               | To specify, change the 3rd digit from an 8 to a 7; <b>Example:</b> TQ74-0011  |
| Stain repellent                       | To specify, add <b>-P</b> to the end of the product number; <b>Example:</b> TQ84-0011- <b>P</b> (add \$104.46 list) |
| Moisture Barrier with Stain Repellent | To specify, add <b>-D</b> to the end of the product number; <b>Example:</b> TQ84-0011- <b>D</b> (add \$164.75 list) |
- For available fabrics, refer to [surfaces.haworth.com](http://surfaces.haworth.com).

# ToDo

Single, Mobile

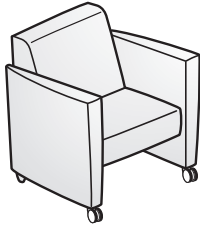

TQ85-0011

### Dimensions

Overall:

H	31.25"(794mm)
D	29.25"(743mm)
W	30"(762mm)

Seat:

H	17.5"(445mm)
D	19"(483mm)
W	21.5"(546mm)

Arm:

H	24.25"(613mm)
---	---------------

### Features

- Standard without grommets.
- COM yardage / COL square footage:  
ToDo Single: 5.0/96.0  
Seat and Back: 4.0/72.0  
Arms Only: 3.0/54.0

### To Order, Specify:

- 1) Product number.
- 2) Fabric or
  - a. Fabric for seat and back.
  - b. Fabric for arms.
- 3) Trim color for feet and handle.

### Specification Tips

- For help in specifying multiple options, refer to page 272.
- When specifying mixed grade fabrics, list price will not exceed the highest grade fabric specified.

Description	Number	Fabric Grade								Leather Grade A	Leather Grade B
		A	B	C	D	E	F	G	H		
<b>One Fabric</b>											
Standard	TQ85-0011	\$3988.43	\$4116.97	\$4332.03	\$4474.71	\$4956.93	\$5619.97	\$5973.61	\$6940.11	\$6232.85	\$7467.39
With Handle	TQ85-0011-H	4115.02	4243.56	4458.62	4601.30	5083.52	5746.56	6100.20	7066.70	6359.44	7593.98
<b>Two Fabrics</b>											
Standard	TQ85-T011	\$4125.08	\$4253.62	\$4468.68	\$4611.36	\$5093.58	\$5756.62	\$6110.26	\$7076.76	\$6369.50	\$7604.04
With Handle	TQ85-T011-H	4251.67	4380.21	4595.27	4737.95	5220.17	5883.21	6236.85	7203.35	6496.09	7730.63

The following options require modification of the product number.

Faux Leather	To specify, change the 3rd digit from an 8 to a 3; <b>Example:</b> TQ35-0011
Leather	To specify, change the 3rd digit from an 8 to a 7; <b>Example:</b> TQ75-0011
Stain repellent	To specify, add <b>-P</b> to the end of the product number; <b>Example:</b> TQ85-0011- <b>P</b> (add <b>\$104.46</b> list)
Moisture Barrier with Stain Repellent	To specify, add <b>-D</b> to the end of the product number; <b>Example:</b> TQ85-0011- <b>D</b> (add <b>\$164.75</b> list)
For available fabrics, refer to <a href="http://surfaces.haworth.com">surfaces.haworth.com</a> .	

**Tilt**  
Stool

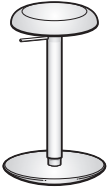
		<b>Number</b>	<b>Price</b>
 <p>STS-1</p>	<p><b>Dimensions</b></p> <p>SH: 23.5"-34.75" (597mm-883mm)</p> <p>Seat: 12"(305mm) Diameter</p> <p>Base: 14"(356mm) Diameter</p> <p>Col.: 2"(51mm) Diameter</p>	<p>STS-1</p> <p><b>Features</b></p> <ul style="list-style-type: none"> <li>• Base: Overmolded structural urethane covered with steel.</li> <li>• Base is rounded to allow movement and allow user to lean on stool.</li> <li>• Seat: Urethane with an MDF substrate.</li> <li>• Seat available in black only.</li> <li>• Steel column with pneumatic height adjustment.</li> <li>• Available in four trim colors. Black (TR-F), Graphite (TR-J), Accent Orange (TR-1E) or Smooth Plaster (TR-PLS).</li> </ul>	<p><b>To Order, Specify:</b></p> <ol style="list-style-type: none"> <li>1) Product number.</li> <li>2) Trim color.</li> </ol>
		<p><b>Specification Tips</b></p> <ul style="list-style-type: none"> <li>• Plant feet firmly on the floor while leaning on the seat.</li> <li>• Rounded base allows movement in any direction.</li> </ul>	

## Finish/Color Legends

### Fern

#### Trim Colors

TR-F	Black
TR-7	Fog
TR-UFM	Snow

#### Aluminum Colors

TR-MC	Metallic Champagne
TR-LE	Metallic Silver
TR-TF	Pitch
PM-P	Polished Aluminum

#### Knit

XQ-1	Baltic Blue
XQ-2	Coastal Grey
XQ-4	Nautical Orange
XQ-5	Ocean Basalt
XQ-6	Seaweed

#### Mesh

MB-BE	Beach
MB-CL	Coal
MB-CF	Cornflower
MB-MF	Moon Flower
MB-MU	Mulch
MB-MR	Mushroom
MB-PM	Peat Moss
MB-RR	River Rock
MB-SE	Sedum
MB-SL	Silver Leaf

### Harbor Work Lounge

#### Base

#### Trim Colors

TR-PLS	Smooth Plaster
TR-F	Black
TR-1E	Accent Orange
PM-P	Polished Aluminum

#### Cup Holder

#### Trim Colors

TR-AK	Chalk
TR-F	Black

#### Tablet Arms

#### Laminate

H-WL	Linen
H-AA	Putty
H-8J	Charcoal

#### Veneer

VR-W35	Clear on Walnut
NR-W35	Clear on Rift Cut White Oak

#### Noble Wing Material

JA-AR	Arctic	JA-FL	Flagstone
JA-BE	Bird's Egg	JA-FG	Fresh Green
JA-CA	Carbon	JA-LG	Light Gray
JA-CT	Citrus	JA-MA	Marinara
JA-CW	Cornwall	JA-GR	Oxford Gray
JA-EM	Ember	JA-PA	Pachyderm
JA-FA	Fawn		

### Hello Seating

#### Trim Colors

TR-LE	Metallic Silver
-------	-----------------

### Improv H.E. Chairs/Improv H.E. Stool

#### Trim Colors

TR-F	Black
TR-J	Graphite
TR-G	Gray Tone

**Note:** Improv H.E. Chairs with optional high arc base are available in TR-F (Black) trim only.

### Improv Series Leg-Base/Sled-Base Chairs and Stools

#### Trim Colors

TR-F	Black
TR-J	Graphite
TR-G	Gray Tone
TR-E	Smoke

#### Metallic Trim Colors

TR-MC	Champagne
TR-LE	Silver

#### Wood Finish Colors

#### Maple

M2-CA1	Amber
M2-W23	American
M2-W33	Carmel
M2-W15	Espresso
M2-W30	Heritage
M2-W07	Light Anegre
M2-N	Natural
M2-W32	Pacific
M2-W31	Retro
M2-AD	Sand

**Note:**

- Specifying a common stain color for casegoods, wood seating, and wood occasional tables will result in a suite of furniture which has a commercially acceptable finish match.
- Different wood species are offered on the various casegoods, chairs, and tables. Each species offer unique texture, grain, and color of raw wood and veneer. Minor variations in finish color and texture may occur due to these natural characteristics of wood. This is part of the natural beauty of wood and is not considered to be a defect.

**ALERT:** These materials are current, however they are being considered for future obsolescence due to low volume.

#### Wood Finish Colors

M2-W08	Golden Anegre
M2-W12	Naturally Walnut

### Maari

#### Shell / Arm Caps Polymer Colors

TR-1T	Balsam
TR-F	Black
TR-CF	Coffee
TR-G	Gray Tone
TR-1V	Indigo
TR-RR	Rusty Red
TR-PLS	Smooth Plaster
TR-1W	Water
TR-1K	Wren

#### Sled Base

#### Trim Colors

TR-F	Black
TR-LE	Metallic Silver
TR-RR	Rusty Red
TR-PLS	Smooth Plaster
TR-1K	Wren
KR-V	Chrome

#### Matte Trim Colors

TR-M1	Black Matte
TR-M2	Smooth Plaster Matte

#### Four-Leg

#### Trim Colors

TR-F	Black
TR-LE	Metallic Silver
TR-RR	Rusty Red
TR-PLS	Smooth Plaster
TR-1K	Wren

#### Matte Trim Colors

TR-M1	Black Matte
TR-M2	Smooth Plaster Matte

#### Wood-Leg Wood Finish

M5-W35	Clear on White Oak
M5-W43	Ink on Oak
M5-W44	Walnut on Oak

#### Four-Star and Five-Star Base

#### Trim Colors

TR-F	Black
TR-PLS	Smooth Plaster

#### Matte Trim Colors

TR-M1	Black Matte
TR-M2	Smooth Plaster Matte

#### Tablet Wood Finish

VH-W35	Plank Walnut
VB-W35	Plank White Oak

#### Painted MDF

PW-F	Black
PW-PL	Polar

#### Laminate

H-8J	Charcoal
H-KM	Landmark
H-WL	Linen
H-KL	Neo Walnut

# Finish/Color Legends

## Openest

### Trim Colors

TR-1E	Accent Orange
TR-F	Black
TR-PLS	Smooth Plaster
TR-RR	Rusty Red

### Thread Colors

NS-1E	Accent Orange
NS-F	Black
NS-PLS	Plaster
NS-RR	Rusty Red
NS-SN	Sand

### Table Surfaces - Painted

PW-F	Black
PW-PL	Polar
PW-SY	Stormy
PW-VA	Vapor

### Sprig Table Surfaces - Wood

VB-W35	Plank White Oak
VH-W35	Plank Walnut

## Pip

### Trim

#### Grade A Smooth

TR-R	Beige
TR-AK	Chalk
TR-K	Charcoal
TR-C1	Cocoa
TR-J	Graphite
TR-G	Gray Tone
TR-AA	Putty
TR-E	Smoke
TR-PLS	Smooth Plaster
TR-FM	Snow

#### Grade B Smooth

TR-1C	Accent Blue
TR-1F	Accent Red
TR-1G	Blue Jay
TR-1R	Brownstone
TR-1N	Night
TR-1Q	Park
TR-RR	Rusty Red
TR-1M	Sable
TR-1J	Sky Blue

#### Grade B Smooth Metallic

TR-MC	Metallic Champagne
TR-LE	Metallic Silver

#### Textured Metallic

TR-AR	Argent
TR-HE	Hellenic

**ALERT:** These materials are current, however they are being considered for future obsolescence due to low volume.

### Surface - Painted MDF

#### Grade A

PW-R	Beige
PW-F	Black
PW-AK	Chalk
PW-G	Gray Tone
PW-PL	Polar
PW-SY	Stormy
PW-VA	Vapor

#### Grade B

PW-RR	Rusty Red
PW-1J	Sky Blue
PW-SP	Sparrow
PW-ST	Straw
PW-1H	Terra

### Surface - Wood

VB-W35	Plank White Oak
VH-W35	Plank Walnut

### Textured

TR-TG	Grout
TR-TF	Pitch
TR-TW	Plaster

#### Trim Colors

TR-1E	Accent Orange
TR-CTS	Chartreuse
TR-DM	Dark Bronze Metallic
TR-1H	Terra
TR-1K	Wren

## Poppy

### Guest

#### Trim Colors

TR-F	Black
TR-PLS	Smooth Plaster

### Lounge

#### Trim Colors

TR-F	Black
TR-1M	Sable
TR-RR	Rusty Red
TR-PLS	Smooth Plaster

### Wood Finishes

M5-W35	Clear on Oak
M6-W35	Clear on Walnut
M7-W43	Ink on Ash

### Tablet

#### Wood

VH-W35	Plank Walnut
VB-W35	Plank White Oak

### Painted MDF

PW-F	Black
PW-PL	Vapor

### Laminate

H-8J	Charcoal
H-KM	Landmark
H-WL	Linen
H-KL	Neo Walnut

## Riverbend

### Trim Colors

TR-TF	Pitch (textured)
TR-TW	Plaster (textured)

**ALERT:** These materials are current, however they are being considered for future obsolescence due to low volume.

#### Trim Colors

TR-AR	Argent
-------	--------

## Soji

### Trim Colors

TR-F	Black
TR-7	Fog
TR-UFM	Snow

### Knit

XT-1	Carbon
XT-2	Cayenne
XT-3	Clay
XT-4	Juniper
XT-5	Mist
XT-6	Navy
XT-7	Ocean
XT-9	Steel
XT-10	Stone

## ToDo Seating

### Trim Colors

TR-F	Black
TR-M01	Switch Silver

### Maple Veneer Finish

M2-CA1	Amber
M2-W23	American
M2-W33	Carmel
M2-W15	Espresso
M2-W30	Heritage
M2-W07	Light Anegre
M2-W21	Mahogany Satin
M2-N	Natural
M2-W32	Pacific
M2-W31	Retro
M2-AD	Sand

**ALERT:** These materials are current, however they are being considered for future obsolescence due to low volume.

#### Maple Veneer Finish

M2-W08	Golden Anegre
M2-W12	Naturally Walnut

## Finish/Color Legends

### Very Side

#### Polymer Colors

TR-F	Black
TR-FL	Canvas
TR-FK	Cocoa
TR-CF	Coffee (Perf. Back and Wire Stacker only)
TR-7	Fog
TR-HR	Heron (Perf. Back and Wire Stacker only)
TR-KL	Kale (Perf. Back and Wire Stacker only)
TR-FJ	Slate
TR-FM	Snow
TR-FA	Tomato

#### Trim Color

TR-F	Black
TR-7	Fog

#### Base Colors - Painted

TR-F	Black
TR-MC	Metallic Champagne
TR-LE	Metallic Silver
PM-P	Polished Aluminum (conference chair only)
KR-V	Trivalent Chrome (wire stacker, side and seminar)

#### Base Colors - Plastic (conference chair only)

TR-F	Black
TR-7	Fog

### Very Task

#### Plastic Trim Color

TR-F	Black
TR-7	Fog
TR-UFM	Snow*

#### Plastic Base

TR-F	Black
TR-7	Fog

#### Aluminum Base

PM-P	Polished Aluminum
TR-F	Black
TR-MC	Metallic Champagne
TR-LE	Metallic Silver

#### Aluminum Frame Colors

TR-F	Black
TR-MC	Metallic Champagne
TR-LE	Metallic Silver
TR-FS	Snowfall
PM-P	Polished Aluminum

#### Knit

XY-1	Cinnamon
XY-2	Jasper
XY-3	Jute
XY-4	Sea Glass
XY-5	Shale

#### Mesh

MS-F	Black
MS-FK	Cocoa
MS-7	Fog
MS-HR	Heron
MS-KL	Kale
MS-FJ	Slate
MS-FM	Snow

\*Arm caps and adjustable levers default to Fog.

### X99

#### Trim Colors

TR-F	Black
KR-V	Chrome*

#### Metallic Trim Colors

TR-LE	Silver
-------	--------

#### Mesh

MO-BL	Black
-------	-------

\*Refer to price pages for chrome specification information and upcharge.

### Zody

#### Aluminum Base and Arm Uprights

##### Paint Colors

TR-F	Black
TR-LE	Metallic Silver
TR-MC	Metallic Champagne
PM-P	Polished Aluminum
KR-V	Trivalent Chrome*

##### Trim Color

TR-F	Black
TR-E	Smoke
TR-UFM	Snow

##### Wood Back Finish Color

VT-W04	Beech
--------	-------

##### Plastic Base

TR-F	Black
------	-------

##### Knit

X4-2	Emerald
X4-3	Moonstone
X4-1	Onyx
X4-4	Rosewood
X4-5	Topaz

##### Mesh

MA-9	Calm
MA-2	Comfort
MA-5	Gusto
MA-10	Hush
MA-4	Relax
MA-1	Support
MA-12	Tranquil
MA-3	Wellness
MA-13	Zen

\*Trivalent chrome available on Zody guest chair only. Refer to price pages for specification information and upcharge.

### Zody II and Zody LX

#### Aluminum Base and Arm Uprights

##### Paint Colors

TR-MC	Metallic Champagne
TR-LE	Metallic Silver
TR-UFS	Snow Fall
PM-P	Polished Aluminum

##### Trim Color

TR-F	Black
TR-7	Fog
TR-UFM	Snow

##### Plastic Base

TR-F	Black
TR-7	Fog

##### Zody II Knit

X4-2	Emerald
X4-3	Moonstone
X4-1	Onyx
X4-4	Rosewood
X4-5	Topaz

##### Zody II Mesh

MA2-4	Balsam
MA2-5	Bark
MA2-2	Comfort
MA2-6	Engine
MA2-7	Fog
MA2-8	Navy
MA2-1	Support
MA2-9	Water
MA2-3	Wellness

## Finish/Color Legends

Wood Seating	Wood Seating		
	Composites	Hello	ToDo
<p>The following matrix shows the standard finish offering for each seating product line.</p> <p>Because of the natural properties of wood, variations of grain pattern and finish color can be expected. Haworth carefully selects materials used in the manufacturing of products to promote consistent and acceptable color. Wood is susceptible to color change from exposure to UV rays. Haworth finishes include a UV stabilizer to reduce these effects.</p> <p>Natural finish on Maple is a clear coat only and will show all the characteristics of the wood.</p>			
<b>Maple</b>			
Amber (M2-CA1)*	●	●	●
American (M2-W23)	●	●	●
Caramel (M2-W33)	●	●	●
Espresso (M2-W15)*	●	●	●
Heritage (M2-W30)	●	●	●
Light Anegre (M2-W07)	●	●	●
Natural (M2-N)	●	●	●
Pacific (M2-W32)	●	●	●
Retro (M2-W31)*	●	●	●
Sand (M2-AD)*	●	●	●

\*Compatible wood finish color will complement wood casegoods finish color, not necessarily wood species characteristics.

Wood Seating	Wood Seating
	Candor
<p>Because of the natural properties of wood, variations of grain pattern and finish color can be expected. Haworth carefully selects materials used in the manufacturing of products to promote consistent and acceptable color. Wood is susceptible to color change from exposure to UV rays. Haworth finishes include a UV stabilizer to reduce these effects.</p>	
<b>Beech</b>	
Amber (M3-CA1)	●
American (M3-W23)	●
Caramel (M3-W33)	●
Ebony (M3-RE)	●
Espresso (M3-W15)	●
Heritage (M3-W30)	●
Light Anegre (M3-W07)	●
Natural (M3-W04)	●
Pacific (M3-W32)	●
Retro (M3-W31)	●
Sand (M3-AD)	●
Sorrel (M3-RC)	●
Wenge (M3-RW)	●

\*Compatible wood finish color will complement wood casegoods finish color, not necessarily wood species characteristics.

**ALERT:** These materials are current, however they are being considered for future obsolescence due to low volume.

Maple	
Golden Anegre	M2-W08
Naturally Walnut	M2-W12

Beech	
Golden Anegre	M3-W08
Natural Walnut	M3-W12

# Fabric Pattern Usage

Haworth seating models are restricted to fabric patterns that meet applicability standards for tailoring. A dot in the matrix below indicates fabric acceptability on seating series or specific models listed. Fabrics are listed alphabetically by grades.

Grade: Pattern (Surface Code)	Series/ Model																			
	Fern	Harbor Work Lounge	Hello	Improv H.E.	Improv Leg-Base/Sled-Base Stool - Upholstered Back	Improv Leg-Base/Sled-Base Stool - Plastic Back	Maari	Openest	Openest Pillows	Pebble	Poppy	Riverbend	Soji	ToDo	Very/Very Task	X99	Zody	Zody II, Zody LX	Wood (Candor)	Wood (All Other Models)
<b>Haworth Fabrics</b>																				
A: Blanket (4H)	•	•	•	•	•	•	•	•	•	•	•	•	•	•	•	•	•	•	•	•
A: Hobson (3J)	•	•	•	•	•	•	•	•	•	•	•	•	•	•	•	•	•	•	•	•
A: Morse (4J)	•	•	•	•	•	•	•	•	•	•	•	•	•	•	•	•	•	•	•	•
A: Novelty (3L)	•	•	•	•	•	•	•	•	•	•	•	•	•	•	•	•	•	•	•	•
A: Pixel (2A)	•	•	•	•	•	•	•	•	•	•	•	•	•	•	•	•	•	•	•	•
A: Tellure (3A)	•	•	•	•	•	•	•	•	•	•	•	•	•	•	•	•	•	•	•	•
A: Twist (MM)	•	•	•	•	•	•	•	•	•	•	•	•	•	•	•	•	•	•	•	•
A: Wellington Faux Leather (XJ)	•	•	•	•	•	•	•	•	•	•	•	•	•	•	•	•	•	•	•	•
B: Diagonale (4N)	•	•	•	•	•	•	•	•	•	•	•	•	•	•	•	•	•	•	•	•
B: Element (4Z)	•	•	•	•	•	•	•	•	•	•	•	•	•	•	•	•	•	•	•	•
B: English Tweed (4E)	•	•	•	•	•	•	•	•	•	•	•	•	•	•	•	•	•	•	•	•
B: Floyd by Kvadrat (S6)	•	•	•	•	•	•	•	•	•	•	•	•	•	•	•	•	•	•	•	•
B: Gauge (1X)	•	•	•	•	•	•	•	•	•	•	•	•	•	•	•	•	•	•	•	•
B: Kaleidoscope (S4)	•	•	•	•	•	•	•	•	•	•	•	•	•	•	•	•	•	•	•	•
B: Pemberton (SN)	•	•	•	•	•	•	•	•	•	•	•	•	•	•	•	•	•	•	•	•
B: Ramie (4V)	•	•	•	•	•	•	•	•	•	•	•	•	•	•	•	•	•	•	•	•
B: Reflect by Kvadrat (S8)	•	•	•	•	•	•	•	•	•	•	•	•	•	•	•	•	•	•	•	•
B: Squares (RA)	•	•	•	•	•	•	•	•	•	•	•	•	•	•	•	•	•	•	•	•
B: Tech (MV)	•	•	•	•	•	•	•	•	•	•	•	•	•	•	•	•	•	•	•	•
C: Dots (6K)	•	•	•	•	•	•	•	•	•	•	•	•	•	•	•	•	•	•	•	•
C: King II (67)	•	•	•	•	•	•	•	•	•	•	•	•	•	•	•	•	•	•	•	•
C: Maya II (68)	•	•	•	•	•	•	•	•	•	•	•	•	•	•	•	•	•	•	•	•
C: Oceanic (4T)	•	•	•	•	•	•	•	•	•	•	•	•	•	•	•	•	•	•	•	•
C: Scapes (3S)	•	•	•	•	•	•	•	•	•	•	•	•	•	•	•	•	•	•	•	•
D: Atlas by Kvadrat (LW)	•	•	•	•	•	•	•	•	•	•	•	•	•	•	•	•	•	•	•	•
D: Big Arrow (4D)	•	•	•	•	•	•	•	•	•	•	•	•	•	•	•	•	•	•	•	•
D: Big Diagonale (1K)	•	•	•	•	•	•	•	•	•	•	•	•	•	•	•	•	•	•	•	•
D: Clara 2 by Kvadrat (NV)	•	•	•	•	•	•	•	•	•	•	•	•	•	•	•	•	•	•	•	•
D: Class II (66)	•	•	•	•	•	•	•	•	•	•	•	•	•	•	•	•	•	•	•	•
D: Cotswold (JB)	•	•	•	•	•	•	•	•	•	•	•	•	•	•	•	•	•	•	•	•
D: Main Line Flax (6M)	•	•	•	•	•	•	•	•	•	•	•	•	•	•	•	•	•	•	•	•
D: Melange Nap by Kvadrat (S7)	•	•	•	•	•	•	•	•	•	•	•	•	•	•	•	•	•	•	•	•
D: Recheck by Kvadrat (RP)	•	•	•	•	•	•	•	•	•	•	•	•	•	•	•	•	•	•	•	•
D: Tangram (LV)	•	•	•	•	•	•	•	•	•	•	•	•	•	•	•	•	•	•	•	•
E: Brisa Faux Leather (XG)	•	•	•	•	•	•	•	•	•	•	•	•	•	•	•	•	•	•	•	•
E: Steelcut Trio by Kvadrat (SY)	•	•	•	•	•	•	•	•	•	•	•	•	•	•	•	•	•	•	•	•
F: Divina Melange 3 by Kvadrat (SV)	•	•	•	•	•	•	•	•	•	•	•	•	•	•	•	•	•	•	•	•
F: Hallingdal 65 by Kvadrat (SZ)	•	•	•	•	•	•	•	•	•	•	•	•	•	•	•	•	•	•	•	•
<b>Leathers</b>																				
A: Plains Leather (XP)	•	•	•	•	•	•	•	•	•	•	•	•	•	•	•	•	•	•	•	•
B: Nature Leather (XE)	•	•	•	•	•	•	•	•	•	•	•	•	•	•	•	•	•	•	•	•

\*For most current finish and fabric availability please reference [surfaces.haworth.com](https://surfaces.haworth.com).

**ALERT:** These materials are current, however they are being considered for future obsolescence due to low volume.

<b>Grade A</b> Twist (MM)	<b>Grade B</b> Tech (MV) Gauge (1X)	<b>Grade D</b> Tangram (LV)
------------------------------	---	--------------------------------



# Haworth Fabrics/Color Legend

## Haworth+

For information on the Haworth+ alliance program, including images and product availability, please refer to:  
[Haworth.com > Surface Collection > Haworth+ Library](#)

## Customer's Own Material (COM)

For general Customer's Own Material (COM) information including processes and forms, please refer to:  
[Haworth.com > Surface Collection > Resources > COM](#)

For information on approved COM's, please refer to:  
[Haworth.com > Surface Collection > COM Library](#)

## Seating COM Pattern Repeat Information

Haworth will calculate and order COM yardage as needed for seating; however, for bid/quote purposes, please refer to the COM yardage requirements listed by each chair model. These numbers are based on solid or very small scale (under 1" repeat) fabrics.

For fabrics with repeats listed below, additional yardage should be included in your calculations. The additional yardage allows for matching of patterns on the seating.

REPEAT SIZE	ADD ADDITIONAL YARDAGE TO YOUR CALCULATIONS
1"-4"	Add 5%
5"-7"	Add 10%
8"-14"	Add 20%
15"-19"	Add 25%
20"-27"	Add 30%
28"-36"	Add 50%

# COM Yardage Requirements

**Procedure** To determine if a COM fabric has been approved for use on Haworth product, contact the Haworth Inquiry Center (1.800.426.8562), your local Haworth dealer, or go to [Haworth.com/surfaces](http://Haworth.com/surfaces) > COM Library. Haworth will calculate and order fabric unless instructed otherwise. If the dealer is to provide the fabric, they will calculate the yardage needed themselves.

If the fabric is approved, and the directional orientation (directional rightway, directional railroad, or non-directional) of the tested fabric has been confirmed, then refer to the appropriate price page for yardage requirements.

**COM Fabric Requirements**

The fabric yardage requirements for COMs given for each model are in lineal yards and are based on 54”(1372mm) usable fabric widths. Approximate yardage requirements are shown for each model within the price pages.

For fabrics already approved, with a COM order entry code assigned, Haworth will determine and purchase the yardage needed. If the fabric will be provided by the dealer, and the pattern has a large repeat or stripes, additional yardage will be needed; see the COM Yardage Requirements at the end of this price guide OR contact the COM Department for more information.

**COL Leather Requirements**

The leather requirements for COL (Customer’s Own Leather) will vary depending on the hide size and are based on square footage. Haworth will determine and purchase the leather needed.

Find total number of linear yards required for the order. Add the appropriate percentage shown below to the total yardage to accommodate fabric flaws, wrinkles and other imperfections.

Up to 500 yards	Add 10%
501 to 1000 yards	Add 5%
More than 1000 yards	Add 3%

**Directional Rightway:**

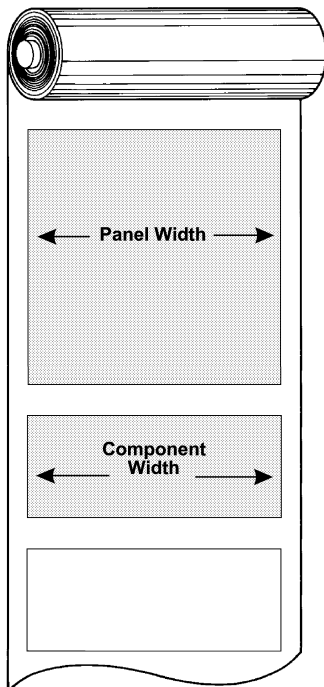
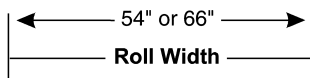

**Directional Railroad:**

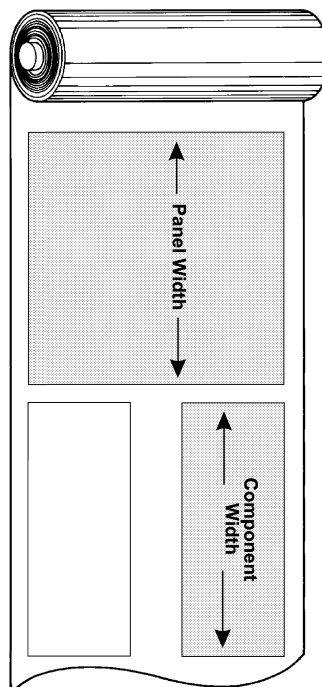
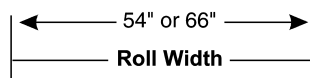

**Non-Directional:**

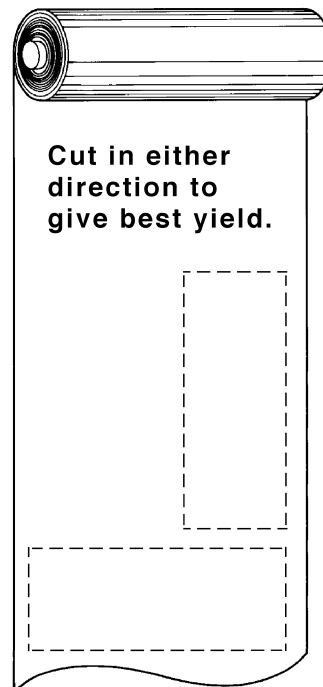
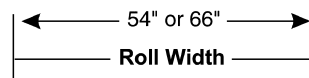

## Index

Products are listed alphabetically in this index by alpha-numeric prefix/suffix codes.

<b>Product Code</b>	<b>Product Description</b>	<b>Page</b>
4045-00	Composites Seating Series – Arc Arm, Upholstered Back	235
4049-00	Composites Seating Series – Stool, Armless, Upholstered Back	235
4854-0011	Hello Seating – Standard Arm	270
EUSM-HF0W-1100	Power Module – Hardwire	252
EUSM-HF0W-2100	Power Module – Hardwire	252
EUSM-HL0W-1100	Power Module – Hardwire	252
EUSM-HL0W-2100	Power Module – Hardwire	252
EUSM-PF0W-1100	Riverbend Power Module – Corded	252
EUSM-PF0W-2100	Riverbend Power Module – Corded	252
EUSM-PL0W-1100	Riverbend Power Module – Corded	252
EUSM-PL0W-2100	Riverbend Power Module – Corded	252
M231-1042	Improv Series – Without Arms	194
M231-1442	Improv Series – With Task Arms	191
M231-1H42	Improv Series – With Flipper Arms	192
M231-1W42	Improv Series – With Height and Width Adjustable 3-D Arms	193
M251-1042	Improv Series – Without Arms	190
M251-1442	Improv Series – With Task Arms	187
M251-1H42	Improv Series – With Flipper Arms	188
M251-1W42	Improv Series – With Height and Width Adjustable 3-D Arms	189
M271-1042	Improv Series – Without Arms	186
M271-1442	Improv Series – With Task Arms	184
M271-1H42	Improv Series – With Flipper Arms	185
M2E1-1042	Improv Series – Without Arms	198
M2E1-1442	Improv Series – With Task Arms	195
M2E1-1H42	Improv Series – With Flipper Arms	196
M2E1-1W42	Improv Series – With Height and Width Adjustable 3-D Arms	197
M600-2100	Improv Series – Without Arms	200
M600-2110	Improv Series – With Arms	199
M600-2300	Improv Series – Without Arms	200
M600-2310	Improv Series – With Arms	199
M600-8100	Improv Series – Without Arms	203
M600-8110	Improv Series – With Arms	203
M600-8300	Improv Series – Without Arms	203
M600-8310	Improv Series – With Arms	203
M601-2100	Improv Series – Without Arms, Non-Stacking	202
M601-2110	Improv Series – With Arms, Non-Stacking	201
M601-2300	Improv Series – Without Arms, Non-Stacking	202
M601-2310	Improv Series – With Arms, Non-Stacking	201
MPRV-BARS	Improv Series – Chair-to-Chair Connecting Bars	204
MPRV-CART	Improv Series – Stacking Dolly	204
S2TC-20-0	Zody II – Task Chair	46
S2TC-20-1	Zody II – Task Chair	46
S2TC-20-4	Zody II – Task Chair	46
S2TC-20-7	Zody II – Task Chair	46
S2TD-20-1	Zody II – Dual Posture	51
S2TD-20-4	Zody II – Dual Posture	51
S2TD-20-7	Zody II – Dual Posture	51

# Index

<b>Product Code</b>	<b>Product Description</b>	<b>Page</b>
S2TS-20-0	Zody II – Stool	.49
S2TS-20-1	Zody II – Stool	.49
S2TS-20-4	Zody II – Stool	.49
S2TS-20-7	Zody II – Stool	.49
S2UC-22-0	Zody LX – Task Chair without Arms	.59
S2UC-22-1	Zody LX – Task Chair with Fixed Arms	.59
S2UC-22-4	Zody LX – Task Chair with Height Adjustable Arms	.59
S2UC-22-7	Zody LX – Task Chair with 4D Arms	.59
S2UD-22-1	Zody LX – Dual Posture with Fixed Arms	.63
S2UD-22-4	Zody LX – Dual Posture with Height Adjustable Arms	.63
S2UD-22-7	Zody LX – Dual Posture with 4D Arms	.63
S2US-22-0	Zody LX – Stool without Arms	.61
S2US-22-1	Zody LX – Stool with Fixed Arms	.61
S2US-22-4	Zody LX – Stool with Height Adjustable Arms	.61
S2US-22-7	Zody LX – Stool with 4D Arms	.61
S74-22-0H	Maari – Without Arms	.223
S74-22-1H	Maari – With Arms	.222
S74-24-0H	Maari – Without Arms	.223
S74-24-1H	Maari – With Arms	.222
S74-44-0H	Maari – Without Arms	.223
S74-44-1H	Maari – With Arms	.222
S75-22-01	Maari – Without Arms	.225
S75-22-11	Maari – With Arms	.224
S75-24-01	Maari – Without Arms	.225
S75-24-11	Maari – With Arms	.224
S75-44-01	Maari – Without Arms	.225
S75-44-11	Maari – With Arms	.224
S7H-22-0H	Maari – Without Arms	.218
S7H-22-1H	Maari – With Arms	.217
S7H-24-0H	Maari – Without Arms	.218
S7H-24-1H	Maari – With Arms	.217
S7H-44-0H	Maari – Without Arms	.218
S7H-44-1H	Maari – With Arms	.217
S7HB-22-0H	Maari – Standard Back	.226
S7HB-24-0H	Maari – Standard Back	.226
S7HB-44-0H	Maari – Standard Back	.226
S7HC-22-0H	Maari – Standard Back	.226
S7HC-24-0H	Maari – Standard Back	.226
S7HC-44-0H	Maari – Standard Back	.226
S7S-22-0H	Maari – Without Arms	.220
S7S-22-11	Maari – With Arms	.219
S7S-24-0H	Maari – Without Arms	.220
S7S-24-11	Maari – With Arms	.219
S7S-44-0H	Maari – Without Arms	.220
S7S-44-11	Maari – With Arms	.219
S7SB-22-0H	Maari – Without Arms	.229
S7SB-22-1H	Maari – With Arms	.228
S7SB-24-0H	Maari – Without Arms	.229
S7SB-24-1H	Maari – With Arms	.228

## Index

<b>Product Code</b>	<b>Product Description</b>	<b>Page</b>
S7SB-44-0H	Maari – Without Arms	229
S7SB-44-1H	Maari – With Arms	228
S7SC-22-0H	Maari – Without Arms	229
S7SC-22-1H	Maari – With Arms	228
S7SC-24-0H	Maari – Without Arms	229
S7SC-24-1H	Maari – With Arms	228
S7SC-44-0H	Maari – Without Arms	229
S7SC-44-1H	Maari – With Arms	228
S7W-22-0H	Maari – Without Arms	221
S7W-24-0H	Maari – Without Arms	221
S7W-44-0H	Maari – Without Arms	221
S7WB-22-0H	Maari – Standard Back	230
S7WB-24-0H	Maari – Standard Back	230
S7WB-44-0H	Maari – Standard Back	230
S7WC-22-0H	Maari – Standard Back	230
S7WC-24-0H	Maari – Standard Back	230
S7WC-44-0H	Maari – Standard Back	230
S8HB-24-0H	Maari – Low Back	227
S8HC-24-0H	Maari – Low Back	227
S8WB-24-0H	Maari – Low Back	231
S8WC-24-0H	Maari – Low Back	231
SAS-22-A1A	Candor Modern Seating – Fully Upholstered Seat and Back	234
SAS-22-A3A	Candor Modern Seating – Fully Upholstered Seat and 1/2 Back	234
SCB-44-0H	Very – Seminar With Storage Rack	145
SCB-44-3H	Very – Seminar With Storage Rack	145
SCC-44-01	Very – Without Arms	149
SCC-44-11	Very – With Arms	148
SCF-44-01	Very – Without Arms	150
SCF-44-11	Very – Without Arms	150
SCH-44-0S	Very – Without Arms	133
SCH-44-3S	Very – With Arms	132
SCK-44-3H	Very – Side Chair With Tablet Arm	140
SCL-44-0H	Very – Side Chair With Tablet Arm	141
SCL-44-3H	Very – Side Chair With Tablet Arm	141
SCLC-44-0H	Very – Side Chair With Tablet Arm	142
SCLC-44-3H	Very – Side Chair With Tablet Arm	142
SCM-44-0H	Very – Without Arms	144
SCM-44-3H	Very – With Arms	143
SCS-44-0H	Very – Without Arms	138
SCS-44-3H	Very – With Arms	137
SCS-44-RH	Very – Side Chair With Tablet Arm	139
SCSG-1	Very – Ganging Connector	151
SCSG-2	Very – Ganging Connector	151
SCT-1	Very – Stacking Carts	151
SCT-20-0011	Very Task – Task Chair without Arms	120
SCT-20-1011	Very Task – Task Chair with Fixed Arms	118
SCT-20-4011	Very Task – Task Chair with Height Adjustable Arms	116
SCT-20-7011	Very Task – Task Chair with 4D Arms	114
SCT-3	Very – Stacking Carts	151

## Index

<b>Product Code</b>	<b>Product Description</b>	<b>Page</b>
SCT-4	Very – Stacking Carts	151
SCTC-20-0011	Very Task – Task Stool without Arms	128
SCTC-20-1011	Very Task – Task Stool with Fixed Arms	126
SCTC-20-4011	Very Task – Task Stool with Height Adjustable Arms	124
SCTC-20-7011	Very Task – Task Stool with 4D Arms	122
SCW-44-0S	Very – Bar Height Wire Stool	134
SCW-44-3S	Very – Bar Height Wire Stool	134
SCWC-44-0S	Very – Counter Height Wire Stool	135
SCWC-44-3S	Very – Counter Height Wire Stool	135
SE3S	Veda – Synchronized Tilt	177
SE3T	Veda – Standard Tilt	177
SE5S	Veda – Synchronized Tilt	178
SFS-U0-0N01A	Fern – Task Stool without Arms — Aluminum Base Model	38
SFS-U0-0N01A	Fern – Task Stool without Arms — Plastic Base Model	37
SFS-U0-1S01A	Fern – Task Stool with Fixed Arms — Aluminum Base Model	36
SFS-U0-1S01A	Fern – Task Stool with Fixed Arms — Plastic Base Model	35
SFS-U0-4S01A	Fern – Task Stool with Height Adjustable Arms — Aluminum Base Model	34
SFS-U0-4S01A	Fern – Task Stool with Height Adjustable Arms — Plastic Base Model	33
SFS-U0-7S01A	Fern – Task Stool with 4D Arms — Aluminum Base Model	32
SFS-U0-7S01A	Fern – Task Stool with 4D Arms — Plastic Base Model	31
SFT-U0-0N01A	Fern – Task Chair without Arms — Aluminum Base Model	30
SFT-U0-0N01A	Fern – Task Chair without Arms — Plastic Base Model	29
SFT-U0-1S01A	Fern – Task Chair with Fixed Arms — Aluminum Base Model	28
SFT-U0-1S01A	Fern – Task Chair with Fixed Arms — Plastic Base Model	27
SFT-U0-4S01A	Fern – Task Chair with Height Adjustable Arms — Aluminum Base Model	26
SFT-U0-4S01A	Fern – Task Chair with Height Adjustable Arms — Plastic Base Model	25
SFT-U0-7S01A	Fern – Task Chair with 4D Arms — Aluminum Base Model	24
SFT-U0-7S01A	Fern – Task Chair with 4D Arms — Plastic Base Model	23
SHL-22-1R10	Harbor Work Lounge – Lounge Chair	266
SHL-22-1R12	Harbor Work Lounge – Lounge Chair	266
SHL-25-1L10	Harbor Work Lounge – Lounge Chair	268
SHL-25-1L12	Harbor Work Lounge – Lounge Chair	268
SHO-22-G	Harbor Work Lounge – Ottoman	267
SHO-25-G	Harbor Work Lounge – Ottoman	269
SJT-20-011A	Soji – Task Chair without Arms — Aluminum Base	166
SJT-20-011A	Soji – Task Chair without Arms — Plastic Base	165
SJT-20-111A	Soji – Task Chair with Fixed Arms — Aluminum Base	164
SJT-20-111A	Soji – Task Chair with Fixed Arms — Plastic Base	163
SJT-20-401X	Soji – Task Chair with Height Adjustable Arms — Plastic Base	161
SJT-20-411X	Soji – Task Chair with Height Adjustable Arms — Aluminum Base	162
SJT-20-711A	Soji – Task Chair with 4D Arms — Aluminum Base	160
SJT-20-711A	Soji – Task Chair with 4D Arms — Plastic Base	159
SJTC-001A	Soji – Task Stool without Arms — Aluminum Base	174
SJTC-001A	Soji – Task Stool without Arms — Plastic Base	173
SJTC-001X	Soji – Task Stool without Arms — Aluminum Base	174
SJTC-001X	Soji – Task Stool without Arms — Plastic Base	173
SJTC-101A	Soji – Task Stool with Fixed Arms — Aluminum Base	172
SJTC-101A	Soji – Task Stool with Fixed Arms — Plastic Base	171
SJTC-101X	Soji – Task Stool with Fixed Arms — Aluminum Base	172

## Index

<b>Product Code</b>	<b>Product Description</b>	<b>Page</b>
SJTC-101X	Soji – Task Stool with Fixed Arms — Plastic Base	171
SJTC-401A	Soji – Task Stool with Height Adjustable Arms — Aluminum Base	170
SJTC-401A	Soji – Task Stool with Height Adjustable Arms — Plastic Base	169
SJTC-401X	Soji – Task Stool with Height Adjustable Arms — Aluminum Base	170
SJTC-401X	Soji – Task Stool with Height Adjustable Arms — Plastic Base	169
SJTC-701A	Soji – Task Stool with 4D Arms — Aluminum Base	168
SJTC-701A	Soji – Task Stool with 4D Arms — Plastic Base	167
SJTC-701X	Soji – Task Stool with 4D Arms — Aluminum Base	168
SJTC-701X	Soji – Task Stool with 4D Arms — Plastic Base	167
SLP-22-R	Poppy – Swivel	264
SLP-22-S	Poppy – Swivel	264
SLP-22-T	Poppy – Basket	264
SMCH-2256-HS	Riverbend – 90°	246
SMCH-2258-HS	Riverbend – 60°	247
SMCM-2256-HS	Riverbend – 90°	246
SMCM-2258-HS	Riverbend – 60°	247
SMCN-2056-HS	Riverbend – 90°	246
SMCN-2058-HS	Riverbend – 60°	247
SMG-1	Riverbend Accessories – Ganging Bracket	251
SMQM-2240-H	Riverbend – Corner – Square	249
SMQN-2040-H	Riverbend – Corner – Square	249
SMSH-2255-H	Riverbend – Double Seat	244
SMSH-2267-H	Riverbend – Triple Seat	245
SMSM-2228-H	Riverbend – Single Seat	243
SMSM-2255-H	Riverbend – Double Seat	244
SMSM-2267-H	Riverbend – Triple Seat	245
SMSN-2028-H	Riverbend – Single Seat	243
SMSN-2055-H	Riverbend – Double Seat	244
SMSN-2067-H	Riverbend – Triple Seat	245
SMVH-2258-HS	Riverbend – 60° Convex	248
SMVM-2258-HS	Riverbend – 60° Convex	248
SODB-2424-P	Openest Collection – Round	258
SODC-1616-P	Openest Collection – Round	258
SON-3	Openest Collection – Plume 3	253
SON-6	Openest Collection – Plume 6	253
SON-9	Openest Collection – Plume 9	253
SOPB-2223	Openest Collection – Chick Pouf with Back	255
SOPN-2223	Openest Collection – Chick Pouf without Back	255
SOPN-2238	Openest Collection – Large Square - No Back	256
SOPN-2252	Openest Collection – Rectangle - No Back	256
SOPN-2265	Openest Collection – Round - No Back	257
SORA-5320-P	Openest Collection – Rectangle	258
SOSR-1-RW	Openest Collection – Feather – Asymmetrical	254
SOSS-1-RW	Openest Collection – Feather – Symmetrical	254
SPG-11-4	Poppy – Four Star Base with Glides	262
SPG-11-5	Poppy – Five Star Base with Casters	262
SPG-11-7	Poppy – Sled Base	263
SPG-11-W	Poppy – Wood Base	263
STP-P26-TH	Pip – Personal Laptop Table	259

# Index

<b>Product Code</b>	<b>Product Description</b>	<b>Page</b>
STS-1	Tilt – Stool .....	.275
STSN-2025-HN	Pebble – Ottoman .....	.250
STSN-2033-HN	Pebble – Ottoman .....	.250
STSN-2047-HN	Pebble – Ottoman .....	.250
STSN-2067-HN	Pebble – Ottoman .....	.250
SZG-22-1	Zody – 4 Leg .....	.105
SZG-22-1	Zody – Sled Base .....	.104
SZT-20-002MA1	Zody – Task Chair without Arms .....	.85
SZT-20-102MA1	Zody – Task Chair with Fixed Arms .....	.81
SZT-20-402MA1	Zody – Task Chair with Height Adjustable Arms .....	.77
SZT-20-702MA1	Zody – Task Chair with 4D Arms .....	.73
SZTC-20-002MA1	Zody – Task Stool without Arms .....	.101
SZTC-20-102MA1	Zody – Task Stool with Fixed Arms .....	.97
SZTC-20-402MA1	Zody – Task Stool with Height Adjustable Arms .....	.93
SZTC-20-702MA1	Zody – Task Stool with 4D Arms .....	.89
TQ84-0011	ToDo – Single, Stationary .....	.273
TQ85-0011	ToDo – Single, Mobile .....	.274
X630-3100	X99 – Guest Chair .....	.209
X640-0040	X99 – Without Arms .....	.211
X640-0140	X99 – With Arms .....	.210
X641-2040	X99 – Without Arms .....	.213
X641-2140	X99 – With Arms .....	.212



## Product Compatibility and Limited Warranty Policy

### Great Expectations

You have them as a Haworth customer and so do we. And because we value our customers, we cover our products with the Haworth North America Product Compatibility and Limited Warranty Policy.

### Our Commitment To Product Compatibility – Integrated Product Platforms

As a market leader in the design and manufacture of workspaces that adapt to change, we strive to maintain product compatibility within our various generations of integrated product platforms. This benefits the customer who desires to update or modify their work environment. It also benefits the customer needing to replace a product due to damage or other reasons but which is no longer manufactured or is otherwise unavailable, such as a fabric or finish that is discontinued because of changing market preferences. In both circumstances, we often can provide products with comparable function and performance.

### Our Commitment To Product Quality – The Haworth North America Limited Warranty

To ensure customer satisfaction and peace of mind, we stand behind our products with the Haworth North America Limited Warranty. To review the current version of the limited warranty including its terms and conditions, please go to:

**[www.haworth.com/warranty](http://www.haworth.com/warranty) or contact [OneTouch@Haworth.com](mailto:OneTouch@Haworth.com) or 1 877 429 6784.**

### Warranty Requests or Questions

For questions or service requests pertaining to the Haworth Limited Warranty, please contact your Haworth dealer.

If you are unsure who your dealer is, please contact **[OneTouch@Haworth.com](mailto:OneTouch@Haworth.com) or 1 877 429 6784.**

**Effective: September 1, 2021**

## Terms of Sale

The Terms of Sale apply to all products in the North America Price Lists. To review the current version of the North American Terms of Sale, please go to:

**[www.haworth.com/terms-of-sale](http://www.haworth.com/terms-of-sale) or contact [OneTouch@Haworth.com](mailto:OneTouch@Haworth.com) or 1 877 429 6784.**

**Effective: September 2, 2022**

# HAWORTH

HAWORTH® is a registered trademark of Haworth, Inc.  
© Haworth, Inc. All rights reserved. 2024.2.24 | Item #LIT21024  
haworth.com | 800 344 2600

**Conference Chair – Nesting**



BWSM-44-1

**Dimensions**

- \*SH: 18.5”(470mm)
- H: 32.9”(836mm)
- D: 23.9”(607mm)
- W: 25.2”(640mm)
- \*SW: 20.5”(521mm)
- \*SD: 17.5”(445mm)
- \*AH: 8.7”(221mm)

\* All measurements taken with the BIFMA chair measuring device.

**Features**

- Includes: **Two** nesting chairs with polypropylene seat and back.
- Seat/Back shell: Polypropylene in TR-F Black, TR-G Gray Tone or TR-UPLS Smooth Plaster.
- Frame with integrated arms: Plastic in TR-F Black or TR-UPLS Smooth Plaster.
- Casters:
  - Hard - Black or Two-tone (white/gray)
  - Soft - Black
- Nesting: Single lever under the seat engages the nesting mechanism tilting the seat forward. When seat shell is tilted up, the mechanism clicks to inform the user the chair is ready to use. Each additional nested chair adds 8.25”(210mm) of depth.

**To Order, Specify:**

- 1) Product number, including;
  - 1** Caster Option:
    - 1** Hard, black casters
    - 2** Soft, black casters
    - T** Two-tone casters (add **\$40.00** list)
- 2) Frame color. (Smooth Plaster (TR-UPLS) add **\$150.00** list)
- 3) Shell color.

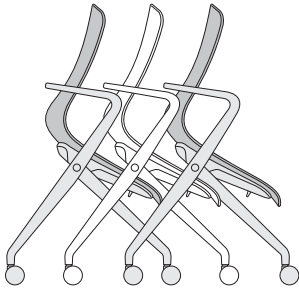

**Specification Tip**

- Ordering quantity is the number of boxes you will receive. Each box contains (2) identical chairs. When ordering a quantity of (1), you will receive (1) box containing (2) chairs. When ordering a quantity of (2), you will receive (2) boxes containing (2) chairs each for a total of (4) chairs.

**Description**

**Number 1**

**Price**

One box/Two chairs

BWSM-44-1

**\$1240.00**

# Soji XL

## Task Chair



SJTX-101A

### Dimensions

- \*SH: 17.0"-21.7"  
(432mm-551mm)
- H: 40.3"-45.0"  
(1024mm-1143mm)
- D: 27"(686mm)
- W: 28.75"(730mm)
- \*SW: 24.5"(622mm)
- \*SD: 16.9"-18.5"  
(429mm-470mm)
- \*AH: 7.8"-11.7"  
(178mm-297mm)

\* All measurements taken with the BIFMA chair measuring device.

### Features

- Back: Knit or upholstered.
- Adjustable Seat: Standard upholstered foam covered in leather, fabric or faux leather.
- Base: Plastic five-star base with hard casters in black or two-tone grey, or soft casters in black.
- Arms options:
  - No arms
  - Fixed arms
  - Height adjustable; 4"(102mm) height adjustment range.
  - 4D; 4"(102mm) height adjustment, 4"(102mm) side-to-side range, 2"(51mm) front-to-back range and pivots 20° in and 20° out.
- Lumbar: Optional lumbar support has 3.5"(89mm) adjustment.
- Mechanism: Pneumatic
- Back stop in upright position.
- COM yardage/COL square footage: Seat: 1.0/9

### To Order, Specify:

- 1) Product number, including:
  - 1** Seat Material:
    - 1 Leather
    - 2 Fabric
    - 3 Faux Leather
  - 2** Back Material:
    - 0 Knit
    - 1 Leather
    - 2 Fabric
    - 3 Faux Leather
  - 3** Caster Option:
    - 5 Hard - Black
    - 6 Soft - Black, add **\$57.29** list
    - 7 Hard - Two-Tone Grey
- 2) Seat upholstery.
- 3) Back upholstery.
- 4) Trim color (frame and arm uprights).
  - TR-F Black
  - TR-7 Fog, add **\$92.13** list.
  - TR-UFM Snow, add **\$148.82** list.
- 5) Base color.
  - TR-F Black
  - TR-7 Fog

### Specification Tips

- Ships fully assembled.
- Lumbar color defaults based on chair attributes and is available in Black or Fog only.
  - Black will be received if Carbon knit is ordered or plastic trim color is Black.
  - Fog will be received if Fog or Snow plastic trim is ordered and knit is not Carbon.
- Reference color chart for applied backing material for upholstered or cleanable upholstered back.

Plastic Trim Color	Lumbar	Arm Caps	Backing Material for Upholstered Back
TR-F Black	TR-F Black	TR-F Black	Tellure, Black 3A-18
TR-7 Fog	TR-7 Fog*	TR-7 Fog	Tellure, Goose 3A-54
TR-UFM Snow	TR-7 Fog*	TR-7 Fog	Tellure, Goose 3A-54

\*If knit is Carbon, lumbar will be Black.

Plastic Trim Color	Lumbar	Arm Caps	Backing Material for Cleanable Upholstered Back
TR-F Black	TR-F Black	TR-F Black	Wellington, Black XJ-BL
TR-7 Fog	TR-7 Fog*	TR-7 Fog	Wellington, Steel XJ-SL
TR-UFM Snow	TR-7 Fog*	TR-7 Fog	Wellington, Steel XJ-SL

\*If knit is Carbon, lumbar will be Black.

Arm	Number ① ② ③	Fabric Grade A B C D E F G H	Leather Grade									
			A	B								
<b>No Lumbar Adjustment - Knit Back</b>												
No Arm	SJTX- 0-001A A		\$2265.04	\$2309.66	\$2357.49	\$2379.85	\$2398.96	\$2440.42	\$2478.68	\$2580.71	\$2671.58	\$2870.87
Fixed Arm	SJTX- 0-101A A		2344.53	2389.15	2436.98	2459.34	2478.45	2519.91	2558.17	2660.20	2751.07	2950.36
Height Adjustable	SJTX- 0-401A A		2405.37	2449.99	2497.82	2520.18	2539.29	2580.75	2619.01	2721.04	2811.91	3011.20
4D	SJTX- 0-701A A		2431.97	2476.59	2524.42	2546.78	2565.89	2607.35	2645.61	2747.64	2838.51	3037.80
<b>No Lumbar Adjustment - Upholstered Back</b>												
No Arm	SJTX- 0-001A A		\$2413.62	\$2502.86	\$2598.52	\$2643.24	\$2681.46	\$2764.38	\$2840.90	\$3044.96	\$3226.70	\$3625.28
Fixed Arm	SJTX- 0-101A A		2493.11	2582.35	2678.01	2722.73	2760.95	2843.87	2920.39	3124.45	3306.19	3704.77
Height Adjustable	SJTX- 0-401A A		2553.95	2643.19	2738.85	2783.57	2821.79	2904.71	2981.23	3185.29	3367.03	3765.61
4D	SJTX- 0-701A A		2580.55	2669.79	2765.45	2810.17	2848.39	2931.31	3007.83	3211.89	3393.63	3792.21
<b>Lumbar Adjustment - Knit Back</b>												
No Arm	SJTX- 0-011A A		\$2333.07	\$2377.69	\$2425.52	\$2447.88	\$2466.99	\$2508.45	\$2546.71	\$2648.74	\$2739.61	\$2938.90
Fixed Arm	SJTX- 0-111A A		2412.56	2457.18	2505.01	2527.37	2546.48	2587.94	2626.20	2728.23	2819.10	3018.39
Height Adjustable	SJTX- 0-411A A		2473.40	2518.02	2565.85	2588.21	2607.32	2648.78	2687.04	2789.07	2879.94	3079.23
4D	SJTX- 0-711A A		2500.00	2544.62	2592.45	2614.81	2633.92	2675.38	2713.64	2815.67	2906.54	3105.83
<b>Lumbar Adjustment - Upholstered Back</b>												
No Arm	SJTX- 0-011A A		\$2481.65	\$2570.89	\$2666.55	\$2711.27	\$2749.49	\$2832.41	\$2908.93	\$3112.99	\$3294.73	\$3693.31
Fixed Arm	SJTX- 0-111A A		2561.14	2650.38	2746.04	2790.76	2828.98	2911.90	2988.42	3192.48	3374.22	3772.80
Height Adjustable	SJTX- 0-411A A		2621.98	2711.22	2806.88	2851.60	2889.82	2972.74	3049.26	3253.32	3435.06	3833.64
4D	SJTX- 0-711A A		2648.58	2737.82	2833.48	2878.20	2916.42	2999.34	3075.86	3279.92	3461.66	3860.24

The following options require modification of the product number.

- Stain Repellent (fabric surfaces only)
- Fully Cleanable Back

To specify, add **P** to the end of the product number and add **\$49.61** list; **Example:** SJTX-22-401A5AP  
 To specify, change the sixth digit to **C** and add **\$38.95** list to upholstered back list price; **Example:** SJTX-2C-401A5A  
**Note:** Inner back must be Faux Leather to have a fully cleanable back.