

HAWORTH

Cabana Lounge

North America Price List – February 2024





This Haworth North American price book contains US list prices.

Canadian customers can convert the US list price into their Canadian equivalent by going to www.Haworth.com/Canada to find the current Canadian multipliers. These multiplier factors allow you to convert the US list price into a Canadian list price.

Price List Overview

The following overview explains how information is organized within the Cabana Lounge™ price list.

- 1 Front Cover**
 - Includes the price book title and pricing effectivity date.
- 2 Canadian Conversion / Update Page**
 - Pricing conversion information for converting US pricing into the equivalent Canadian pricing is located on the footer of this page.
 - All Price Book updates will be listed on this page including the date, page number and description of the update.
- 3 Price List Table of Contents**
 - Price List table of contents with page numbers.
- 4 Statement of Line**
 - Provides a pictorial outline of the entire product offering.
- 5 Price List**

Each price list page contains the following:

 - Product Illustration
 - Catalog Number
 - To Order Specify – sequencing for ordering product options and finishes
 - List Prices
 - Product Specification Dimensions
 - Features
 - Specification Tips
 - Class, Discount Group Number (used for discounting) and GSA information
- 6 Finishes, Fabrics and COM**
 - Lists information for material finishes and availability.
 - Provides COM information and requirements (if applicable).
- 7 Index**
 - Products are listed alphabetically by alpha-numeric catalog numbers with price list page number.
- 8 Product Non-Obsolescence and Warranty Policy**
 - Provides information about the Haworth policy for non-obsolescence, warranty and Terms-of-Sale.

Additional Information and Resources

Prices are subject to change without notice or approval. Haworth dealers should always submit proposals through Lynx before presenting to customers. See North American Terms of Sale for more information.

Online Resources

- haworth.com**
 - Haworth's corporate website provides access to price books and a variety of other resources and publications.
- surfaces.haworth.com**
 - Website provides access to the most current fabrics and finishes offered across Haworth's various product lines.

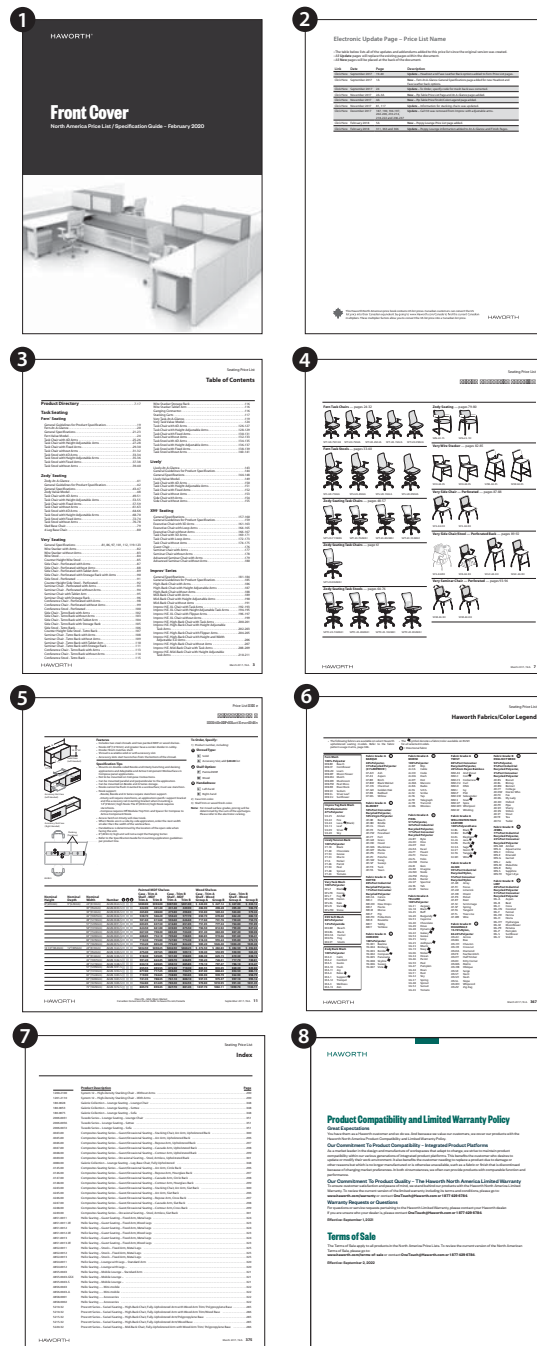
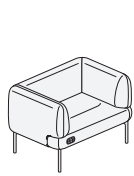

Table of Contents

Statement of Line	5-7
At-A-Glance	8
General Specifications - Seating	9
General Specifications - Tables	10
Individual Lounge	11
Corner Sofa	12
Single Seat Sofa	14
Two-Seat Collaborative Sofa	17
Chaise Lounge	20
Tables	
Square	22
Square Tiered	24
Rectangle	26
Rectangle Tiered	28
Wedge	30
Wedge Tiered	32
Chaise Lounge Retreat	34
Half-Back Sofa Retreat	37
Lounge Island	
Lounge Island	40
Island Screen	42
Island Screen Ganging Bracket	42
Accessories	
Ganging Bracket	43
Ganging Kit	43
Shelf	44
Coat Hook	44
Connector Screen	45
Shelf with Monitor Mount	45
Bezel Utility Module	
Bezel Utility Module	46
Data Bezel	46
Finishes and Fabrics	
Finish/Color Legend	47
Fabrics/Color Legend	48
COM Yardage Requirements	49
Index	50-51
Lifetime Product Warranty	Inside Back Cover

Statement of Line

Individual Lounge — page 11



S9L2-0

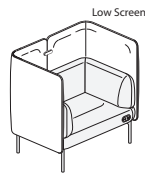

S9L2-L

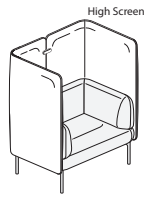

S9L2-H

Corner Sofa — page 12



S9AL-0

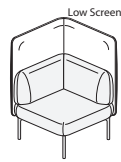

S9AL-L

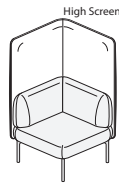

S9AL-H

Single Seat Sofa — pages 14-15

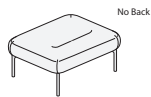

S9B0-0

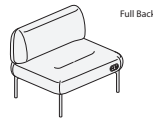

S9BB-0

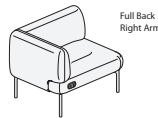

S9BR-0

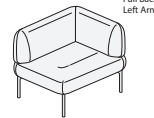

S9BL-0

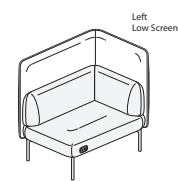

S9BL-L

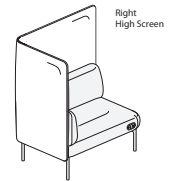

S9BR-H

Two-Seat Collaborative Sofa — pages 17-19

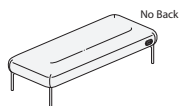

S9C0-0

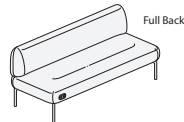

S9CB-0

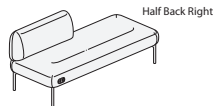

S9CH-0

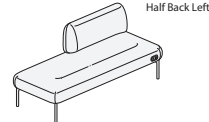

S9CZ-0

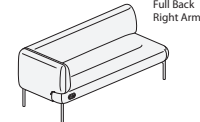

S9CR-0

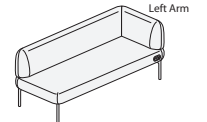

S9CL-0

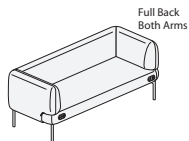

S9C2-0

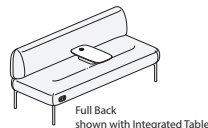

S9CB-0

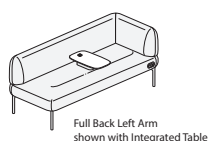

S9CL-0

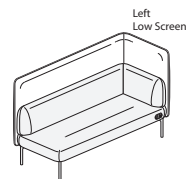

S9CL-L

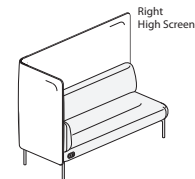

S9CR-H

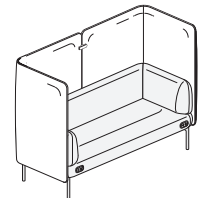

S9C2-H

Chaise Lounge — pages 20-21

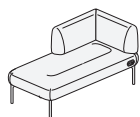

S9DT-0

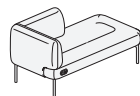

S9DC-0

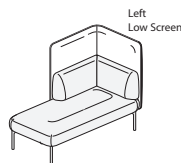



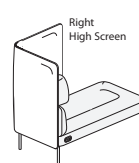

S9DT-L

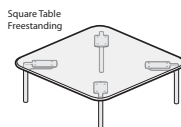
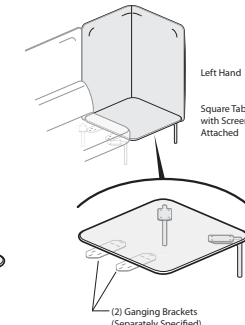
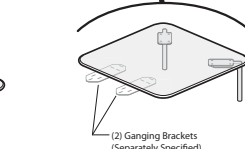
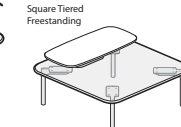
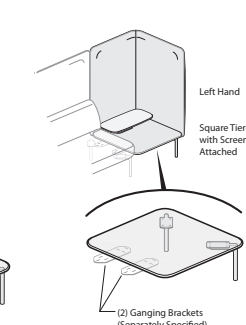
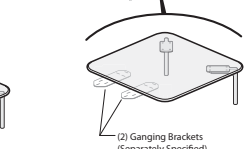
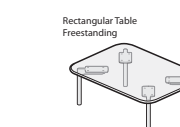
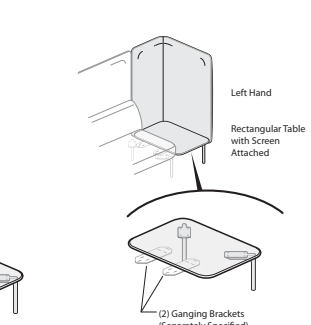
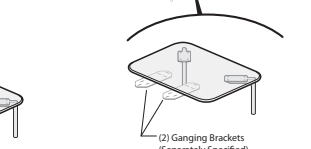
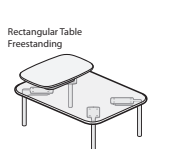
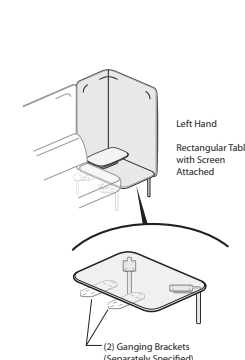
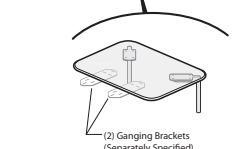
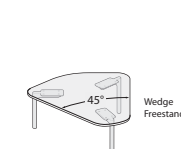
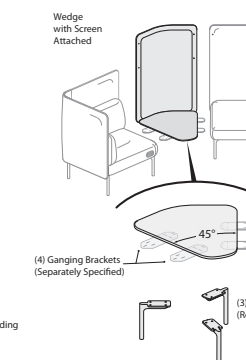
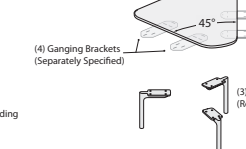

S9DC-H

Statement of Line

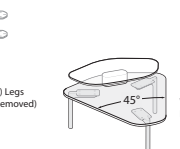
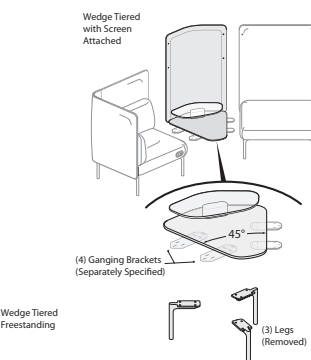
Tables — pages 22-33

 <p>Square Table Freestanding</p> <p>S910 Square</p>	 <p>Left Hand Square Table with Screen Attached</p>  <p>(2) Ganging Brackets (Separately Specified)</p> <p>S914 Square</p>	 <p>Square Tiered Freestanding</p> <p>S920 Square Tiered</p>	 <p>Left Hand Square Tiered with Screen Attached</p>  <p>(2) Ganging Brackets (Separately Specified)</p> <p>S924 Square Tiered</p>	 <p>Rectangular Table Freestanding</p> <p>S930 Rectangle</p>	 <p>Left Hand Rectangular Table with Screen Attached</p>  <p>(2) Ganging Brackets (Separately Specified)</p> <p>S934 Rectangle</p>
 <p>Rectangular Table Freestanding</p> <p>S940 Rectangle Tiered</p>	 <p>Left Hand Rectangular Table with Screen Attached</p>  <p>(2) Ganging Brackets (Separately Specified)</p> <p>S944 Rectangle Tiered</p>	 <p>45° Wedge Freestanding</p> <p>S950 Wedge</p>	 <p>Wedge with Screen Attached</p>  <p>45° (4) Ganging Brackets (Separately Specified)</p>  <p>(3) Legs (Removed)</p> <p>S956 Wedge</p>	 <p>45° Wedge Tiered Freestanding</p> <p>S960 Wedge Tiered</p>	 <p>Wedge Tiered with Screen Attached</p>  <p>45° (4) Ganging Brackets (Separately Specified)</p>  <p>(3) Legs (Removed)</p> <p>S966 Wedge Tiered</p>

Chaise Lounge Retreat — pages 34-35

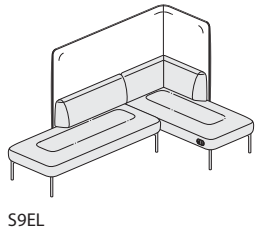

Half-Back Sofa Retreat — pages 37-39

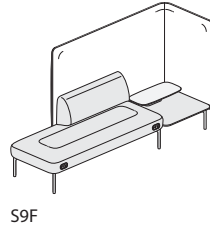

Lounge Island — pages 40-42

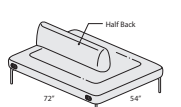
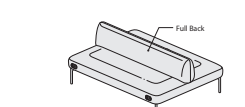
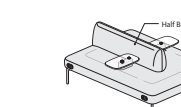
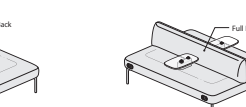
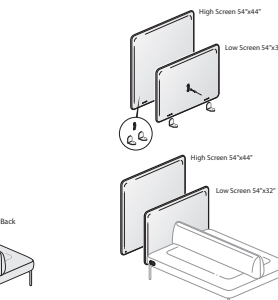
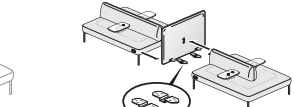
 <p>Half Back 72" 54"</p> <p>S9GK-2_OH</p>	 <p>Full Back</p> <p>S9GB-2_OH</p>	 <p>Half Back</p> <p>S9GK-2_PH</p>	 <p>Full Back</p> <p>S9GB-2_PH</p>	 <p>High Screen 54"x44" Low Screen 54"x32"</p> <p>S9GS-L2 S9GS-H2 Island Screen</p>	 <p>S9G-A0 Island Screen Ganging Bracket</p>
---	--	--	--	--	--

Statement of Line

Accessories — pages 43-46

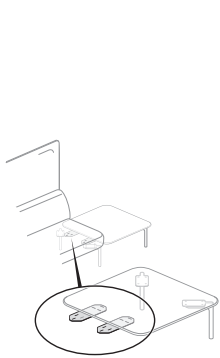

S9G-00
Ganging Bracket

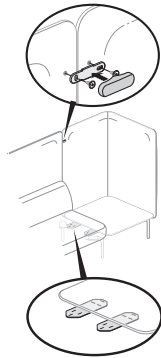

S9G-10
Ganging Kit

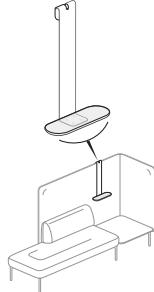

S9SL
Shelf

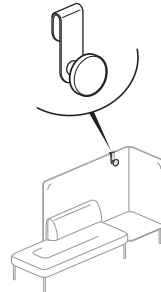

HOCH-0000
Coat Hook

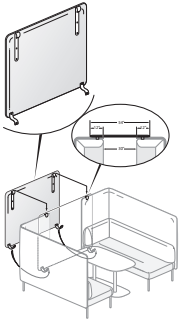

S9SH-20
Connector Screen

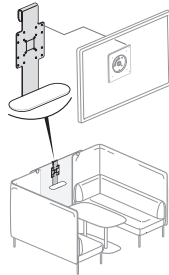

S9SP
S9SW
Shelf with Monitor Mount

Bezel Utility Module — page 47

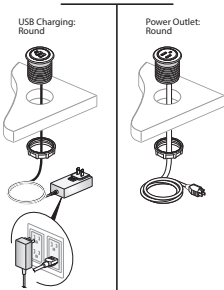

EURT-0072-1100
EURT-0072-1010
Bezel Utility Module

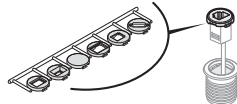

EURT-0000-N001CB
EURT-0000-N001CW
Data Bezel

At-A-Glance

General Specifications

Designer	Patricia Urquiola - Studio Urquiola
Cabana Lounge	Cabana Lounge is a light-scale sofa system designed to deliver optimal user performance, comfort and design to create unique destination spaces in the office.
Awards	Best of Neocon Gold Award 2019 - Lounge Furniture Collection HiP Award - Workplace: High-Back Seating

Products shown:

- Two-Seat Collaborative Sofa, Full Back, Right and Left Arms, High Screen
- Two-Seat Collaborative Sofa, Full Back, Left Arm, Embedded Power - Left, High Screen
- Ganging Kit
- Single Seat Sofa, No Back
- (2) Pip Personal Laptop Table
- Openest Pillow

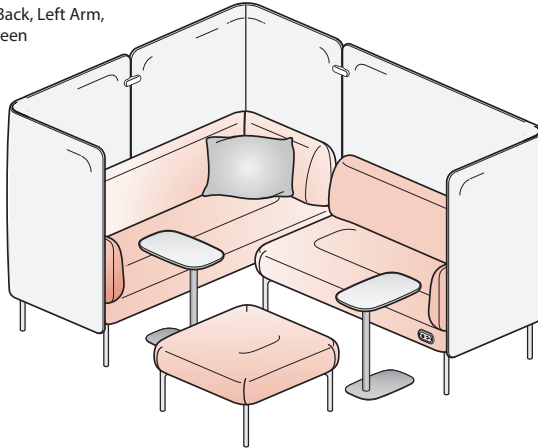

Products Shown:

- Chaise Lounge Retreat, Embedded Power - Left, High Screen
- Single Seat Sofa, No Back
- Pip Personal Laptop Table
- Openest Pillow

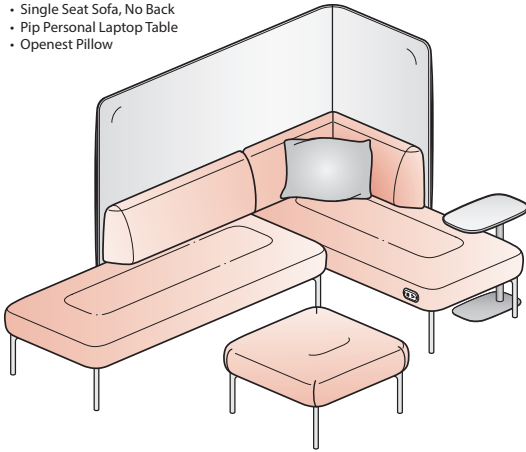

Products Shown:

- (2) Single Seat Sofa, Full Back, Right Arm, High Screen
- (2) Ganging Brackets
- Tiered Table - Rectangular
- (2) Bezel Utility Modules
- Single Seat Sofa, No Back
- Coat Hook
- Pip Personal Laptop Table

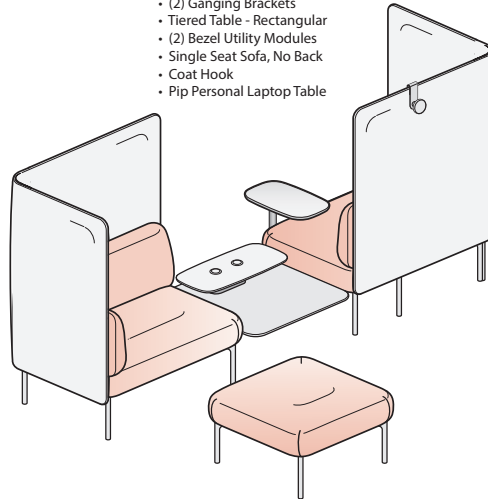

Products Shown:

- Two-Seat Collaborative Sofa, Full Back, Right Arm, Integrated Table, Low Screen
- Two-Seat Collaborative Sofa, Full Back, Left Arm, Integrated Table, Low Screen
- Tiered Table - Wedge, Low Screen
- (2) Ganging Kits
- (6) Bezel Utility Modules

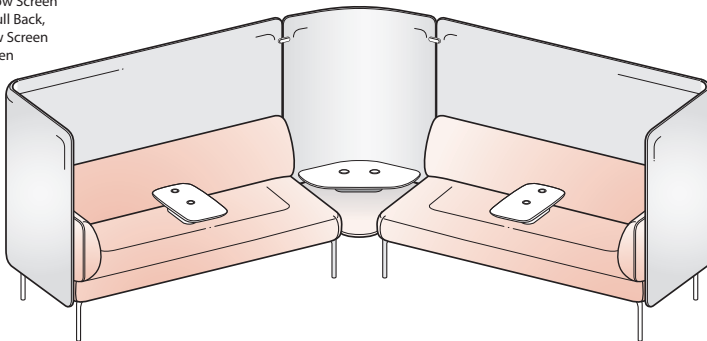

Cabana Lounge

General Specifications - Seating

General Guidelines for Product Specification

	S	9	C	R	L	2	2	-	1	0	0	H
Product Type	_____											
(S) Seating	_____											
Product Line	_____											
(9) Cabana Lounge	_____											
Model	_____											
(A) Corner Sofa	_____											
(B) Single Seat Sofa	_____											
(C) Two-Seat Collaborative Sofa	_____											
(D) Chaise Lounge	_____											
(L) Individual Lounge	_____											
(E) Chaise Lounge Retreat	_____											
(F) Half-Back Sofa Retreat	_____											
Back/Arm Type	_____											
(0) No Back or Arm	_____											
(B) Back only	_____											
(R) Back and Right-Hand Arm	_____											
(L) Back and Left-Hand Arm	_____											
(2) Back and Both Arms	_____											
(H) Right Half-Back	_____											
(Z) Left Half-Back	_____											
(C) Right-Hand Chaise	_____											
(T) Left-Hand Chaise	_____											
Screen Type	_____											
(0) No Screen	_____											
(L) Low Screen	_____											
(H) High Screen	_____											
Lounge Upholstery	_____											
(1) Leather	_____											
(2) Fabric	_____											
Screen Upholstery	_____											
(0) No Screen	_____											
(2) Fabric Screen	_____											
Embedded Power	_____											
(0) No Power	_____											
(1) Power - Right-Hand, Black	_____											
(A) Power - Right-Hand, White	_____											
(2) Power - Left-Hand, Black	_____											
(B) Power - Left-Hand, White	_____											
(3) Power - Both, Black	_____											
(C) Power - Both, White	_____											
(4) Power + USB - Right-Hand, Black	_____											
(D) Power + USB - Right-Hand, White	_____											
(5) Power + USB - Left-Hand, Black	_____											
(E) Power + USB - Left-Hand, White	_____											
(6) Power + USB - Both, Black	_____											
(F) Power + USB - Both, White	_____											
Integrated Table	_____											
(0) No Integrated Table	_____											
(P) Painted MDF	_____											
(W) Wood	_____											
Square Corner Table	_____											
(0) None	_____											
(1) Single Tier - MDF	_____											
(2) Single Tier - Wood	_____											
(3) Two-Tier - MDF, MDF	_____											
(4) Two-Tier - MDF, Wood	_____											
(5) Two-Tier - Wood, MDF	_____											
(6) Two-Tier - Wood, Wood	_____											
Glide Option	_____											
(H) Plastic	_____											
(F) Felt	_____											

Cabana Lounge

General Specifications - Tables

General Guidelines for Product Specification

	<u>S</u>	<u>9</u>	<u>1</u>	<u>1</u> -	<u>W</u>	<u>W</u>	<u>2</u> -	<u>H</u>
Product Type	_____							
(S) Seating	_____							
Product Line	_____							
(9) Cabana Lounge	_____							
Model	_____							
(1) Square Table	_____							
(2) Square Tiered Table	_____							
(3) Rectangle Table	_____							
(4) Rectangle Tiered Table	_____							
(5) Wedge Table	_____							
(6) Wedge Tiered Table	_____							
(7) Pip Collaborative Table	_____							
Screen Type	_____							
(0) No Screen	_____							
(1) Right-Hand Low	_____							
(2) Right-Hand High	_____							
(3) Left-Hand Low	_____							
(4) Right-Hand High	_____							
(5) Wedge Low	_____							
(6) Wedge High	_____							
Table Surface	_____							
(L) Laminate	_____							
(P) Painted MDF	_____							
(W) Plank Wood	_____							
(V) Wood Veneer	_____							
Upper Table Surface	_____							
(P) Painted MDF	_____							
(W) Plank Wood	_____							
Screen Upholstery	_____							
(0) No Screen	_____							
(2) Fabric Screen	_____							
Glide Option	_____							
(H) Plastic	_____							
(F) Felt	_____							

Individual Lounge*

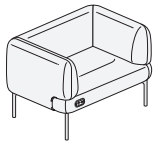

S9L2-0

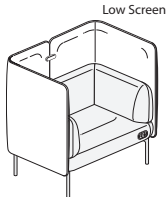

S9L2-L

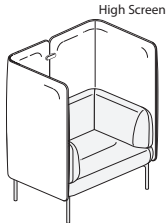

S9L2-H

Dimensions

- *SH: 17.3"(439mm)
- H: 30.5"(775mm)
- No Screen 42"(1067mm)
- Low Screen 54"(1372mm)
- High Screen
- D: 30"(762mm)
- No Screen 32"(813mm)
- With Screen
- W: 42"(1067mm)
- No Screen 46"(1168mm)
- With Screen
- SW: 24"(610mm)
- *SD: 21.125"(537mm)

* All measurements taken with the BIFMA chair measuring device.

Features

- Includes: Individual lounge chair with back and right and left hand arms on four legs.
- Optional Low or High Screen available. Two-piece screen will surround both sides and back. Screens will be connected with Screen Alignment Clip.
- Embedded Power is available in two options:
 - Power - Two Power Receptacles (NEMA-5-15R) per location
 - Power + USB - One Power Receptacle (NEMA-5-15R) and two stacked USB 2.0 ports (2A of charging power[5 volts] per USB outlet).
- Power is embedded on seat front on left or right-hand side.
- Legs - painted cast aluminum.
- Glides - Black plastic or felt with 0.5"(13mm) leveling adjustment.
- COM yardage/COL square footage: (COL N/A on screens)
Seat/back/arms: 5.00/82.5
Screen Low: 6.25/N/A High: 6.5/N/A

Specification Tips

- Individual Lounge is not designed to be ganged to other Cabana products due to interference with back, arms and screen.
- Lounge and screen fabric are applied railroaded.
- Linear or patterned fabric not recommended due to the way material is applied.
- Seat and Screen may be specified with different materials. To specify, select seat material grade. Next, select screen material and add appropriate upcharge (see chart).
- When ordering with screens please note the change in Number:
 - No Screen S9L2-0
 - Low Screen S9L2-L
 - High Screen S9L2-H
- Embedded Power is factory installed and cannot be field installed. Power type can be field modified with service parts.
- **For use with 120 volt 60 hertz electrical system only.**
- Place powered seating within 4'(1219mm) of power source. Power components ship with 10'(3048mm) cord routed to an opening at rear of seating unit.
- The following separately specified items are designed to work with Cabana screens. It is recommended to use these items on High Screens or placed over a table to prevent interference with user.
 - Shelf S9SH-0
 - Coat Hook HOCH-0000
- See Specification Guide for Application Details.
- Powered applications may require approval of local authority having jurisdiction (AHJ); ensure compliance before placing orders and installing.

To Order, Specify:

1) Product number, including:

1 Seat Upholstery Type:

- 1 Leather
- 2 Fabric

2 Power Option:

- 0 None
- Power*
- 1 Right Power - Black, add **\$324.41** to list
- A Right Power - White, add **\$324.41** to list
- 2 Left Power - Black, add **\$324.41** to list
- B Left Power - White, add **\$324.41** to list

Power + USB

- 4 Right Power + USB - Black, add **\$409.03** to list
- D Right Power + USB - White, add **\$409.03** to list
- 5 Left Power + USB - Black, add **\$409.03** to list
- E Left Power + USB - White, add **\$409.03** to list

3 Glide Option:

- H Plastic Glide
- K Felt Glide

- 2) Seat, back and arm material.
- 3) Screen material (if applicable). See chart (below) for upcharge.
- 4) Trim color.

Description	Number	Seat, Back & Arms Fabric Grade								Leather Grade A	Leather Grade B		
		1	2	3	A	B	C	D	E			F	G
No Screen	S9L2-0	0-	00	\$3424.60	\$3727.86	\$3890.04	\$4214.45	\$4440.13	\$5483.86	\$6104.47	\$7225.78	\$6174.98	\$7310.41
Low Screen*	S9L2-L	2-	00	\$253.96	\$557.22	\$719.40	\$6043.81	\$6269.49	\$7313.22	\$7933.83	\$9055.14	\$8004.34	\$9139.77
High Screen*	S9L2-H	2-	00	\$253.96	\$557.22	\$719.40	\$6043.81	\$6269.49	\$7313.22	\$7933.83	\$9055.14	\$8004.34	\$9139.77

*Pricing shown for Low and High Screen reflects screen Grade A pricing. Reference chart for upcharge amounts for higher grade pricing.

The following option requires modification of the product number.

Stain repellent (not applicable to screens) To specify, add **P** to the end of the product number; **Example:** S9L2-020-100HP (add **\$141.16** to list)

Description	A	B	C	D	E	F	G	H
Low Screen (2) 30" x 21"	N/A	\$423.14	\$648.81	\$1100.16	\$1424.56	\$2877.33	\$3751.81	\$5317.41
High Screen (2) 30" x 21"	N/A	\$423.14	\$648.81	\$1100.16	\$1424.56	\$2877.33	\$3751.81	\$5317.41

*This product may be subject to supplemental freight charges.

Corner Sofa*

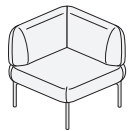

S9AL-0

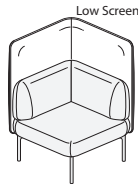

S9AL-L

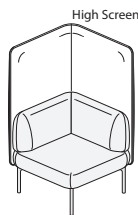

S9AL-H

Dimensions

- *SH: 17.3"(439mm)
- H: 30.5"(775mm)
- No Screen 42"(1067mm)
- Low Screen 54"(1372mm)
- High Screen
- D: 30"(762mm)
- No Screen 32"(813mm)
- With Screen
- W: 30"(762mm)
- No Screen 32"(813mm)
- With Screen
- SW: 21"(533mm)
- *SD: 21.125"(537mm)

* All measurements taken with the BIFMA chair measuring device.

Features

- Includes: Corner unit with back and right or left hand arm on four legs.
- Optional Low or High Screen available. Screen attaches to arm and back. Unit with right arm will have a 30"(762mm)D x 30"(762mm)W right-hand screen.
- Legs - painted cast aluminum.
- Glides - Black plastic or felt with 0.5"(13mm) leveling adjustment.
- COM yardage/COL square footage: (COL N/A on screens) Seat/back/arm: 3.5/57.5 Screen Low: 3.75/N/A High: 4.0/N/A

Specification Tips

- Gangs with separately specified Cabana seating or tables with or without a screen. Use separately specified Ganging Bracket or Ganging Kit.
- Cannot gang on arm, back or screen locations due to interference. For options see Specification Guide.
- Seat and Screen may be specified with different materials. To specify, select seat material grade. Next, select screen material and add appropriate upcharge (see chart).
- Sofa and screen fabric are applied railroaded.
- Linear or patterned fabric not recommended due to the way material is applied.
- When ordering with screens please note the change in Number:
 - No Screen S9A_0
 - Low Screen S9A_L
 - High Screen S9A_H
- The following separately specified items are designed to work with Cabana screens. It is recommended to use these items on High Screens or placed over a table to prevent interference with user.
 - Shelf S9SH-0
 - Coat Hook HOCH-0000
- See Specification Guide for Application Details.

To Order, Specify:

1) Product number, including:

1 Seat Upholstery Type:

- 1 Leather
- 2 Fabric

2 Glide Option:

- H Plastic Glide
- K Felt Glide

- 2) Seat, back and arm material.
- 3) Screen material (if applicable). See chart (below) for upcharge.
- 4) Leg color.

Description	Number		Seat, Back & Arms Fabric Grade								Leather Grade A	Leather Grade B
	1	2	A	B	C	D	E	F	G	H		
No Screen												
Full Back/Arm	S9AR-0	0-000	\$2961.98	\$3201.76	\$3335.75	\$3596.68	\$3773.01	\$4605.16	\$5105.87	\$6001.51	\$5183.45	\$6093.19
Low Screen*												
Full Back/Right Arm	S9AR-L	2-000	\$3981.74	\$4221.52	\$4355.51	\$4616.44	\$4792.77	\$5624.92	\$6125.63	\$7021.27	\$6203.21	\$7112.95
Full Back/Left Arm	S9AL-L	2-000	\$3981.74	\$4221.52	\$4355.51	\$4616.44	\$4792.77	\$5624.92	\$6125.63	\$7021.27	\$6203.21	\$7112.95
High Screen*												
Full Back/Right Arm	S9AR-H	2-000	\$3981.74	\$4221.52	\$4355.51	\$4616.44	\$4792.77	\$5624.92	\$6125.63	\$7021.27	\$6203.21	\$7112.95
Full Back/Left Arm	S9AL-H	2-000	\$3981.74	\$4221.52	\$4355.51	\$4616.44	\$4792.77	\$5624.92	\$6125.63	\$7021.27	\$6203.21	\$7112.95

*Pricing shown for Low and High Screen reflects screen Grade A pricing. Reference chart for upcharge amounts for higher grade pricing.

The following option requires modification of the product number.

Stain repellent
(not applicable to screens)

To specify, add **P** to the end of the product number; **Example:** S9AL-020-000HP (add \$112.83 to list)

Description	A	B	C	D	E	F	G	H
Low Screen 30" x 30"	N/A	\$239.78	\$373.78	\$634.70	\$811.02	\$1643.19	\$2143.89	\$3039.53
High Screen 30" x 30"	N/A	\$239.78	\$373.78	\$634.70	\$811.02	\$1643.19	\$2143.89	\$3039.53

*This product may be subject to supplemental freight charges.

This page intentionally blank

Single Seat Sofa*

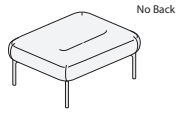

S9B0-0

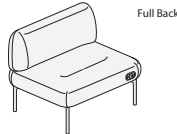

S9BB-0

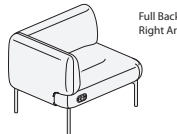

S9BR-0

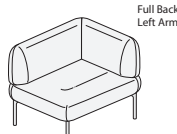

S9BL-0

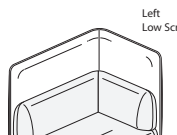

S9BL-L

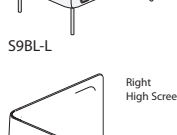

S9BR-H

Dimensions

*SH: 17.3"(439mm)

H: 30.5"(775mm)

No Screen

42"(1067mm)

Low Screen

54"(1372mm)

High Screen

D: 30"(762mm)

No Screen

32"(813mm)

With Screen

W: 36"(914mm)

SW: 27"(686mm)

With Arm

36"(914mm)

Without Arm

*SD: 21.125"(537mm)

With Back

30"(762mm)

Without Back

* All measurements taken with the BIFMA chair measuring device.

Features

- Includes: Single seat sofa with optional back and right or left arm on four legs.
- Optional Low or High Screen available. Screen attaches to arm and back. Unit with right arm will have a right-hand 30"(762mm)D x 36"(914mm)W screen.
- Embedded Power available in two options:
 - Power - Two Power Receptacles (NEMA-5-15R) per location
 - Power + USB - One Power Receptacle (NEMA-5-15R) and two stacked USB 2.0 ports (2A of charging power[5 volts] per USB outlet).
- Power is embedded on seat front on left or right-hand side.
- Power housing available in supplier Black or White with 10'(3048mm) black cord.
- Legs - painted cast aluminum.
- Glides - Black plastic or felt with 0.5"(13mm) leveling adjustment.
- COM yardage/COL square footage: (COL N/A on screens)
 - Seat only: 1.75/28.5
 - Seat/back: 3.0/50.0
 - Seat/back/arm: 3.75/63.5
 - Screen Low: 4.25/N/A High: 4.5/N/A

Specification Tips

- Gangs on open seat depth to separately specified Cabana seating or tables with or without a screen. Use separately specified Ganging Bracket or Ganging Kit.
- Cannot gang on arm, back or screen locations due to interference. For options see Specification Guide.
- Sofa and screen fabric are applied railroaded.
- Linear or patterned fabric not recommended due to the way material is applied.
- Seat and Screen may be specified with different materials. To specify, select seat material grade. Next, select screen material and add appropriate upcharge (see chart).
- When ordering with screens please note the change in Number:
 - No Screen S9B_**0**
 - Low Screen S9B_**L**
 - High Screen S9B_**H**
- Embedded Power is factory installed and cannot be field installed. Power type can be field modified with service parts.
- For use with 120 volt 60 hertz electrical system only.**
- Place powered seating within 4'(1219mm) of power source. Power components ship with 10'(3048mm) cord routed to a corresponding opening at rear of seating unit.
- The following separately specified items are designed to work with Cabana screens. It is recommended to use these items on High Screens or placed over a table to prevent interference with user.
 - Shelf S9SH-0
 - Coat Hook HOCH-0000
- See Specification Guide for Application Details.
- Powered applications may require approval of local authority having jurisdiction (AHJ); ensure compliance before placing orders or installing.

To Order, Specify:

1) Product number, including:

1 Seat Upholstery Type:

- 1 Leather
- 2 Fabric

2 Power Option:

0 None

Power

1 Right Power - Black, add \$324.41 to list

A Right Power - White, add \$324.41 to list

2 Left Power - Black, add \$324.41 to list

B Left Power - White, add \$324.41 to list

Power + USB

4 Right Power + USB - Black, add \$409.03 to list

D Right Power + USB - White, add \$409.03 to list

5 Left Power + USB - Black, add \$409.03 to list

E Left Power + USB - White, add \$409.03 to list

3 Glide Option:

H Plastic Glide

K Felt Glide

2) Seat, back and arm material.

3) Screen material (if applicable). See chart (next page) for upcharge.

4) Leg color.

*This product may be subject to supplemental freight charges.

Single Seat Sofa

Description	Number			Seat, Back & Arms Fabric Grade								Leather Grade A	Leather Grade B
	①	②	③	A	B	C	D	E	F	G	H		
No Screen													
No Back	S9B0-0	0-	00	\$2320.22	\$2411.90	\$2461.27	\$2560.00	\$2623.48	\$2940.82	\$3124.17	\$3462.68	\$3237.02	\$3575.53
Full Back	S9BB-0	0-	00	3141.10	3310.35	3394.98	3578.34	3705.30	4276.53	4615.04	5235.63	4706.70	5334.36
Full Back/Right Arm	S9BR-0	0-	00	3634.76	3874.54	4008.53	4269.46	4445.79	5277.94	5778.65	6674.29	5856.23	6765.97
Full Back/Left Arm	S9BL-0	0-	00	3634.76	3874.54	4008.53	4269.46	4445.79	5277.94	5778.65	6674.29	5856.23	6765.97
Low Screen*													
Full Back/Right Arm	S9BR-L	2-	00	\$4654.52	\$4894.30	\$5028.29	\$5289.22	\$5465.55	\$6297.70	\$6798.41	\$7694.05	\$6875.99	\$7785.73
Full Back/Left Arm	S9BL-L	2-	00	4654.52	4894.30	5028.29	5289.22	5465.55	6297.70	6798.41	7694.05	6875.99	7785.73
High Screen*													
Full Back/Right Arm	S9BR-H	2-	00	\$4654.52	\$4894.30	\$5028.29	\$5289.22	\$5465.55	\$6297.70	\$6798.41	\$7694.05	\$6875.99	\$7785.73
Full Back/Left Arm	S9BL-H	2-	00	4654.52	4894.30	5028.29	5289.22	5465.55	6297.70	6798.41	7694.05	6875.99	7785.73

*Pricing shown for Low and High Screen reflects screen Grade A pricing. Reference chart for upcharge amounts for higher grade pricing.

The following option requires modification of the product number.

Stain repellent
(not applicable to screens)

To specify, add **P** to the end of the product number; **Example:** S9BB-020-100HP (Seat only add **\$42.32** list, Seat/back add **\$77.58** list, Seat/back/arm add **\$112.83** list)

Description	A	B	C	D	E	F	G	H
Low Screen 30" x 36"	N/A	\$239.78	\$373.78	\$634.70	\$811.02	\$1643.19	\$2143.89	\$3039.53
High Screen 30" x 36"	N/A	\$239.78	\$373.78	\$634.70	\$811.02	\$1643.19	\$2143.89	\$3039.53

This page intentionally blank

Two-Seat Collaborative Sofa*

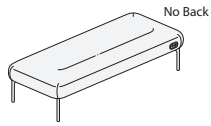

S9C0-0

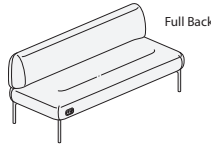

S9CB-0

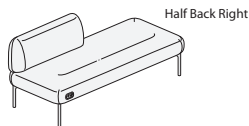

S9CH-0

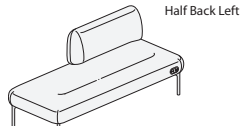

S9CZ-0

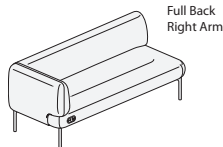

S9CR-0

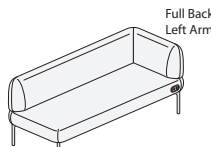

S9CL-0

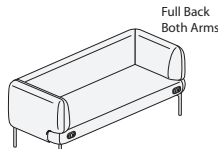

S9C2-0

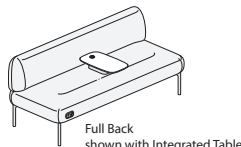

S9CB-0

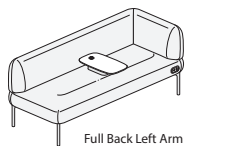

S9CL-0

Dimensions

- *SH: 17.3"(439mm)
- H: 30.5"(775mm)
- No Screen 42"(1067mm)
- Low Screen 54"(1372mm)
- High Screen 54"(1372mm)
- D: 30"(762mm)
- No Screen 32"(813mm)
- With Screen 32"(813mm)
- W: 72"(1829mm)
- SW: 63"(1600mm)
- With One Arm 54"(1372mm)
- With Two Arms 72"(1829mm)
- Without Arms 72"(1829mm)
- *SD: 21.125"(537mm)
- With Back 30"(762mm)
- Without Back 30"(762mm)

* All measurements taken with the BIFMA chair measuring device.

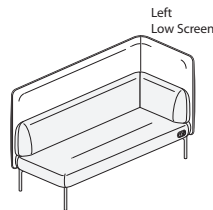

S9CL-L

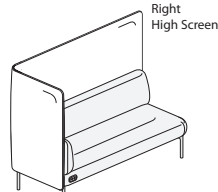

S9CR-H

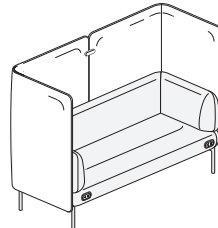

S9C2-H

Features

- Includes: Two-seat sofa on four legs. Sofa can be specified with a half-back, full-back, arms, low or high screens, integrated table and embedded power.
- Optional Low or High Screen available on sofa with full back and right or left-hand arm or both right and left-hand arm. Screen attaches to arm and back. Unit with right arm will have a 30"(762mm)D x 72"(1829mm)W right-hand screen. Sofa with two arms will have two 30"(762mm)D x 36"(914mm)W screens connected with a screen alignment clip.
- Embedded Power available in two options:
 - Power - Two Power Receptacles (NEMA-5-15R) per location)
 - Power + USB - One Power Receptacle (NEMA-5-15R) and two stacked USB 2.0 ports (2A of charging power[5 volts] per USB outlet).
- Power is embedded on seat front on left or right-hand side, or both. When ordering power on both sides the power option will be the same.
- Power housing available in supplier Black or White and has a 10'(3048mm) black cord.
- Integrated table option available on Two-Seat Collaborative Sofas with half-back or full-back.
- Integrated table is 0.75"(19mm) thick and 20"(508mm)D x 11"(279mm)W mounted on a 3.5"(89mm)H stanchion.
- Legs are painted cast aluminum.
- Glides - Black plastic or felt with 0.5"(13mm) leveling adjustment.
- COM yardage/COL square footage:
 - Seat only: 2.75/46.5
 - Seat/half-back: 4.0/70
 - Seat/full-back: 5.0/86
 - Seat/full-back/one arm: 5.75/100
 - Seat/full-back/two arms: 6.5/112.5
 - Screen 30" x 72" Low: 6.25/N/A High: 6.5/N/A
 - Screen 30" x 36" Low: 4.0/N/A High: 4.25/N/A (per screen - there are two screens on this unit.)

Specification Tips

- Gangs on open seat depth with separately specified Cabana seating or tables with or without a screen. Use separately specified Ganging Bracket or Ganging Kit.
- Cannot gang on arm, back or screen locations due to interference. For options see Specification Guide.
- Sofa and screen fabric are applied railroaded.
- Linear or patterned fabric not recommended due to the way material is applied.
- Seat and Screen may be specified with different materials. To specify, select seat material grade. Next, select screen material and add appropriate upcharge (see chart).
- When ordering with screens please note the change in Number:
 - No Screen S9C_0
 - Low Screen S9C_L
 - High Screen S9C_H
- Embedded Power is factory installed and cannot be field installed. Power type can be field modified with service parts.
- **For use with 120 volt 60 hertz electrical system only.**
- Place powered seating within 4'(1219mm) of power source. Power components each have a 10'(3048mm) cord routed to a corresponding opening at rear of seating unit.
- Integrated Table is factory installed. The table position is fixed and cannot be field modified.
- The Integrated Table is designed to work with separately specified, field installed, Bezel Utility Module EURT-00_ __. Table stanchion allows cord management through the seat. Bezel Utility Modules ship standard with 6'(1829mm) or 12'(3658mm) cord lengths.

Specification Tips (cont'd)

- The following separately specified items are designed to work with Cabana screens. It is recommended to use these items on High Screens or placed over a table to prevent interference with user.
 - Shelf S9SH-0
 - Coat Hook HOCH-0000
- See Specification Guide for Application Details.
- Powered applications may require approval of local authority having jurisdiction (AHJ); ensure compliance before placing orders or installing.

To Order, Specify:

- 1) Product number, including:

1 Seat Upholstery Type:

- 1 Leather
- 2 Fabric

2 Power Option:

- 0 None

Power

- 1 Right Power - Black, add **\$324.41** to list
- A Right Power - White, add **\$324.41** to list
- 2 Left Power - Black, add **\$324.41** to list
- B Left Power - White, add **\$324.41** to list
- 3 Right + Left Power - Black, add **\$648.81** to list
- C Right + Left Power - White, add **\$648.81** to list

Power + USB

- 4 Right Power + USB - Black, add **\$409.03** to list
- D Right Power + USB - White, add **\$409.03** to list
- 5 Left Power + USB - Black, add **\$409.03** to list
- E Left Power + USB - White, add **\$409.03** to list
- 6 Right + Left Power + USB - Black, add **\$818.07** to list
- F Right + Left Power + USB - White, add **\$818.07** to list

3 Glide Option:

- H Plastic Glide
- K Felt Glide

- 2) Seat, back and arm material.
- 3) Screen material (if applicable). See chart (page 19) for upcharge.
- 4) Trim color.
- 5) Table finish/color (if applicable).

*This product may be subject to supplemental freight charges.

Two-Seat Collaborative Sofa

Description	Number			Seat, Back & Arms Fabric Grade								Leather Grade A	Leather Grade B
	①	②	③	A	B	C	D	E	F	G	H		
No Screen - No Integrated Table													
No Back	S9C0-0	0-	00	\$2964.78	\$3112.89	\$3197.50	\$ 3359.72	\$ 3472.54	\$ 3994.42	\$ 4304.71	\$ 4868.89	\$ 4410.51	\$ 4981.74
Half Back - Right	S9CH-0	0-	00	3911.20	4136.88	4263.81	4503.58	4672.85	5455.66	5921.10	6760.31	6019.83	6866.12
Half Back - Left	S9CZ-0	0-	00	3911.20	4136.88	4263.81	4503.58	4672.85	5455.66	5921.10	6760.31	6019.83	6866.12
Full Back	S9CB-0	0-	00	4227.14	4530.40	4692.58	5016.99	5242.67	6286.40	6921.11	8028.32	6970.48	8105.88
Full Back/Right Arm	S9CR-0	0-	00	4720.80	5080.47	5277.94	5665.79	5940.84	7189.09	7936.62	9283.63	7993.05	9354.15
Full Back/Left Arm	S9CL-0	0-	00	4720.80	5080.47	5277.94	5665.79	5940.84	7189.09	7936.62	9283.63	7993.05	9354.15
Full Back/Both Arms	S9C2-0	0-	00	5214.46	5637.60	5870.33	6321.67	6639.02	8091.79	8966.26	10531.86	9163.73	10806.91
No Screen - Integrated Table Painted MDF													
Half Back - Right	S9CH-0	0-	P0	\$4496.53	\$4722.21	\$4849.14	\$ 5088.91	\$ 5258.18	\$ 6040.99	\$ 6506.43	\$ 7345.64	\$ 6605.16	\$ 7451.45
Half Back - Left	S9CZ-0	0-	P0	4496.53	4722.21	4849.14	5088.91	5258.18	6040.99	6506.43	7345.64	6605.16	7451.45
Full Back	S9CB-0	0-	P0	4812.47	5115.73	5277.91	5602.32	5828.00	6871.73	7506.44	8613.65	7555.81	8691.21
Full Back/Right Arm	S9CR-0	0-	P0	5306.13	5665.80	5863.27	6251.12	6526.17	7774.42	8521.95	9868.96	8578.38	9939.48
Full Back/Left Arm	S9CL-0	0-	P0	5306.13	5665.80	5863.27	6251.12	6526.17	7774.42	8521.95	9868.96	8578.38	9939.48
Full Back/Both Arms	S9C2-0	0-	P0	5799.79	6222.93	6455.66	6907.00	7224.35	8677.12	9551.59	11117.19	9749.06	11392.24
No Screen - Integrated Table Plank White Oak													
Half Back - Right	S9CH-0	0-	WO	\$5878.80	\$6104.48	\$6231.41	\$ 6471.18	\$ 6640.45	\$ 7423.26	\$ 7888.70	\$ 8727.91	\$ 7987.43	\$ 8833.72
Half Back - Left	S9CZ-0	0-	WO	5878.80	6104.48	6231.41	6471.18	6640.45	7423.26	7888.70	8727.91	7987.43	8833.72
Full Back	S9CB-0	0-	WO	6194.74	6498.00	6660.18	6984.59	7210.27	8254.00	8888.71	9995.92	8938.08	10073.48
Full Back/Right Arm	S9CR-0	0-	WO	6688.40	7048.07	7245.54	7633.39	7908.44	9156.69	9904.22	11251.23	9960.65	11321.75
Full Back/Left Arm	S9CL-0	0-	WO	6688.40	7048.07	7245.54	7633.39	7908.44	9156.69	9904.22	11251.23	9960.65	11321.75
Full Back/Both Arms	S9C2-0	0-	WO	7182.06	7605.20	7837.93	8289.27	8606.62	10059.39	10933.86	12499.46	11131.33	12774.51
No Screen - Integrated Table Plank Walnut													
Half Back - Right	S9CH-0	0-	WO	\$5998.66	\$6224.34	\$6351.27	\$ 6591.04	\$ 6760.31	\$ 7543.12	\$ 8008.56	\$ 8847.77	\$ 8107.29	\$ 8953.58
Half Back - Left	S9CZ-0	0-	WO	5998.66	6224.34	6351.27	6591.04	6760.31	7543.12	8008.56	8847.77	8107.29	8953.58
Full Back	S9CB-0	0-	WO	6314.60	6617.86	6780.04	7104.45	7330.13	8373.86	9008.57	10115.78	9057.94	10193.34
Full Back/Right Arm	S9CR-0	0-	WO	6808.26	7167.93	7365.40	7753.25	8028.30	9276.55	10024.08	11371.09	10080.51	11441.61
Full Back/Left Arm	S9CL-0	0-	WO	6808.26	7167.93	7365.40	7753.25	8028.30	9276.55	10024.08	11371.09	10080.51	11441.61
Full Back/Both Arms	S9C2-0	0-	WO	7301.92	7725.06	7957.79	8409.13	8726.48	10179.25	11053.72	12619.32	11251.19	12894.37
Low Screen* - No Integrated Table													
Full Back/Right Arm	S9CR-L	2-	00	\$6658.76	\$7018.43	\$7215.90	\$ 7603.75	\$ 7878.80	\$ 9127.05	\$ 9874.58	\$11221.59	\$ 9931.01	\$11292.11
Full Back/Left Arm	S9CL-L	2-	00	6658.76	7018.43	7215.90	7603.75	7878.80	9127.05	9874.58	11221.59	9931.01	11292.11
Full Back/Both Arms	S9C2-L	2-	00	7253.98	7677.12	7909.85	8361.19	8678.54	10131.31	11005.78	12571.38	11203.25	12846.43
Low Screen* - Integrated Table Painted MDF													
Full Back/Right Arm	S9CR-L	2-	P0	\$7244.09	\$7603.76	\$7801.23	\$ 8189.08	\$ 8464.13	\$ 9712.38	\$10459.91	\$11806.92	\$10516.34	\$11877.44
Full Back/Left Arm	S9CL-L	2-	P0	7244.09	7603.76	7801.23	8189.08	8464.13	9712.38	10459.91	11806.92	10516.34	11877.44
Full Back/Both Arms	S9C2-L	2-	P0	7839.31	8262.45	8495.18	8946.52	9263.87	10716.64	11591.11	13156.71	11788.58	13431.76
Low Screen* - Integrated Table Plank White Oak													
Full Back/Right Arm	S9CR-L	2-	WO	\$8626.36	\$8986.03	\$9183.50	\$ 9571.35	\$ 9846.40	\$11094.65	\$11842.18	\$13189.19	\$11898.61	\$13259.71
Full Back/Left Arm	S9CL-L	2-	WO	8626.36	8986.03	9183.50	9571.35	9846.40	11094.65	11842.18	13189.19	11898.61	13259.71
Full Back/Both Arms	S9C2-L	2-	WO	9221.58	9644.72	9877.45	10328.79	10646.14	12098.91	12973.38	14538.98	13170.85	14814.03
Low Screen* - Integrated Table Plank Walnut													
Full Back/Right Arm	S9CR-L	2-	WO	\$8746.22	\$9105.89	\$9303.36	\$ 9691.21	\$ 9966.26	\$11214.51	\$11962.04	\$13309.05	\$12018.47	\$13379.57
Full Back/Left Arm	S9CL-L	2-	WO	8746.22	9105.89	9303.36	9691.21	9966.26	11214.51	11962.04	13309.05	12018.47	13379.57
Full Back/Both Arms	S9C2-L	2-	WO	9341.44	9764.58	9997.31	10448.65	10766.00	12218.77	13093.24	14658.84	13290.71	14933.89
High Screen* - No Integrated Table													
Full Back/Right Arm	S9CR-H	2-	00	\$6658.76	\$7018.43	\$7215.90	\$ 7603.75	\$ 7878.80	\$ 9127.05	\$ 9874.58	\$11221.59	\$ 9931.01	\$11292.11
Full Back/Left Arm	S9CL-H	2-	00	6658.76	7018.43	7215.90	7603.75	7878.80	9127.05	9874.58	11221.59	9931.01	11292.11
Full Back/Both Arms	S9C2-H	2-	00	7253.98	7677.12	7909.85	8361.19	8678.54	10131.31	11005.78	12571.38	11203.25	12846.43

*Pricing shown for Low and High Screen reflects screen Grade A pricing. Reference chart for upcharge amounts for higher grade pricing.

Two-Seat Collaborative Sofa

Description	Number			Seat, Back & Arms Fabric Grade								Leather Grade A	Leather Grade B
	①	②	③	A	B	C	D	E	F	G	H		
High Screen* - Integrated Table Painted MDF													
Full Back/Right Arm	S9CR-H	2-	P0	\$7244.09	\$7603.76	\$7801.23	\$ 8189.08	\$ 8464.13	\$ 9712.38	\$10459.91	\$11806.92	\$10516.34	\$11877.44
Full Back/Left Arm	S9CL-H	2-	P0	7244.09	7603.76	7801.23	8189.08	8464.13	9712.38	10459.91	11806.92	10516.34	11877.44
Full Back/Both Arms	S9C2-H	2-	P0	7839.31	8262.45	8495.18	8946.52	9263.87	10716.64	11591.11	13156.71	11788.58	13431.76
High Screen* - Integrated Table Plank White Oak													
Full Back/Right Arm	S9CR-H	2-	W0	\$8626.36	\$8986.03	\$9183.50	\$ 9571.35	\$ 9846.40	\$11094.65	\$11842.18	\$13189.19	\$11898.61	\$13259.71
Full Back/Left Arm	S9CL-H	2-	W0	8626.36	8986.03	9183.50	9571.35	9846.40	11094.65	11842.18	13189.19	11898.61	13259.71
Full Back/Both Arms	S9C2-H	2-	W0	9221.58	9644.72	9877.45	10328.79	10646.14	12098.91	12973.38	14538.98	13170.85	14814.03
High Screen* - Integrated Table Plank Walnut													
Full Back/Right Arm	S9CR-H	2-	W0	\$8746.22	\$9105.89	\$9303.36	\$ 9691.21	\$ 9966.26	\$11214.51	\$11962.04	\$13309.05	\$12018.47	\$13379.57
Full Back/Left Arm	S9CL-H	2-	W0	8746.22	9105.89	9303.36	9691.21	9966.26	11214.51	11962.04	13309.05	12018.47	13379.57
Full Back/Both Arms	S9C2-H	2-	W0	9341.44	9764.58	9997.31	10448.65	10766.00	12218.77	13093.24	14658.84	13290.71	14933.89

*Pricing shown for Low and High Screen reflects screen Grade A pricing. Reference chart for upcharge amounts for higher grade pricing.

The following option requires modification of the product number.

Stain repellent (not applicable to screens) To specify, add **P** to the end of the product number; **Example:** S9CR-020-0W0HP (Seat only add **\$70.52** list, Seat/half-back add **\$105.79** list, Seat/full-back add **\$141.05** list, Seat/back/one arm add **\$169.25** list, Seat/back/two arms add **\$197.46** list)

Description	A	B	C	D	E	F	G	H
Low Screen 30" x 72"	N/A	\$423.14	\$655.87	\$1107.21	\$1424.56	\$2877.33	\$3751.81	\$5218.68
Low Screen (2) 30" x 36"	N/A	\$479.56	\$747.54	\$1269.41	\$1622.02	\$3286.35	\$4287.78	\$6079.05
High Screen 30" x 72"	N/A	\$423.14	\$655.87	\$1107.21	\$1424.56	\$2877.33	\$3751.81	\$5218.68
High Screen (2) 30" x 36"	N/A	\$479.56	\$747.54	\$1269.41	\$1622.02	\$3286.35	\$4287.78	\$6079.05

Chaise Lounge*

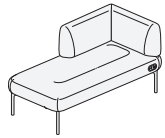

S9DT-0

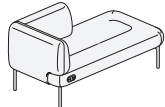

S9DC-0

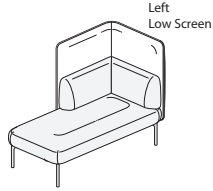

S9DT-L

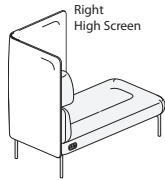

S9DC-H

Dimensions

- *SH: 17.3"(439mm)
- H: 30.5"(775mm)
- No Screen
42"(1067mm)
- Low Screen
54"(1372mm)
- High Screen
D: 30"(762mm)
- No Screen
32"(813mm)
- With Screen
W: 60"(1524mm)
- SW: 51"(1295mm)
- *SD: 21.125"(537mm)-
30"(762mm)

* All measurements taken with the BIFMA chair measuring device.

Features

- Includes: Chaise sofa with right or left back and arm and four legs.
- Optional Low or High Screen available. Screen attaches to arm and back. Unit with right arm and back will have a right-hand 30"(762mm)D x 30"(762mm)W screen.
- Embedded Power available in two options:
–Power - Two Power Receptacles (NEMA-5-15R) per location
–Power + USB - One Power Receptacle (NEMA-5-15R) and two stacked USB 2.0 ports (2A of charging power[5 volts] per USB outlet).
- Power is embedded on seat front on left or right-hand side, or both. When ordering power on both sides the power option will be the same.
- Power housing available in supplier Black or White with 10'(3048mm) black cord.
- Legs - painted cast aluminum.
- Glides - Black plastic or felt with 0.5"(13mm) leveling adjustment.
- COM yardage/COL square footage:
Chaise: 4.25/72.25
Screen Low: 3.75/N/A High: 4.0/N/A

Specification Tips

- Gangs on open width end with separately specified Cabana seating or tables with or without a screen. Use separately specified Ganging Bracket or Ganging Kit.
- Cannot gang on arm, back or screen locations due to interference. For options see Specification Guide.
- Chaise and screen fabric are applied railroaded.
- Linear or patterned fabric not recommended due to the way material is applied.
- Seat and Screen may be specified with different materials. To specify, select seat material grade. Next, select screen material and add appropriate upcharge.(see chart).
- When ordering with screens please note the change in Number:
–No Screen S9D_**0**
–Low Screen S9D_**L**
–High Screen S9D_**H**
- Embedded Power is factory installed and cannot be field installed. Power type can be field modified with service parts.
- **For use with 120 volt 60 hertz electrical system only.**
- Place powered seating within 4'(1219mm) of power source. Power components each have a 10'(3048mm) cord routed to a corresponding opening at rear of seating unit.
- The following separately specified items are designed to work with Cabana screens. It is recommended to use these items on High Screens or placed over a table to prevent interference with user.
–Shelf S9SH-0
–Coat Hook HOCH-0000
- See Specification Guide for Application Details.
- Powered applications may require approval of local authority having jurisdiction (AHJ); ensure compliance before placing orders or installing.

To Order, Specify:

1) Product number, including:

1 Seat Upholstery Type:

- 1 Leather
- 2 Fabric

2 Power Option:

0 None

Power

1 Right Power - Black, add \$324.41 to list

A Right Power - White, add \$324.41 to list

2 Left Power - Black, add \$324.41 to list

B Left Power - White, add \$324.41 to list

3 Right + Left Power - Black, add \$648.81 to list

C Right + Left Power - White, add \$648.81 to list

Power + USB

4 Right Power + USB - Black, add \$409.03 to list

D Right Power + USB - White, add \$409.03 to list

5 Left Power + USB - Black, add \$409.03 to list

E Left Power + USB - White, add \$409.03 to list

6 Right + Left Power + USB - Black, add \$818.07 to list

F Right +Left Power + USB - White, add \$818.07 to list

3 Glide Option:

- H Plastic Glide
- K Felt Glide

2) Seat, back and arm material.

3) Screen material (if applicable). See chart (next page) for upcharge.

4) Leg color.

*This product may be subject to supplemental freight charges.

Chaise Lounge

Description	Number			Seat, Back & Arms Fabric Grade								Leather Grade A	Leather Grade B
	①	②	③	A	B	C	D	E	F	G	H		
No Screen													
Right Arm + Back	S9DC-0	0-	00	\$3737.73	\$3991.61	\$4132.67	\$4407.71	\$4598.10	\$5486.69	\$6015.62	\$6967.67	\$6114.35	\$7073.45
Left Arm + Back	S9DT-0	0-	00	3737.73	3991.61	4132.67	4407.71	4598.10	5486.69	6015.62	6967.67	6114.35	7073.45
Low Screen*													
Right Arm + Back	S9DC-L	2-	00	\$4757.49	\$5011.37	\$5152.43	\$5427.47	\$5617.86	\$6506.45	\$7035.38	\$7987.43	\$7134.11	\$8093.21
Left Arm + Back	S9DT-L	2-	00	4757.49	5011.37	5152.43	5427.47	5617.86	6506.45	7035.38	7987.43	7134.11	8093.21
High Screen*													
Right Arm + Back	S9DC-H	2-	00	\$4757.49	\$5011.37	\$5152.43	\$5427.47	\$5617.86	\$6506.45	\$7035.38	\$7987.43	\$7134.11	\$8093.21
Left Arm + Back	S9DT-H	2-	00	4757.49	5011.37	5152.43	5427.47	5617.86	6506.45	7035.38	7987.43	7134.11	8093.21

*Pricing shown for Low and High Screen reflects screen Grade A pricing. Reference chart for upcharge amounts for higher grade pricing.

The following option requires modification of the product number.

Stain repellent To specify, add **P** to the end of the product number; **Example:** S9DC-020-000HP (add **\$119.90** to list)
 (not applicable to screens)

Description	A	B	C	D	E	F	G	H
Low Screen 30" x 36"	N/A	\$239.78	\$373.78	\$634.70	\$811.02	\$1643.19	\$2143.89	\$3039.53
High Screen 30" x 36"	N/A	\$239.78	\$373.78	\$634.70	\$811.02	\$1643.19	\$2143.89	\$3039.53

Tables

Square

Square

Square Table Freestanding

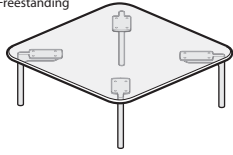

S910

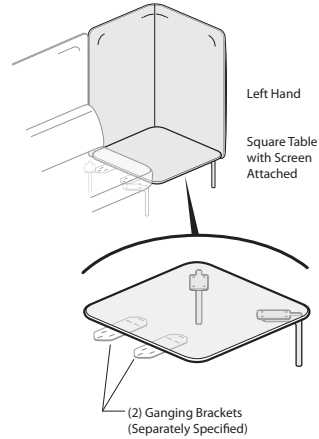

S914

Dimensions

- H: 10"(254mm)
- No Screen
- 42"(1067mm)
- Low Screen
- 54"(1372mm)
- High Screen
- D: 30"(762mm)
- No Screen
- 32"(813mm)
- With Screen
- W: 30"(762mm)
- No Screen
- 32"(813mm)
- With Screen

Features

- Includes 1"(25mm) thick table top and four legs with optional Low or High screen.
- Top available in painted MDF or planked wood in White Oak or Walnut.
- Legs - painted cast aluminum.
- Glides - Black plastic or felt with 0.5"(13mm) leveling adjustment.
- COM yardage: (COL N/A on screens)
- Screen Low: 3.75/N/A High: 4.0/N/A

To Order, Specify:

- 1) Product number, including:

1 Glide Style:

- H** Plastic Glide
- K** Felt Glide

- 2) Surface material/color.
- 3) Screen material (if applicable).
- 4) Leg color.

Specification Tips

- Tables without screens can be used as freestanding or ganged to a Cabana seating unit.
- Tables with screens must be ganged to other Cabana seating using separately specified Ganging Brackets or Ganging Kit. Cannot gang to arm, back or screen locations due to interference. For options see Specification Guide.
- When ganging, table legs may be removed from ganging location.
- Screen material is applied railroaded.
- Linear or patterned fabric not recommended due to the way material is applied.
- Screens are handed and cannot be field modified.
- Product Number changes based on screen height and right or left orientation. Please ensure correct Number is ordered.
- Table can be powered with separately specified and field installed Bezel Utility Module EURT-00 __. Bezel Utility Modules ship standard with 6'(1829mm) or 12'(3658mm) cord lengths.
- Screens are designed to work with separately specified:
 - Shelf S9SH-0
 - Coat Hook HOCH-0000
- See Specification Guide for Application Details.

Description	Number 1	Price	Screen Fabric Grade							
			A	B	C	D	E	F	G	H
No Screen										
Painted MDF	S910-P00-█	\$1911.17	N/A	N/A	N/A	N/A	N/A	N/A	N/A	N/A
Plank White Oak	S910-W00-█	3836.42	N/A	N/A	N/A	N/A	N/A	N/A	N/A	N/A
Plank Walnut	S910-W00-█	4732.07	N/A	N/A	N/A	N/A	N/A	N/A	N/A	N/A
Low Screen - Right Hand										
Painted MDF	S911-P02-█	N/A	\$2930.93	\$3170.71	\$3304.70	\$3565.63	\$3741.96	\$4574.11	\$5074.82	\$5970.46
Plank White Oak	S911-W02-█	N/A	4856.18	5095.96	5229.95	5490.88	5667.21	6499.36	7000.07	7895.71
Plank Walnut	S911-W02-█	N/A	5751.83	5991.61	6125.60	6386.53	6562.86	7395.01	7895.72	8791.36
Low Screen - Left Hand										
Painted MDF	S913-P02-█	N/A	\$2930.93	\$3170.71	\$3304.70	\$3565.63	\$3741.96	\$4574.11	\$5074.82	\$5970.46
Plank White Oak	S913-W02-█	N/A	4856.18	5095.96	5229.95	5490.88	5667.21	6499.36	7000.07	7895.71
Plank Walnut	S913-W02-█	N/A	5751.83	5991.61	6125.60	6386.53	6562.86	7395.01	7895.72	8791.36
High Screen - Right Hand										
Painted MDF	S912-P02-█	N/A	\$2930.93	\$3170.71	\$3304.70	\$3565.63	\$3741.96	\$4574.11	\$5074.82	\$5970.46
Plank White Oak	S912-W02-█	N/A	4856.18	5095.96	5229.95	5490.88	5667.21	6499.36	7000.07	7895.71
Plank Walnut	S912-W02-█	N/A	5751.83	5991.61	6125.60	6386.53	6562.86	7395.01	7895.72	8791.36
High Screen - Left Hand										
Painted MDF	S914-P02-█	N/A	\$2930.93	\$3170.71	\$3304.70	\$3565.63	\$3741.96	\$4574.11	\$5074.82	\$5970.46
Plank White Oak	S914-W02-█	N/A	4856.18	5095.96	5229.95	5490.88	5667.21	6499.36	7000.07	7895.71
Plank Walnut	S914-W02-█	N/A	5751.83	5991.61	6125.60	6386.53	6562.86	7395.01	7895.72	8791.36

This page intentionally blank

Tables

Square Tiered

Square Tiered

Square Tiered
Freestanding

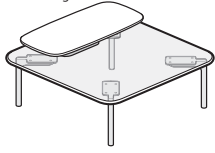

S920

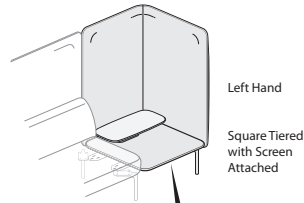

S924

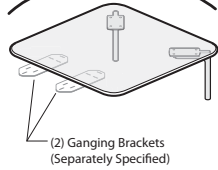

Dimensions

- H: 10"(254mm)
- No Screen
- 42"(1067mm)
- Low Screen
- 54"(1372mm)
- High Screen
- D: 30"(762mm)
- No Screen
- 32"(813mm)
- With Screen
- W: 30"(762mm)
- No Screen
- 32"(813mm)
- With Screen

Features

- Includes 1"(25mm) thick square table top, second tier small rectangular 0.75"(19mm) thick top on stanchion and four legs with optional Low or High screen.
- Lower table surface available in painted MDF or planked wood in White Oak or Walnut.
- Upper surface available in painted MDF or planked wood in White Oak or Walnut. Upper surface material may be different from lower surface.
- Upper surface is 12.25"(311mm)D x 26.5"(673mm)W. Stanchion height is 3.5"(89mm)
- Legs - painted cast aluminum.
- Glides - Black plastic or felt with 0.5"(13mm) leveling adjustment.
- COM yardage: (COL N/A on screens)
Screen Low: 3.75/N/A High: 4.0/N/A

To Order, Specify:

- 1) Product number, including:

1 Glide Style:

- H** Plastic Glide
- K** Felt Glide

- 2) Lower surface material/color.
- 3) Upper surface material/color.
- 4) Screen material (if applicable).
- 5) Trim color.

Specification Tips

- Tables without screens can be used as freestanding or ganged to a Cabana seating unit.
- Tables with screens must be ganged to other Cabana seating using separately specified Ganging Brackets or Ganging Kit. Cannot gang to arm, back or screen locations due to interference. For options see Specification Guide.
- When ganging, table legs may be removed from ganging location.
- Screen material applied railroaded.
- Linear or patterned fabric not recommended due to the way material is applied.
- Screens are handed and cannot be field modified.
- Product Number changes based on screen height and right or left orientation. Please ensure correct Number is ordered.
- Table can be powered with separately specified and field installed Bezel Utility Module EURT-00_ __. Bezel Utility Modules ship standard with 6'(1829mm) or 12'(3658mm) cord lengths.
- The upper tier stanchion mount allows cord management through the table.
- Upper tier stanchion location is fixed and cannot be field modified.
- Screens are designed to work with separately specified:
 - Shelf S9SH-0
 - Coat Hook HOCH-0000
- See Specification Guide for Application Details.

Tables

Square Tiered

Lower Surface	Upper Surface	Number ①	Price	Screen Fabric Grade							
				A	B	C	D	E	F	G	H
No Screen											
Painted MDF	Painted MDF	S920-PP0-■	\$2496.50	N/A	N/A	N/A	N/A	N/A	N/A	N/A	N/A
Painted MDF	Plank White Oak	S920-PW0-■	4111.49	N/A	N/A	N/A	N/A	N/A	N/A	N/A	N/A
Painted MDF	Plank Walnut	S920-PW0-■	4203.17	N/A	N/A	N/A	N/A	N/A	N/A	N/A	N/A
Plain White Oak	Painted MDF	S920-WP0-■	4421.75	N/A	N/A	N/A	N/A	N/A	N/A	N/A	N/A
Plank White Oak	Plank White Oak	S920-WW0-■	6036.74	N/A	N/A	N/A	N/A	N/A	N/A	N/A	N/A
Plank White Oak	Plank Walnut	S920-WW0-■	6128.42	N/A	N/A	N/A	N/A	N/A	N/A	N/A	N/A
Plank Walnut	Painted MDF	S920-WP0-■	5317.40	N/A	N/A	N/A	N/A	N/A	N/A	N/A	N/A
Plank Walnut	Plank White Oak	S920-WW0-■	6932.39	N/A	N/A	N/A	N/A	N/A	N/A	N/A	N/A
Plank Walnut	Plank Walnut	S920-WW0-■	7024.07	N/A	N/A	N/A	N/A	N/A	N/A	N/A	N/A
Low Screen - Right Hand											
Painted MDF	Painted MDF	S921-PP2-■	N/A	\$3516.26	\$3756.04	\$3890.03	\$4150.96	\$4327.29	\$5159.44	\$ 5660.15	\$ 6555.79
Painted MDF	Plank White Oak	S921-PW2-■	N/A	5131.25	5371.03	5505.02	5765.95	5942.28	6774.43	7275.14	8170.78
Painted MDF	Plank Walnut	S921-PW2-■	N/A	5222.93	5462.71	5596.70	5857.63	6033.96	6866.11	7366.82	8262.46
Plank White Oak	Painted MDF	S921-WP2-■	N/A	5441.51	5681.29	5815.28	6076.21	6252.54	7084.69	7585.40	8481.04
Plank White Oak	Plank White Oak	S921-WW2-■	N/A	7056.50	7296.28	7430.27	7691.20	7867.53	8699.68	9200.39	10096.03
Plank White Oak	Plank Walnut	S921-WW2-■	N/A	7148.18	7387.96	7521.95	7782.88	7959.21	8791.36	9292.07	10187.71
Plank Walnut	Painted MDF	S921-WP2-■	N/A	6337.16	6576.94	6710.93	6971.86	7148.19	7980.34	8481.05	9376.69
Plank Walnut	Plank White Oak	S921-WW2-■	N/A	7952.15	8191.93	8325.92	8586.85	8763.18	9595.33	10096.04	10991.68
Plank Walnut	Plank Walnut	S921-WW2-■	N/A	8043.83	8283.61	8417.60	8678.53	8854.86	9687.01	10187.72	11083.36
Low Screen - Left Hand											
Painted MDF	Painted MDF	S923-PP2-■	N/A	\$3516.26	\$3756.04	\$3890.03	\$4150.96	\$4327.29	\$5159.44	\$ 5660.15	\$ 6555.79
Painted MDF	Plank White Oak	S923-PW2-■	N/A	5131.25	5371.03	5505.02	5765.95	5942.28	6774.43	7275.14	8170.78
Painted MDF	Plank Walnut	S923-PW2-■	N/A	5222.93	5462.71	5596.70	5857.63	6033.96	6866.11	7366.82	8262.46
Plank White Oak	Painted MDF	S923-WP2-■	N/A	5441.51	5681.29	5815.28	6076.21	6252.54	7084.69	7585.40	8481.04
Plank White Oak	Plank White Oak	S923-WW2-■	N/A	7056.50	7296.28	7430.27	7691.20	7867.53	8699.68	9200.39	10096.03
Plank White Oak	Plank Walnut	S923-WW2-■	N/A	7148.18	7387.96	7521.95	7782.88	7959.21	8791.36	9292.07	10187.71
Plank Walnut	Painted MDF	S923-WP2-■	N/A	6337.16	6576.94	6710.93	6971.86	7148.19	7980.34	8481.05	9376.69
Plank Walnut	Plank White Oak	S923-WW2-■	N/A	7952.15	8191.93	8325.92	8586.85	8763.18	9595.33	10096.04	10991.68
Plank Walnut	Plank Walnut	S923-WW2-■	N/A	8043.83	8283.61	8417.60	8678.53	8854.86	9687.01	10187.72	11083.36
High Screen - Right Hand											
Painted MDF	Painted MDF	S922-PP2-■	N/A	\$3516.26	\$3756.04	\$3890.03	\$4150.96	\$4327.29	\$5159.44	\$ 5660.15	\$ 6555.79
Painted MDF	Plank White Oak	S922-PW2-■	N/A	5131.25	5371.03	5505.02	5765.95	5942.28	6774.43	7275.14	8170.78
Painted MDF	Plank Walnut	S922-PW2-■	N/A	5222.93	5462.71	5596.70	5857.63	6033.96	6866.11	7366.82	8262.46
Plank White Oak	Painted MDF	S922-WP2-■	N/A	5441.51	5681.29	5815.28	6076.21	6252.54	7084.69	7585.40	8481.04
Plank White Oak	Plank White Oak	S922-WW2-■	N/A	7056.50	7296.28	7430.27	7691.20	7867.53	8699.68	9200.39	10096.03
Plank White Oak	Plank Walnut	S922-WW2-■	N/A	7148.18	7387.96	7521.95	7782.88	7959.21	8791.36	9292.07	10187.71
Plank Walnut	Painted MDF	S922-WP2-■	N/A	6337.16	6576.94	6710.93	6971.86	7148.19	7980.34	8481.05	9376.69
Plank Walnut	Plank White Oak	S922-WW2-■	N/A	7952.15	8191.93	8325.92	8586.85	8763.18	9595.33	10096.04	10991.68
Plank Walnut	Plank Walnut	S922-WW2-■	N/A	8043.83	8283.61	8417.60	8678.53	8854.86	9687.01	10187.72	11083.36
High Screen - Left Hand											
Painted MDF	Painted MDF	S924-PP2-■	N/A	\$3516.26	\$3756.04	\$3890.03	\$4150.96	\$4327.29	\$5159.44	\$ 5660.15	\$ 6555.79
Painted MDF	Plank White Oak	S924-PW2-■	N/A	5131.25	5371.03	5505.02	5765.95	5942.28	6774.43	7275.14	8170.78
Painted MDF	Plank Walnut	S924-PW2-■	N/A	5222.93	5462.71	5596.70	5857.63	6033.96	6866.11	7366.82	8262.46
Plank White Oak	Painted MDF	S924-WP2-■	N/A	5441.51	5681.29	5815.28	6076.21	6252.54	7084.69	7585.40	8481.04
Plank White Oak	Plank White Oak	S924-WW2-■	N/A	7056.50	7296.28	7430.27	7691.20	7867.53	8699.68	9200.39	10096.03
Plank White Oak	Plank Walnut	S924-WW2-■	N/A	7148.18	7387.96	7521.95	7782.88	7959.21	8791.36	9292.07	10187.71
Plank Walnut	Painted MDF	S924-WP2-■	N/A	6337.16	6576.94	6710.93	6971.86	7148.19	7980.34	8481.05	9376.69
Plank Walnut	Plank White Oak	S924-WW2-■	N/A	7952.15	8191.93	8325.92	8586.85	8763.18	9595.33	10096.04	10991.68
Plank Walnut	Plank Walnut	S924-WW2-■	N/A	8043.83	8283.61	8417.60	8678.53	8854.86	9687.01	10187.72	11083.36

Tables

Rectangle

Rectangle

Rectangular Table
Freestanding

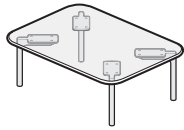

S930



Left Hand

Rectangular Table
with Screen
Attached

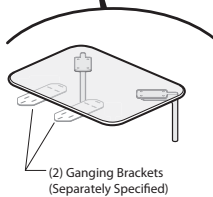

(2) Ganging Brackets
(Separately Specified)

S934

Dimensions

- H: 10"(254mm)
- No Screen
- 42"(1067mm)
- Low Screen
- 54"(1372mm)
- High Screen
- D: 30"(762mm)
- No Screen
- 32"(813mm)
- With Screen
- W: 21"(533mm)
- No Screen
- 23"(584mm)
- With Screen

Features

- Includes 1"(25mm) thick table top and four legs with optional Low or High screen.
- Top available in painted MDF or planked wood in White Oak or Walnut.
- Legs - painted cast aluminum.
- Glides - Black plastic or felt with 0.5"(13mm) leveling adjustment.
- COM yardage: (COL N/A on screens)
Screen Low: 3.25/N/A High: 3.5/N/A

To Order, Specify:

- 1) Product number, including:

1) Glide Style:

- H** Plastic Glide
- K** Felt Glide

- 2) Surface material/color.
- 3) Screen material (if applicable).
- 4) Leg color.

Specification Tips

- Tables without screens can be used as freestanding or ganged to a Cabana seating unit.
- Tables with screens must be ganged to other Cabana seating using separately specified Ganging Brackets or Ganging Kit. Cannot gang to arm, back or screen locations due to interference. For options see Specification Guide.
- When ganging, table legs may be removed from ganging location.
- Screen material is applied railroaded.
- Linear or patterned material not recommended due to the way material is applied.
- Screens are handed and cannot be field modified.
- Product Number changes based on screen height and right or left orientation. Please ensure correct Number is ordered.
- Table can be powered with separately specified and field installed Bezel Utility Module EURT-00 __. Bezel Utility Modules ship standard with 6'(1829mm) or 12'(3658mm) cord lengths.
- Screens are designed to work with separately specified:
 - Shelf S9SH-0
 - Coat Hook HOCH-0000
- See Specification Guide for Application Details.

Description	Number ¹	Price	Screen Fabric Grade							
			A	B	C	D	E	F	G	H
No Screen										
Painted MDF	S930-P00-	\$1410.45	N/A	N/A	N/A	N/A	N/A	N/A	N/A	N/A
Plank White Oak	S930-W00-	3229.94	N/A	N/A	N/A	N/A	N/A	N/A	N/A	N/A
Plank Walnut	S930-W00-	3822.32	N/A	N/A	N/A	N/A	N/A	N/A	N/A	N/A
Low Screen - Right Hand										
Painted MDF	S931-P02-	N/A	\$2325.14	\$2536.70	\$2649.55	\$2875.22	\$3037.42	\$3763.80	\$4201.05	\$4983.86
Plank White Oak	S931-W02-	N/A	4144.63	4356.19	4469.04	4694.71	4856.91	5583.29	6020.54	6803.35
Plank Walnut	S931-W02-	N/A	4737.01	4948.57	5061.42	5287.09	5449.29	6175.67	6612.92	7395.73
Low Screen - Left Hand										
Painted MDF	S933-P02-	N/A	\$2325.14	\$2536.70	\$2649.55	\$2875.22	\$3037.42	\$3763.80	\$4201.05	\$4983.86
Plank White Oak	S933-W02-	N/A	4144.63	4356.19	4469.04	4694.71	4856.91	5583.29	6020.54	6803.35
Plank Walnut	S933-W02-	N/A	4737.01	4948.57	5061.42	5287.09	5449.29	6175.67	6612.92	7395.73
High Screen - Right Hand										
Painted MDF	S932-P02-	N/A	\$2325.14	\$2536.70	\$2649.55	\$2875.22	\$3037.42	\$3763.80	\$4201.05	\$4983.86
Plank White Oak	S932-W02-	N/A	4144.63	4356.19	4469.04	4694.71	4856.91	5583.29	6020.54	6803.35
Plank Walnut	S932-W02-	N/A	4737.01	4948.57	5061.42	5287.09	5449.29	6175.67	6612.92	7395.73
High Screen - Left Hand										
Painted MDF	S934-P02-	N/A	\$2325.14	\$2536.70	\$2649.55	\$2875.22	\$3037.42	\$3763.80	\$4201.05	\$4983.86
Plank White Oak	S934-W02-	N/A	4144.63	4356.19	4469.04	4694.71	4856.91	5583.29	6020.54	6803.35
Plank Walnut	S934-W02-	N/A	4737.01	4948.57	5061.42	5287.09	5449.29	6175.67	6612.92	7395.73

This page intentionally blank

Tables

Rectangle Tiered

Rectangle Tiered

Rectangular Table
Freestanding

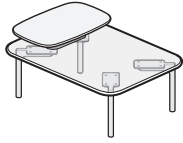

S940

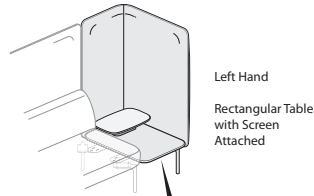

Left Hand
Rectangular Table
with Screen
Attached

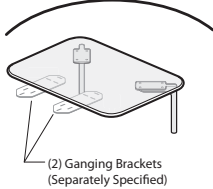

(2) Ganging Brackets
(Separately Specified)

S944

Dimensions

- H: 10"(254mm)
- No Screen
- 42"(1067mm)
- Low Screen
- 54"(1372mm)
- High Screen
- D: 30"(762mm)
- No Screen
- 32"(813mm)
- With Screen
- W: 21"(533mm)
- No Screen
- 23"(584mm)
- With Screen

Features

- Includes 1"(25mm) thick rectangular table top, second tier small rectangular 0.75"(19mm) thick top on stanchion and four legs with optional Low or High screen.
- Lower table surface available in painted MDF or planked wood in White Oak or Walnut.
- Upper surface available in painted MDF or planked wood in White Oak or Walnut. Upper surface material may be different from lower surface.
- Upper surface is 12.25"(311mm)D x 18.5"(673mm)W. Stanchion height is 3.5"(89mm).
- Legs - painted cast aluminum.
- Glides - Black plastic or felt with 0.5"(13mm) leveling adjustment.
- COM yardage: (COL N/A on screens)
Screen Low: 3.25/N/A High: 3.5/N/A

To Order, Specify:

- 1) Product number, including:

1 Glide Style:

- H** Plastic Glide
- K** Felt Glide

- 2) Lower surface material/color.
- 3) Upper surface material/color.
- 4) Screen material (if applicable).
- 5) Trim color.

Specification Tips

- Tables without screens can be used as freestanding or ganged to a Cabana seating unit.
- Tables with screens must be ganged to other Cabana seating using separately specified Ganging Brackets or Ganging Kit. Cannot gang to arm, back or screen locations due to interference. For options see Specification Guide.
- When ganging, table legs may be removed from ganging location.
- Screen material applied railroaded.
- Linear or patterned material not recommended due to the way material is applied.
- Screens are handed and cannot be field modified.
- Product Number changes based on screen height and right or left orientation. Please ensure correct Number is ordered.
- Table can be powered with separately specified and field installed Bezel Utility Module EURT-00 ___. Bezel Utility Modules ship standard with 6'(1829mm) or 12'(3658mm) cord lengths.
- The upper tier stanchion mount allows cord management through the table.
- Upper tier stanchion is factory installed and cannot be field modified.
- Screens are designed to work with separately specified:
 - Shelf S9SH-0
 - Coat Hook HOCH-0000
- See Specification Guide for Application Details.

Tables

Rectangle Tiered

Lower Surface	Upper Surface	Number ^①	Price	Screen Fabric Grade								
				A	B	C	D	E	F	G	H	
No Screen												
Painted MDF	Painted MDF	S940-PP0-■	\$1918.21	N/A	N/A	N/A	N/A	N/A	N/A	N/A	N/A	N/A
Painted MDF	Plank White Oak	S940-PW0-■	3737.70	N/A	N/A	N/A	N/A	N/A	N/A	N/A	N/A	N/A
Painted MDF	Plank Walnut	S940-PW0-■	3878.74	N/A	N/A	N/A	N/A	N/A	N/A	N/A	N/A	N/A
Plain White Oak	Painted MDF	S940-WP0-■	3737.70	N/A	N/A	N/A	N/A	N/A	N/A	N/A	N/A	N/A
Plank White Oak	Plank White Oak	S940-WW0-■	5557.19	N/A	N/A	N/A	N/A	N/A	N/A	N/A	N/A	N/A
Plank White Oak	Plank Walnut	S940-WW0-■	5698.23	N/A	N/A	N/A	N/A	N/A	N/A	N/A	N/A	N/A
Plank Walnut	Painted MDF	S940-WP0-■	4330.08	N/A	N/A	N/A	N/A	N/A	N/A	N/A	N/A	N/A
Plank Walnut	Plank White Oak	S940-WW0-■	6149.57	N/A	N/A	N/A	N/A	N/A	N/A	N/A	N/A	N/A
Plank Walnut	Plank Walnut	S940-WW0-■	6290.61	N/A	N/A	N/A	N/A	N/A	N/A	N/A	N/A	N/A
Low Screen - Right Hand												
Painted MDF	Painted MDF	S941-PP2-■	N/A	\$2832.90	\$3044.46	\$3157.31	\$3382.98	\$3545.18	\$4271.56	\$4708.81	\$5491.62	
Painted MDF	Plank White Oak	S941-PW2-■	N/A	4652.39	4863.95	4976.80	5202.47	5364.67	6091.05	6528.30	7311.11	
Painted MDF	Plank Walnut	S941-PW2-■	N/A	4793.43	5004.99	5117.84	5343.51	5505.71	6232.09	6669.34	7452.15	
Plank White Oak	Painted MDF	S941-WP2-■	N/A	4652.39	4863.95	4976.80	5202.47	5364.67	6091.05	6528.30	7311.11	
Plank White Oak	Plank White Oak	S941-WW2-■	N/A	6471.88	6683.44	6796.29	7021.96	7184.16	7910.54	8347.79	9130.60	
Plank White Oak	Plank Walnut	S941-WW2-■	N/A	6612.92	6824.48	6937.33	7163.00	7325.20	8051.58	8488.83	9271.64	
Plank Walnut	Painted MDF	S941-WP2-■	N/A	5244.77	5456.33	5569.18	5794.85	5957.05	6683.43	7120.68	7903.49	
Plank Walnut	Plank White Oak	S941-WW2-■	N/A	7064.26	7275.82	7388.67	7614.34	7776.54	8502.92	8940.17	9722.98	
Plank Walnut	Plank Walnut	S941-WW2-■	N/A	7205.30	7416.86	7529.71	7755.38	7917.58	8643.96	9081.21	9864.02	
Low Screen - Left Hand												
Painted MDF	Painted MDF	S943-PP2-■	N/A	\$2832.90	\$3044.46	\$3157.31	\$3382.98	\$3545.18	\$4271.56	\$4708.81	\$5491.62	
Painted MDF	Plank White Oak	S943-PW2-■	N/A	4652.39	4863.95	4976.80	5202.47	5364.67	6091.05	6528.30	7311.11	
Painted MDF	Plank Walnut	S943-PW2-■	N/A	4793.43	5004.99	5117.84	5343.51	5505.71	6232.09	6669.34	7452.15	
Plank White Oak	Painted MDF	S943-WP2-■	N/A	4652.39	4863.95	4976.80	5202.47	5364.67	6091.05	6528.30	7311.11	
Plank White Oak	Plank White Oak	S943-WW2-■	N/A	6471.88	6683.44	6796.29	7021.96	7184.16	7910.54	8347.79	9130.60	
Plank White Oak	Plank Walnut	S943-WW2-■	N/A	6612.92	6824.48	6937.33	7163.00	7325.20	8051.58	8488.83	9271.64	
Plank Walnut	Painted MDF	S943-WP2-■	N/A	5244.77	5456.33	5569.18	5794.85	5957.05	6683.43	7120.68	7903.49	
Plank Walnut	Plank White Oak	S943-WW2-■	N/A	7064.26	7275.82	7388.67	7614.34	7776.54	8502.92	8940.17	9722.98	
Plank Walnut	Plank Walnut	S943-WW2-■	N/A	7205.30	7416.86	7529.71	7755.38	7917.58	8643.96	9081.21	9864.02	
High Screen - Right Hand												
Painted MDF	Painted MDF	S942-PP2-■	N/A	\$2832.90	\$3044.46	\$3157.31	\$3382.98	\$3545.18	\$4271.56	\$4708.81	\$5491.62	
Painted MDF	Plank White Oak	S942-PW2-■	N/A	4652.39	4863.95	4976.80	5202.47	5364.67	6091.05	6528.30	7311.11	
Painted MDF	Plank Walnut	S942-PW2-■	N/A	4793.43	5004.99	5117.84	5343.51	5505.71	6232.09	6669.34	7452.15	
Plank White Oak	Painted MDF	S942-WP2-■	N/A	4652.39	4863.95	4976.80	5202.47	5364.67	6091.05	6528.30	7311.11	
Plank White Oak	Plank White Oak	S942-WW2-■	N/A	6471.88	6683.44	6796.29	7021.96	7184.16	7910.54	8347.79	9130.60	
Plank White Oak	Plank Walnut	S942-WW2-■	N/A	6612.92	6824.48	6937.33	7163.00	7325.20	8051.58	8488.83	9271.64	
Plank Walnut	Painted MDF	S942-WP2-■	N/A	5244.77	5456.33	5569.18	5794.85	5957.05	6683.43	7120.68	7903.49	
Plank Walnut	Plank White Oak	S942-WW2-■	N/A	7064.26	7275.82	7388.67	7614.34	7776.54	8502.92	8940.17	9722.98	
Plank Walnut	Plank Walnut	S942-WW2-■	N/A	7205.30	7416.86	7529.71	7755.38	7917.58	8643.96	9081.21	9864.02	
High Screen - Left Hand												
Painted MDF	Painted MDF	S944-PP2-■	N/A	\$2832.90	\$3044.46	\$3157.31	\$3382.98	\$3545.18	\$4271.56	\$4708.81	\$5491.62	
Painted MDF	Plank White Oak	S944-PW2-■	N/A	4652.39	4863.95	4976.80	5202.47	5364.67	6091.05	6528.30	7311.11	
Painted MDF	Plank Walnut	S944-PW2-■	N/A	4793.43	5004.99	5117.84	5343.51	5505.71	6232.09	6669.34	7452.15	
Plank White Oak	Painted MDF	S944-WP2-■	N/A	4652.39	4863.95	4976.80	5202.47	5364.67	6091.05	6528.30	7311.11	
Plank White Oak	Plank White Oak	S944-WW2-■	N/A	6471.88	6683.44	6796.29	7021.96	7184.16	7910.54	8347.79	9130.60	
Plank White Oak	Plank Walnut	S944-WW2-■	N/A	6612.92	6824.48	6937.33	7163.00	7325.20	8051.58	8488.83	9271.64	
Plank Walnut	Painted MDF	S944-WP2-■	N/A	5244.77	5456.33	5569.18	5794.85	5957.05	6683.43	7120.68	7903.49	
Plank Walnut	Plank White Oak	S944-WW2-■	N/A	7064.26	7275.82	7388.67	7614.34	7776.54	8502.92	8940.17	9722.98	
Plank Walnut	Plank Walnut	S944-WW2-■	N/A	7205.30	7416.86	7529.71	7755.38	7917.58	8643.96	9081.21	9864.02	

Tables

Wedge

Wedge

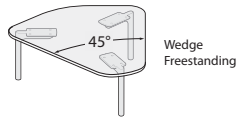

S950

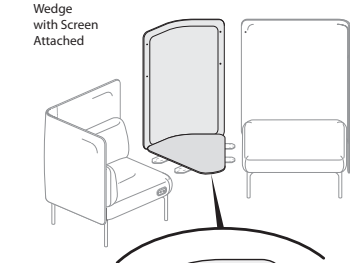

(4) Ganging Brackets (Separately Specified)

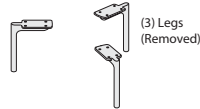

S956

Dimensions

- H: 10"(254mm)
- No Screen
- 42"(1067mm)
- Low Screen
- 54"(1372mm)
- High Screen
- D: 30"(762mm)
- No Screen
- 32"(813mm)
- With Screen
- W: 28"(711mm)

Features

- Includes 1"(25mm) thick 45° table top and three legs with optional Low or High screen.
- Top available in painted MDF or planked wood in White Oak or Walnut.
- Legs - painted cast aluminum.
- Glides - Black plastic or felt with 0.5"(13mm) leveling adjustment.
- COM yardage: (COL N/A on screens)
Screen Low: 2.25/N/A High: 2.5/N/A

To Order, Specify:

- 1) Product number, including:
 - 1** **Glide Style:**
 - H** Plastic Glide
 - K** Felt Glide
- 2) Surface material/color.
- 3) Screen material (if applicable).
- 4) Leg color.

Specification Tips

- Tables without screens can be used as freestanding or ganged to a Cabana seating unit.
- Tables with screens must be ganged to other Cabana seating using separately specified Ganging Brackets or Ganging Kit. Cannot gang to arm, back or screen locations due to interference. For options see Specification Guide.
- Legs should not be used when ganging.
- Screen material applied railroaded.
- Linear or patterned fabric not recommended due to the way material is applied.
- Screens cannot be field modified.
- Product Number changes based on screen height. Please ensure correct Number is ordered.
- Table can be powered with separately specified and field installed Bezel Utility Module EURT-00 __. Bezel Utility Modules ship standard with 6'(1829mm) or 12'(3658mm) cord lengths.
- Screens are designed to work with separately specified:
 - Shelf S9SH-0
 - Coat Hook HOCH-0000
- See Specification Guide for Application Details.

Description	Number 1	Price	Screen Fabric Grade							
			A	B	C	D	E	F	G	H
No Screen										
Painted MDF	S950-P00- <input type="checkbox"/>	\$1650.23	N/A	N/A	N/A	N/A	N/A	N/A	N/A	N/A
Plank White Oak	S950-W00- <input type="checkbox"/>	3751.80	N/A	N/A	N/A	N/A	N/A	N/A	N/A	N/A
Plank Walnut	S950-W00- <input type="checkbox"/>	4654.49	N/A	N/A	N/A	N/A	N/A	N/A	N/A	N/A
Low Screen										
Painted MDF	S955-P02- <input type="checkbox"/>	N/A	\$2669.99	\$2789.89	\$2860.41	\$2987.36	\$3079.03	\$3488.07	\$3741.92	\$4186.23
Plank White Oak	S955-W02- <input type="checkbox"/>	N/A	4771.56	4891.46	4961.98	5088.93	5180.60	5589.64	5843.49	6287.80
Plank Walnut	S955-W02- <input type="checkbox"/>	N/A	5674.25	5794.15	5864.67	5991.62	6083.29	6492.33	6746.18	7190.49
High Screen										
Painted MDF	S956-P02- <input type="checkbox"/>	N/A	\$2669.99	\$2789.89	\$2860.41	\$2987.36	\$3079.03	\$3488.07	\$3741.92	\$4186.23
Plank White Oak	S956-W02- <input type="checkbox"/>	N/A	4771.56	4891.46	4961.98	5088.93	5180.60	5589.64	5843.49	6287.80
Plank Walnut	S956-W02- <input type="checkbox"/>	N/A	5674.25	5794.15	5864.67	5991.62	6083.29	6492.33	6746.18	7190.49

This page intentionally blank

Tables

Wedge Tiered

Wedge Tiered

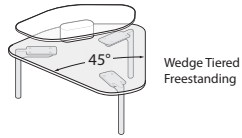

S960

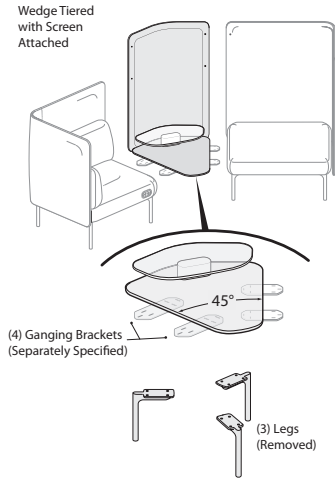

S966

Dimensions

- H: 10"(254mm)
- No Screen
- 42"(1067mm)
- Low Screen
- 54"(1372mm)
- High Screen
- D: 30"(762mm)
- No Screen
- 32"(813mm)
- With Screen
- W: 28"(711mm)

Features

- Includes 1"(25mm) thick 45° wedge shape table top, second tier small rectangular 0.75"(19mm) thick top on stanchion and three legs with optional Low or High screen.
- Lower table surface available in painted MDF or planked wood in White Oak or Walnut.
- Upper surface available in painted MDF or planked wood in White Oak or Walnut. Upper surface material may be different from lower surface.
- Upper surface is 13.5"(343mm) D x 24.75"(629mm) W. Stanchion height is 3.5"(89mm)
- Legs - painted cast aluminum.
- Glides - Black plastic or felt with 0.5"(13mm) leveling adjustment.
- COM yardage: (COL N/A on screens)
Screen Low: 2.25/N/A High: 2.5/N/A

To Order, Specify:

- 1) Product number, including:

1 Glide Style:

- H** Plastic Glide
- K** Felt Glide

- 2) Lower surface material/color.
- 3) Upper surface material/color.
- 4) Screen material (if applicable).
- 5) Trim color.

Specification Tips

- Tables without screens can be used as freestanding or ganged to a Cabana seating unit.
- Tables with screens must be ganged to other Cabana seating using separately specified Ganging Brackets or Ganging Kit. Cannot gang to arm, back or screen locations due to interference. For options see Specification Guide.
- Legs should not be used when ganging.
- Screen material applied railroaded.
- Linear or patterned fabric not recommended due to the way material is applied.
- Screens cannot be field modified.
- Product Number changes based on screen height. Please ensure correct Number is ordered.
- Table can be powered with separately specified and field installed Bezel Utility Module EURT-00 __. Bezel Utility Modules ship standard with 6'(1829mm) or 12'(3658mm) cord lengths.
- The upper tier stanchion mount allows cord management through the table.
- Upper tier stanchion is factory installed and cannot be field modified.
- Screens are designed to work with separately specified:
 - Shelf S9SH-0
 - Coat Hook HOCH-0000
- See Specification Guide for Application Details.

Tables

Wedge Tiered

Lower Surface	Upper Surface	Number ①	Price	Screen Fabric Grade								
				A	B	C	D	E	F	G	H	
No Screen												
Painted MDF	Painted MDF	S960-PP0-■	\$2235.56	N/A	N/A	N/A	N/A	N/A	N/A	N/A	N/A	N/A
Painted MDF	Plank White Oak	S960-PW0-■	3716.56	N/A	N/A	N/A	N/A	N/A	N/A	N/A	N/A	N/A
Painted MDF	Plank Walnut	S960-PW0-■	4619.23	N/A	N/A	N/A	N/A	N/A	N/A	N/A	N/A	N/A
Plain White Oak	Painted MDF	S960-WP0-■	4337.13	N/A	N/A	N/A	N/A	N/A	N/A	N/A	N/A	N/A
Plank White Oak	Plank White Oak	S960-WW0-■	5818.13	N/A	N/A	N/A	N/A	N/A	N/A	N/A	N/A	N/A
Plank White Oak	Plank Walnut	S960-WW0-■	6720.80	N/A	N/A	N/A	N/A	N/A	N/A	N/A	N/A	N/A
Plank Walnut	Painted MDF	S960-WP0-■	5239.82	N/A	N/A	N/A	N/A	N/A	N/A	N/A	N/A	N/A
Plank Walnut	Plank White Oak	S960-WW0-■	6720.82	N/A	N/A	N/A	N/A	N/A	N/A	N/A	N/A	N/A
Plank Walnut	Plank Walnut	S960-WW0-■	7623.49	N/A	N/A	N/A	N/A	N/A	N/A	N/A	N/A	N/A
Low Screen												
Painted MDF	Painted MDF	S965-PP2-■	N/A	\$3255.32	\$3375.22	\$3445.74	\$3572.69	\$3664.36	\$4073.40	\$4327.25	\$ 4771.56	
Painted MDF	Plank White Oak	S965-PW2-■	N/A	4736.32	4856.22	4926.74	5053.69	5145.36	5554.40	5808.25	6252.56	
Painted MDF	Plank Walnut	S965-PW2-■	N/A	5638.99	5758.89	5829.41	5956.36	6048.03	6457.07	6710.92	7155.23	
Plank White Oak	Painted MDF	S965-WP2-■	N/A	5356.89	5476.79	5547.31	5674.26	5765.93	6174.97	6428.82	6873.13	
Plank White Oak	Plank White Oak	S965-WW2-■	N/A	6837.89	6957.79	7028.31	7155.26	7246.93	7655.97	7909.82	8354.13	
Plank White Oak	Plank Walnut	S965-WW2-■	N/A	7740.56	7860.46	7930.98	8057.93	8149.60	8558.64	8812.49	9256.80	
Plank Walnut	Painted MDF	S965-WP2-■	N/A	6259.58	6379.48	6450.00	6576.95	6668.62	7077.66	7331.51	7775.82	
Plank Walnut	Plank White Oak	S965-WW2-■	N/A	7740.58	7860.48	7931.00	8057.95	8149.62	8558.66	8812.51	9256.82	
Plank Walnut	Plank Walnut	S965-WW2-■	N/A	8643.25	8763.15	8833.67	8960.62	9052.29	9461.33	9715.18	10159.49	
High Screen												
Painted MDF	Painted MDF	S966-PP2-■	N/A	\$3255.32	\$3375.22	\$3445.74	\$3572.69	\$3664.36	\$4073.40	\$4327.25	\$ 4771.56	
Painted MDF	Plank White Oak	S966-PW2-■	N/A	4736.32	4856.22	4926.74	5053.69	5145.36	5554.40	5808.25	6252.56	
Painted MDF	Plank Walnut	S966-PW2-■	N/A	5638.99	5758.89	5829.41	5956.36	6048.03	6457.07	6710.92	7155.23	
Plank White Oak	Painted MDF	S966-WP2-■	N/A	5356.89	5476.79	5547.31	5674.26	5765.93	6174.97	6428.82	6873.13	
Plank White Oak	Plank White Oak	S966-WW2-■	N/A	6837.89	6957.79	7028.31	7155.26	7246.93	7655.97	7909.82	8354.13	
Plank White Oak	Plank Walnut	S966-WW2-■	N/A	7740.56	7860.46	7930.98	8057.93	8149.60	8558.64	8812.49	9256.80	
Plank Walnut	Painted MDF	S966-WP2-■	N/A	6259.58	6379.48	6450.00	6576.95	6668.62	7077.66	7331.51	7775.82	
Plank Walnut	Plank White Oak	S966-WW2-■	N/A	7740.58	7860.48	7931.00	8057.95	8149.62	8558.66	8812.51	9256.82	
Plank Walnut	Plank Walnut	S966-WW2-■	N/A	8643.25	8763.15	8833.67	8960.62	9052.29	9461.33	9715.18	10159.49	

Chaise Lounge Retreat*

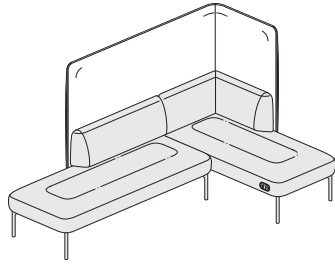

S9EL

Dimensions

- *SH: 17.3"(439mm)
- H: 42"(1067mm)
- Low Screen 54"(1372mm)
- High Screen
- D: 62"(1575mm)
- W: 104"(2642mm)

* All measurements taken with the BIFMA chair measuring device.

Features

- Includes: Two-seat sofa with half back, chaise lounge, low or high 30"(762mm) x 72"(1829mm) screen, along with integrated table and embedded power options.
- Embedded Power available in two options:
 - Power - Two Power Receptacles (NEMA-5-15R) per location)
 - Power + USB - One Power Receptacle (NEMA-5-15R) and two stacked USB 2.0 ports (2A of charging power[5 volts] per USB outlet).
- Power is embedded on unit front on left or right-hand side, or both. When ordering power on both sides the power option will be the same.
- Power housing available in supplier Black or White and has a 10'(3048mm) black cord.
- Integrated table option available on the Half-Back Sofa.
- Integrated table is 0.75"(19mm) thick and 20"(508mm)D x 11"(279mm)W mounted on a 3.5"(89mm)H stanchion.
- Legs - painted cast aluminum.
- Glides - Black plastic or felt with 0.5"(13mm) leveling adjustment.
- COM yardage/COL square footage:
 - Seating: 8.25/142.25
 - Screens Low: 6.25/N/A High: 6.5/N/A

Specification Tips

- Gangs on open seat depth with separately specified Cabana seating or tables with or without a screen. Use separately specified Ganging Bracket or Ganging Kit.
- Cannot gang on screen locations due to interference. For options see Specification Guide.
- Chaise Lounge Retreat is handed and comes standard with Low or High screen.
- Sofa and screen fabric are applied railroaded.
- Linear or patterned fabric not recommended due to the way material is applied.
- Seat and Screen may be specified with different materials. To specify, select seat material grade. Next, select screen material and add appropriate upcharge (see chart).
- Embedded Power is factory installed and cannot be field installed. Power type can be field modified with service parts.
- **For use with 120 volt 60 hertz electrical system only.**
- Place powered seating within 4'(1219mm) of power source. Power components each have a 10'(3048mm) cord routed to an opening at rear of seating unit.
- Integrated Table is factory installed. The table position is fixed and cannot be field modified.
- The Integrated Table is designed to work with separately specified, field installed, Bezel Utility Module EURT-00__. Table stanchion allows cord management through the seat. Bezel Utility Modules ship standard with 6'(1829mm) or 12'(3658mm) cord lengths.
- The following separately specified items are designed to work with Cabana screens. It is recommended to use these items on High Screens to prevent interference with user.
 - Shelf S9SH-0
 - Coat Hook HOCH-0000
- See Specification Guide for Application Details.
- Powered applications may require approval of local authority having jurisdiction (AHJ); ensure compliance before placing orders or installing.

To Order, Specify:

1) Product number, including:

1 Seat Upholstery Type:

- 1 Leather
- 2 Fabric

2 Power Option:

0 None

Power

1 Right Power - Black, add \$324.41 to list

A Right Power - White, add \$324.41 to list

2 Left Power - Black, add \$324.41 to list

B Left Power - White, add \$324.41 to list

3 Right + Left Power - Black, add \$648.81 to list

C Right + Left Power - White, add \$648.81 to list

Power + USB

4 Right Power + USB - Black, add \$409.03 to list

D Right Power + USB - White, add \$409.03 to list

5 Left Power + USB - Black, add \$409.03 to list

E Left Power + USB - White, add \$409.03 to list

6 Right + Left Power + USB - Black, add \$818.07 to list

F Right + Left Power + USB - White, add \$818.07 to list

3 Glide Option:

H Plastic Glide

K Felt Glide

2) Seat, back & arm material.

3) Screen material. See chart (next page) for upcharge.

4) Trim color.

5) Table finish (if applicable).

*This product may be subject to supplemental freight charges.

Chaise Lounge Retreat

Description	Number			Seat, Back & Arms Fabric Grade								Leather Grade A	Leather Grade B
	①	②	③	A	B	C	D	E	F	G	H		
Low Screen* - No Integrated Table													
Right-Hand	S9ER-L	2-	00	\$ 9586.86	\$10066.42	\$10334.40	\$10849.22	\$11208.88	\$12880.28	\$13874.64	\$15665.92	\$13931.06	\$15736.43
Left-Hand	S9EL-L	2-	00	9586.86	10066.42	10334.40	10849.22	11208.88	12880.28	13874.64	15665.92	13931.06	15736.43
Low Screen* - Integrated Table Painted MDF													
Right-Hand	S9ER-L	2-	P0	\$10172.19	\$10651.75	\$10919.73	\$11434.55	\$11794.21	\$13465.61	\$14459.97	\$16251.25	\$14516.39	\$16321.76
Left-Hand	S9EL-L	2-	P0	10172.19	10651.75	10919.73	11434.55	11794.21	13465.61	14459.97	16251.25	14516.39	16321.76
Low Screen* - Integrated Table Plank White Oak													
Right-Hand	S9ER-L	2-	W0	\$11554.46	\$12034.02	\$12302.00	\$12816.82	\$13176.48	\$14847.88	\$15842.24	\$17633.52	\$15898.66	\$17704.03
Left-Hand	S9EL-L	2-	W0	11554.46	12034.02	12302.00	12816.82	13176.48	14847.88	15842.24	17633.52	15898.66	17704.03
Low Screen* - Integrated Table Plank Walnut													
Right-Hand	S9ER-L	2-	W0	\$11674.32	\$12153.88	\$12421.86	\$12936.68	\$13296.34	\$14967.74	\$15962.10	\$17753.38	\$16018.52	\$17823.89
Left-Hand	S9EL-L	2-	W0	11674.32	12153.88	12421.86	12936.68	13296.34	14967.74	15962.10	17753.38	16018.52	17823.89
High Screen* - No Integrated Table													
Right-Hand	S9ER-H	2-	00	\$ 9586.86	\$10066.42	\$10334.40	\$10849.22	\$11208.88	\$12880.28	\$13874.64	\$15665.92	\$13931.06	\$15736.43
Left-Hand	S9EL-H	2-	00	9586.86	10066.42	10334.40	10849.22	11208.88	12880.28	13874.64	15665.92	13931.06	15736.43
High Screen* - Integrated Table Painted MDF													
Right-Hand	S9ER-H	2-	P0	\$10172.19	\$10651.75	\$10919.73	\$11434.55	\$11794.21	\$13465.61	\$14459.97	\$16251.25	\$14516.39	\$16321.76
Left-Hand	S9EL-H	2-	P0	10172.19	10651.75	10919.73	11434.55	11794.21	13465.61	14459.97	16251.25	14516.39	16321.76
High Screen* - Integrated Table Plank White Oak													
Right-Hand	S9ER-H	2-	W0	\$11554.46	\$12034.02	\$12302.00	\$12816.82	\$13176.48	\$14847.88	\$15842.24	\$17633.52	\$15898.66	\$17704.03
Left-Hand	S9EL-H	2-	W0	11554.46	12034.02	12302.00	12816.82	13176.48	14847.88	15842.24	17633.52	15898.66	17704.03
High Screen* - Integrated Table Plank Walnut													
Right-Hand	S9ER-H	2-	W0	\$11674.32	\$12153.88	\$12421.86	\$12936.68	\$13296.34	\$14967.74	\$15962.10	\$17753.38	\$16018.52	\$17823.89
Left-Hand	S9EL-H	2-	W0	11674.32	12153.88	12421.86	12936.68	13296.34	14967.74	15962.10	17753.38	16018.52	17823.89

*Pricing shown for Low and High Screen reflects screen Grade A pricing. Reference chart for upcharge amounts for higher grade pricing.

The following option requires modification of the product number.

Stain repellent
(not applicable to screens)

To specify, add **P** to the end of the product number; **Example:** S9ER-L22-000HP (add **\$225.68** to list)

Description	A	B	C	D	E	F	G	H
Low Screen (2) 30" x 21"	N/A	\$423.14	\$648.81	\$1100.16	\$1424.56	\$2877.33	\$3751.81	\$5317.41
High Screen (2) 30" x 21"	N/A	\$423.14	\$648.81	\$1100.16	\$1424.56	\$2877.33	\$3751.81	\$5317.41

This page intentionally blank

Half-Back Sofa Retreat*

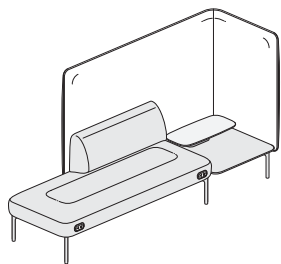

S9F

Dimensions

*SH: 17.3"(439mm)
 H: 42"(1067mm)
 Low Screen
 54"(1372mm)
 High Screen
 D: 30"(762mm)
 W: 104"(2642mm)

* All measurements taken with the BIFMA chair measuring device.

Features

- Includes: Two-seat sofa with half back, square corner table and low or high 30"(762mm) x 72"(1829mm) screen, along with integrated table and embedded power options.
- Embedded Power available in two options:
 - Power - Two Power Receptacles (NEMA-5-15R) per location
 - Power + USB - One Power Receptacle (NEMA-5-15R) and two stacked USB 2.0 ports (2A of charging power[5 volts] per USB outlet).
- Power is embedded on unit front on left or right-hand side, or both. When ordering power on both sides the power option will be the same.
- Power housing available in supplier Black or White and has a 10'(3048mm) black cord.
- Square corner table available with or without an upper tier surface.
- Integrated table option available on the Half-Back Sofa.
- Integrated table is 0.75"(19mm) thick and 20"(508mm)D x 11"(279mm)W mounted on a 3.5"(89mm)H stanchion.
- Legs - painted cast aluminum.
- Glides - Black plastic or felt with 0.5"(13mm) leveling adjustment.
- COM yardage/COL square footage:
 Seating: 4.0/70
 Screens Low: 6.25/N/A High: 6.5/N/A

Specification Tips

- Gangs on open seat depth with separately specified Cabana seating or tables with or without a screen. Use separately specified Ganging Bracket or Ganging Kit.
- Cannot gang on screen locations due to interference. For options see Specification Guide.
- Half-Back Sofa Retreat is handed and comes standard with Low or High screen.
- Sofa and screen fabric are applied railroaded.
- Linear or patterned fabric not recommended due to the way material is applied.
- Seat and Screen may be specified with different materials. To specify, select seat material grade. Next, select screen material and add appropriate upcharge (see chart).
- Embedded Power is factory installed and cannot be field installed. Power type can be field modified with service parts.
- For use with 120 volt 60 hertz electrical system only.**
- Place powered seating within 4'(1219mm) of power source. Power components each have a 10'(3048mm) cord routed to a corresponding opening at rear of seating unit.
- Integrated Table is factory installed. The table position is fixed and cannot be field modified.
- The Integrated Table is designed to work with separately specified, field installed, Bezel Utility Module EURT-00__ . Table stanchion allows cord management through the seat. Bezel Utility Modules ship standard with 6'(1829mm) or 12'(3658mm) cord lengths.
- The following separately specified items are designed to work with Cabana screens. It is recommended to use these items on High Screens or over a table to prevent interference with user.
 - Shelf S9SH-0
 - Coat Hook HOCH-0000
- See Specification Guide for Application Details.
- Powered applications may require approval of local authority having jurisdiction (AHJ); ensure compliance before placing orders or installing.

To Order, Specify:

1) Product number, including:

1 Screen Handedness:

- Z** Left Hand
- H** Right Hand

2 Seat Upholstery Type:

- 1** Leather
- 2** Fabric

3 Power Option:

- 0** None
- Power*
- 1** Right Power - Black, add **\$324.41** to list
 - A** Right Power - White, add **\$324.41** to list
 - 2** Left Power - Black, add **\$324.41** to list
 - B** Left Power - White, add **\$324.41** to list
 - 3** Right + Left Power - Black, add **\$648.81** to list
 - C** Right + Left Power - White, add **\$648.81** to list

Power + USB

- 4** Right Power + USB - Black, add **\$409.03** to list
- D** Right Power + USB - White, add **\$409.03** to list
- 5** Left Power + USB - Black, add **\$409.03** to list
- E** Left Power + USB - White, add **\$409.03** to list
- 6** Right + Left Power + USB - Black, add **\$818.07** to list
- F** Right + Left Power + USB - White, add **\$818.07** to list

4 Glide Option:

- H** Plastic Glide
- K** Felt Glide

- 2) Seat, back & arm material.
- 3) Screen material.
See chart (page 39) for upcharge.
- 4) Trim color.
- 5) Integrated table surface/color (if applicable).
- 6) Corner table surface/color.
- 7) Upper corner table surface/color (if applicable).

*This product may be subject to supplemental freight charges.

Half-Back Sofa Retreat

Lower Surface	Upper Surface	Number				Seat, Back & Arms Fabric Grade								Leather Grade A	Leather Grade B
		①	②	③	④	A	B	C	D	E	F	G	H		
Low Screen* - No Integrated Table															
Painted MDF	None	S9F	-L	2-	01	\$ 7760.32	\$ 7986.00	\$ 8112.93	\$ 8352.70	\$ 8521.97	\$ 9304.78	\$ 9770.22	\$ 10609.43	\$ 9868.95	\$ 10715.24
	Painted MDF	S9F	-L	2-	03	8345.65	8571.33	8698.26	8938.03	9107.30	9890.11	10355.55	11194.76	10454.28	11300.57
	Plank White Oak	S9F	-L	2-	04	9960.64	10186.32	10313.25	10553.02	10722.29	11505.10	11970.54	12809.75	12069.27	12915.56
	Plank Walnut	S9F	-L	2-	04	10052.32	10278.00	10404.93	10644.70	10813.97	11596.78	12062.22	12901.43	12160.95	13007.24
Plank White Oak	None	S9F	-L	2-	02	\$ 9685.59	\$ 9911.27	\$ 10038.20	\$ 10277.97	\$ 10447.24	\$ 11230.05	\$ 11695.49	\$ 12534.70	\$ 11794.22	\$ 12640.51
	Painted MDF	S9F	-L	2-	05	10270.92	10496.60	10623.53	10863.30	11032.57	11815.38	12280.82	13120.03	12379.55	13225.84
	Plank White Oak	S9F	-L	2-	06	11885.91	12111.59	12238.52	12478.29	12647.56	13430.37	13895.81	14735.02	13994.54	14840.83
	Plank Walnut	S9F	-L	2-	06	11977.59	12203.27	12330.20	12569.97	12739.24	13522.05	13987.49	14826.70	14086.22	14932.51
Plank Walnut	None	S9F	-L	2-	02	\$ 10581.23	\$ 10806.91	\$ 10933.84	\$ 11173.61	\$ 11342.88	\$ 12125.69	\$ 12591.13	\$ 13430.34	\$ 12689.86	\$ 13536.15
	Painted MDF	S9F	-L	2-	05	11166.56	11392.24	11519.17	11758.94	11928.21	12711.02	13176.46	14015.67	13275.19	14121.48
	Plank White Oak	S9F	-L	2-	06	12781.55	13007.23	13134.16	13373.93	13543.20	14326.01	14791.45	15630.66	14890.18	15736.47
	Plank Walnut	S9F	-L	2-	06	12873.23	13098.91	13225.84	13465.61	13634.88	14417.69	14883.13	15722.34	14981.86	15828.15
Low Screen* - Integrated Table Painted MDF															
Painted MDF	None	S9F	-L	2-	P1	\$ 8345.65	\$ 8571.33	\$ 8698.26	\$ 8938.03	\$ 9107.30	\$ 9890.11	\$ 10355.55	\$ 11194.76	\$ 10454.28	\$ 11300.57
	Painted MDF	S9F	-L	2-	P3	8930.98	9156.66	9283.59	9523.36	9692.63	10475.44	10940.88	11780.09	11039.61	11885.90
	Plank White Oak	S9F	-L	2-	P4	10545.97	10771.65	10898.58	11138.35	11307.62	12090.43	12555.87	13395.08	12654.60	13500.89
	Plank Walnut	S9F	-L	2-	P4	10637.65	10863.33	10990.26	11230.03	11399.30	12182.11	12647.55	13486.76	12746.28	13592.57
Plank White Oak	None	S9F	-L	2-	P2	\$ 10270.92	\$ 10496.60	\$ 10623.53	\$ 10863.30	\$ 11032.57	\$ 11815.38	\$ 12280.82	\$ 13120.03	\$ 12379.55	\$ 13225.84
	Painted MDF	S9F	-L	2-	P5	10856.25	11081.93	11208.86	11448.63	11617.90	12400.71	12866.15	13705.36	12964.88	13811.17
	Plank White Oak	S9F	-L	2-	P6	12471.24	12696.92	12823.85	13063.62	13232.89	14015.70	14481.14	15320.35	14579.87	15426.16
	Plank Walnut	S9F	-L	2-	P6	12562.92	12788.60	12915.53	13155.30	13324.57	14107.38	14572.82	15412.03	14671.55	15517.84
Plank Walnut	None	S9F	-L	2-	P2	\$ 11166.56	\$ 11392.24	\$ 11519.17	\$ 11758.94	\$ 11928.21	\$ 12711.02	\$ 13176.46	\$ 14015.67	\$ 13275.19	\$ 14121.48
	Painted MDF	S9F	-L	2-	P5	11751.89	11977.57	12104.50	12344.27	12513.54	13296.35	13761.79	14601.00	13860.52	14706.81
	Plank White Oak	S9F	-L	2-	P6	13366.88	13592.56	13719.49	13959.26	14128.53	14911.34	15376.78	16215.99	15475.51	16321.80
	Plank Walnut	S9F	-L	2-	P6	13458.56	13684.24	13811.17	14050.94	14220.21	15003.02	15468.46	16307.67	15567.19	16413.48
Low Screen* - Integrated Table Plank White Oak															
Painted MDF	None	S9F	-L	2-	W1	\$ 9727.92	\$ 9953.60	\$ 10080.53	\$ 10320.30	\$ 10489.57	\$ 11272.38	\$ 11737.82	\$ 12577.03	\$ 11836.55	\$ 12682.84
	Painted MDF	S9F	-L	2-	W3	10313.25	10538.93	10665.86	10905.63	11074.90	11857.71	12323.15	13162.36	12421.88	13268.17
	Plank White Oak	S9F	-L	2-	W4	11928.24	12153.92	12280.85	12520.62	12689.89	13472.70	13938.14	14777.35	14036.87	14883.16
	Plank Walnut	S9F	-L	2-	W4	12019.92	12245.60	12372.53	12612.30	12781.57	13564.38	14029.82	14869.03	14128.55	14974.84
Plank White Oak	None	S9F	-L	2-	W2	\$ 11653.19	\$ 11878.87	\$ 12005.80	\$ 12245.57	\$ 12414.84	\$ 13197.65	\$ 13663.09	\$ 14502.30	\$ 13761.82	\$ 14608.11
	Painted MDF	S9F	-L	2-	W5	12238.52	12464.20	12591.13	12830.90	13000.17	13782.98	14248.42	15087.63	14347.15	15193.44
	Plank White Oak	S9F	-L	2-	W6	13853.51	14079.19	14206.12	14445.89	14615.16	15397.97	15863.41	16702.62	15962.14	16808.43
	Plank Walnut	S9F	-L	2-	W6	13945.19	14170.87	14297.80	14537.57	14706.84	15489.65	15955.09	16794.30	16053.82	16900.11
Plank Walnut	None	S9F	-L	2-	W2	\$ 12548.83	\$ 12774.51	\$ 12901.44	\$ 13141.21	\$ 13310.48	\$ 14093.29	\$ 14558.73	\$ 15397.94	\$ 14657.46	\$ 15503.75
	Painted MDF	S9F	-L	2-	W5	13134.16	13359.84	13486.77	13726.54	13895.81	14678.62	15144.06	15983.27	15242.79	16089.08
	Plank White Oak	S9F	-L	2-	W6	14749.15	14974.83	15101.76	15341.53	15510.80	16293.61	16759.05	17598.26	16857.78	17704.07
	Plank Walnut	S9F	-L	2-	W6	14840.83	15066.51	15193.44	15433.21	15602.48	16385.29	16850.73	17689.94	16949.46	17795.75
Low Screen* - Integrated Table Plank Walnut															
Painted MDF	None	S9F	-L	2-	W1	\$ 9847.78	\$ 10073.46	\$ 10200.39	\$ 10440.16	\$ 10609.43	\$ 11392.24	\$ 11857.68	\$ 12696.89	\$ 11956.41	\$ 12802.70
	Painted MDF	S9F	-L	2-	W3	10433.11	10658.79	10785.72	11025.49	11194.76	11977.57	12443.01	13282.22	12541.74	13388.03
	Plank White Oak	S9F	-L	2-	W4	12048.10	12273.78	12400.71	12640.48	12809.75	13592.56	14058.00	14897.21	14156.73	15003.02
	Plank Walnut	S9F	-L	2-	W4	12139.78	12365.46	12492.39	12732.16	12901.43	13684.24	14149.68	14988.89	14248.41	15094.70
Plank White Oak	None	S9F	-L	2-	W2	\$ 11773.05	\$ 11998.73	\$ 12125.66	\$ 12365.43	\$ 12534.70	\$ 13317.51	\$ 13782.95	\$ 14622.16	\$ 13881.68	\$ 14727.97
	Painted MDF	S9F	-L	2-	W5	12358.38	12584.06	12710.99	12950.76	13120.03	13902.84	14368.28	15207.49	14467.01	15313.30
	Plank White Oak	S9F	-L	2-	W6	13973.37	14199.05	14325.98	14565.75	14735.02	15517.83	15983.27	16822.48	16082.00	16928.29
	Plank Walnut	S9F	-L	2-	W6	14065.05	14290.73	14417.66	14657.43	14826.70	15609.51	16074.95	16914.16	16173.68	17019.97
Plank Walnut	None	S9F	-L	2-	W2	\$ 12668.69	\$ 12894.37	\$ 13021.30	\$ 13261.07	\$ 13430.34	\$ 14213.15	\$ 14678.59	\$ 15517.80	\$ 14777.32	\$ 15623.61
	Painted MDF	S9F	-L	2-	W5	13254.02	13479.70	13606.63	13846.40	14015.67	14798.48	15263.92	16103.13	15362.65	16208.94
	Plank White Oak	S9F	-L	2-	W6	14869.01	15094.69	15221.62	15461.39	15630.66	16413.47	16878.91	17718.12	16977.64	17823.93
	Plank Walnut	S9F	-L	2-	W6	14960.69	15186.37	15313.30	15553.07	15722.34	16505.15	16970.59	17809.80	17069.32	17915.61

*Pricing shown for Low and High Screen reflects screen Grade A pricing. Reference chart for upcharge amounts for higher grade pricing.

Half-Back Sofa Retreat

Lower Surface	Upper Surface	Number ① ② ③ ④	Seat, Back & Arms Fabric Grade								Leather Grade A	Leather Grade B
			A	B	C	D	E	F	G	H		
High Screen* - No Integrated Table												
Painted MDF	None	S9F -H 2- 01	\$ 7760.32	\$ 7986.00	\$ 8112.93	\$ 8352.70	\$ 8521.97	\$ 9304.78	\$ 9770.22	\$ 10609.43	\$ 9868.95	\$ 10715.24
	Painted MDF	S9F -H 2- 03	8345.65	8571.33	8698.26	8938.03	9107.30	9890.11	10355.55	11194.76	10454.28	11300.57
	Plank White Oak	S9F -H 2- 04	9960.64	10186.32	10313.25	10553.02	10722.29	11505.10	11970.54	12809.75	12069.27	12915.56
	Plank Walnut	S9F -H 2- 04	10052.32	10278.00	10404.93	10644.70	10813.97	11596.78	12062.22	12901.43	12160.95	13007.24
Plank White Oak	None	S9F -H 2- 02	\$ 9685.59	\$ 9911.27	\$ 10038.20	\$ 10277.97	\$ 10447.24	\$ 11230.05	\$ 11695.49	\$ 12534.70	\$ 11794.22	\$ 12640.51
	Painted MDF	S9F -H 2- 05	10270.92	10496.60	10623.53	10863.30	11032.57	11815.38	12280.82	13120.03	12379.55	13225.84
	Plank White Oak	S9F -H 2- 06	11885.91	12111.59	12238.52	12478.29	12647.56	13430.37	13895.81	14735.02	13994.54	14840.83
	Plank Walnut	S9F -H 2- 06	11977.59	12203.27	12330.20	12569.97	12739.24	13522.05	13987.49	14826.70	14086.22	14932.51
Plank Walnut	None	S9F -H 2- 02	\$ 10581.23	\$ 10806.91	\$ 10933.84	\$ 11173.61	\$ 11342.88	\$ 12125.69	\$ 12591.13	\$ 13430.34	\$ 12689.86	\$ 13536.15
	Painted MDF	S9F -H 2- 05	11166.56	11392.24	11519.17	11758.94	11928.21	12711.02	13176.46	14015.67	13275.19	14121.48
	Plank White Oak	S9F -H 2- 06	12781.55	13007.23	13134.16	13373.93	13543.20	14326.01	14791.45	15630.66	14890.18	15736.47
	Plank Walnut	S9F -H 2- 06	12873.23	13098.91	13225.84	13465.61	13634.88	14417.69	14883.13	15722.34	14981.86	15828.15
High Screen* - Integrated Table Painted MDF												
Painted MDF	None	S9F -H 2- P1	\$ 8345.65	\$ 8571.33	\$ 8698.26	\$ 8938.03	\$ 9107.30	\$ 9890.11	\$ 10355.55	\$ 11194.76	\$ 10454.28	\$ 11300.57
	Painted MDF	S9F -H 2- P3	8930.98	9156.66	9283.59	9523.36	9692.63	10475.44	10940.88	11780.09	11039.61	11885.90
	Plank White Oak	S9F -H 2- P4	10545.97	10771.65	10898.58	11138.35	11307.62	12090.43	12555.87	13395.08	12654.60	13500.89
	Plank Walnut	S9F -H 2- P4	10637.65	10863.33	10990.26	11230.03	11399.30	12182.11	12647.55	13486.76	12746.28	13592.57
Plank White Oak	None	S9F -H 2- P2	\$ 10270.92	\$ 10496.60	\$ 10623.53	\$ 10863.30	\$ 11032.57	\$ 11815.38	\$ 12280.82	\$ 13120.03	\$ 12379.55	\$ 13225.84
	Painted MDF	S9F -H 2- P5	10856.25	11081.93	11208.86	11448.63	11617.90	12400.71	12866.15	13705.36	12964.88	13811.17
	Plank White Oak	S9F -H 2- P6	12471.24	12696.92	12823.85	13063.62	13232.89	14015.70	14481.14	15320.35	14579.87	15426.16
	Plank Walnut	S9F -H 2- P6	12562.92	12788.60	12915.53	13155.30	13324.57	14107.38	14572.82	15412.03	14671.55	15517.84
Plank Walnut	None	S9F -H 2- P2	\$ 11166.56	\$ 11392.24	\$ 11519.17	\$ 11758.94	\$ 11928.21	\$ 12711.02	\$ 13176.46	\$ 14015.67	\$ 13275.19	\$ 14121.48
	Painted MDF	S9F -H 2- P5	11751.89	11977.57	12104.50	12344.27	12513.54	13296.35	13761.79	14601.00	13860.52	14706.81
	Plank White Oak	S9F -H 2- P6	13366.88	13592.56	13719.49	13959.26	14128.53	14911.34	15376.78	16215.99	15475.51	16321.80
	Plank Walnut	S9F -H 2- P6	13458.56	13684.24	13811.17	14050.94	14220.21	15003.02	15468.46	16307.67	15567.19	16413.48
High Screen* - Integrated Table Plank White Oak												
Painted MDF	None	S9F -H 2- W1	\$ 9727.92	\$ 9953.60	\$ 10080.53	\$ 10320.30	\$ 10489.57	\$ 11272.38	\$ 11737.82	\$ 12577.03	\$ 11836.55	\$ 12682.84
	Painted MDF	S9F -H 2- W3	10313.25	10538.93	10665.86	10905.63	11074.90	11857.71	12323.15	13162.36	12421.88	13268.17
	Plank White Oak	S9F -H 2- W4	11928.24	12153.92	12280.85	12520.62	12689.89	13472.70	13938.14	14777.35	14036.87	14883.16
	Plank Walnut	S9F -H 2- W4	12019.92	12245.60	12372.53	12612.30	12781.57	13564.38	14029.82	14869.03	14128.55	14974.84
Plank White Oak	None	S9F -H 2- W2	\$ 11653.19	\$ 11878.87	\$ 12005.80	\$ 12245.57	\$ 12414.84	\$ 13197.65	\$ 13663.09	\$ 14502.30	\$ 13761.82	\$ 14608.11
	Painted MDF	S9F -H 2- W5	12238.52	12464.20	12591.13	12830.90	13000.17	13782.98	14248.42	15087.63	14347.15	15193.44
	Plank White Oak	S9F -H 2- W6	13853.51	14079.19	14206.12	14445.89	14615.16	15397.97	15863.41	16702.62	15962.14	16808.43
	Plank Walnut	S9F -H 2- W6	13945.19	14170.87	14297.80	14537.57	14706.84	15489.65	15955.09	16794.30	16053.82	16900.11
Plank Walnut	None	S9F -H 2- W2	\$ 12548.83	\$ 12774.51	\$ 12901.44	\$ 13141.21	\$ 13310.48	\$ 14093.29	\$ 14558.73	\$ 15397.94	\$ 14657.46	\$ 15503.75
	Painted MDF	S9F -H 2- W5	13134.16	13359.84	13486.77	13726.54	13895.81	14678.62	15144.06	15983.27	15242.79	16089.08
	Plank White Oak	S9F -H 2- W6	14749.15	14974.83	15101.76	15341.53	15510.80	16293.61	16759.05	17598.26	16857.78	17704.07
	Plank Walnut	S9F -H 2- W6	14840.83	15066.51	15193.44	15433.21	15602.48	16385.29	16850.73	17689.94	16949.46	17795.75
High Screen* - Integrated Table Plank Walnut												
Painted MDF	None	S9F -H 2- W1	\$ 9847.78	\$ 10073.46	\$ 10200.39	\$ 10440.16	\$ 10609.43	\$ 11392.24	\$ 11857.68	\$ 12696.89	\$ 11956.41	\$ 12802.70
	Painted MDF	S9F -H 2- W3	10433.11	10658.79	10785.72	11025.49	11194.76	11977.57	12443.01	13282.22	12541.74	13388.03
	Plank White Oak	S9F -H 2- W4	12048.10	12273.78	12400.71	12640.48	12809.75	13592.56	14058.00	14897.21	14156.73	15003.02
	Plank Walnut	S9F -H 2- W4	12139.78	12365.46	12492.39	12732.16	12901.43	13684.24	14149.68	14988.89	14248.41	15094.70
Plank White Oak	None	S9F -H 2- W2	\$ 11773.05	\$ 11998.73	\$ 12125.66	\$ 12365.43	\$ 12534.70	\$ 13317.51	\$ 13782.95	\$ 14622.16	\$ 13881.68	\$ 14727.97
	Painted MDF	S9F -H 2- W5	12358.38	12584.06	12710.99	12950.76	13120.03	13902.84	14368.28	15207.49	14467.01	15313.30
	Plank White Oak	S9F -H 2- W6	13973.37	14199.05	14325.98	14565.75	14735.02	15517.83	15983.27	16822.48	16082.00	16928.29
	Plank Walnut	S9F -H 2- W6	14065.05	14290.73	14417.66	14657.43	14826.70	15609.51	16074.95	16914.16	16173.68	17019.97
Plank Walnut	None	S9F -H 2- W2	\$ 12668.69	\$ 12894.37	\$ 13021.30	\$ 13261.07	\$ 13430.34	\$ 14213.15	\$ 14678.59	\$ 15517.80	\$ 14777.32	\$ 15623.61
	Painted MDF	S9F -H 2- W5	13254.02	13479.70	13606.63	13846.40	14015.67	14798.48	15263.92	16103.13	15362.65	16208.94
	Plank White Oak	S9F -H 2- W6	14869.01	15094.69	15221.62	15461.39	15630.66	16413.47	16878.91	17718.12	16977.64	17823.93
	Plank Walnut	S9F -H 2- W6	14960.69	15186.37	15313.30	15553.07	15722.34	16505.15	16970.59	17809.80	17069.32	17915.61

*Pricing shown for Low and High Screen reflects screen Grade A pricing. Reference chart for upcharge amounts for higher grade pricing.

The following option requires modification of the product number.

Stain repellent
(not applicable to screens)

To specify, add **P** to the end of the product number; **Example:** S9FR-L22-001HP (add **\$105.79** to list)

Description	A	B	C	D	E	F	G	H
Low Screen (2) 30" x 21"	N/A	\$423.14	\$648.81	\$1100.16	\$1424.56	\$2877.33	\$3751.81	\$5317.41
High Screen (2) 30" x 21"	N/A	\$423.14	\$648.81	\$1100.16	\$1424.56	\$2877.33	\$3751.81	\$5317.41

Lounge Island*

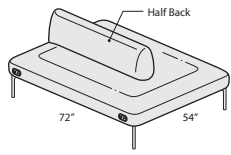

S9GK-2_OH

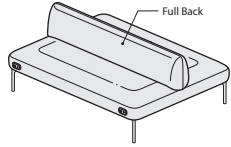

S9GB-2_OH

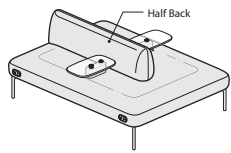

S9GK-2_PH

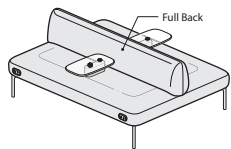

S9GB-2_PH

Dimensions

- *SH: 17.3"(439mm)
- H: 30.5"(775mm)
- D: 54"(1372mm)
- W: 72"(1829mm)
- SW: 72"(1829mm)
- *SD: 21.125"(537mm)
on each side

* All measurements taken with the BIFMA chair measuring device.

Features

- Includes Island sofa on four legs. Sofa can be specified with half-back, full-back, integrated table and embedded power.
- Embedded Power available in two options:
 - Power - Two Power Receptacles (NEMA-5-15R) per location.
 - Power + USB - One Power Receptacle (NEMA-5-15R) and two stacked USB 2.0 ports (2A of charging power [5 volts] per USB outlet).
- Power is embedded on Island mirrored (two power) or on all four corners (four power). Refer to specification guide for visual reference of power location. When two power locations are ordered:
 - Half-back Island will have power mirrored on the half-back side of the sofa.
 - Full-Back Island will have power mirrored on one side of the sofa.
- Power housing is available in supplier Black or White and has 10'(3048mm) black cord.
- Integrated table option available on half-back or full-back Island and will be located on both sides of the unit.
- Integrated table is 0.75"(19mm) thick and 20"(508mm)D x 11"(279mm)W mounted on a 3.5"(89mm)H stanchion.
- Legs are painted cast aluminum.
- Glides are black plastic with 0.5"(13mm) leveling adjustment.
- COM yardage:
 - Half-Back: 7.0
 - Full-Back: 8.0

Specification Tips

- Gangs with other Cabana Lounge Island units using separately specified Ganging Bracket.
- Fabric applied railroaded.
- Linear or patterned fabric not recommended due to the way the material is applied.
- Embedded Power is factory installed and cannot be field installed. Power type can be field modified with service parts.
- **For use with 120 volt 60 hertz electrical system only.**
- Place powered seating within 4'(1219mm) of power source.
- Integrated table is factory installed. The table position is fixed and cannot be field modified.
- The integrated table is designed to work with separately specified, field installed, Bezel Utility Module EURT-00__. Table stanchion allows cord management through the seat. Bezel Utility Modules ship standard with 6'(1829mm) or 12'(3658mm) cord lengths.

To Order, Specify:

1) Product number, including:

1 Power Option:

0 None

Power

1 Two Power - Black, add **\$643.71** list

A Two Power - White, add **\$643.71** list

3 Four Power - Black, add **\$1287.45** list

C Four Power - White, add **\$1287.45** list

Power + USB

4 Two Power + USB - Black, add **\$814.71** list

D Two Power + USB - White, add **\$814.71** list

6 Four Power + USB - Black, add **\$1629.40** list

F Four Power + USB - White, add **\$1629.40** list

2) Seat and back material.

3) Table finish (if applicable).

4) Leg color.

*This product may be subject to supplemental freight charges.

Lounge Island

Description	Number ①	Seat & Back Fabric Grade		C	D	E	F	G	H	
		A	B							
No Integrated Table										
Half Back	S9GK-2 -OH	\$ 6914.03	\$ 7156.03	\$ 7621.16	\$ 7926.02	\$ 9392.32	\$10331.55	\$11881.29	\$13069.43	
Full Back	S9GB-2 -OH	7574.14	7839.21	8348.77	8682.73	10289.03	11317.92	13015.63	14317.19	
Integrated Table - Painted MDF										
Half Back	S9GK-2 -PH	\$ 9199.64	\$ 9441.64	\$ 9906.77	\$10211.63	\$11677.93	\$12617.16	\$14166.90	\$15355.04	
Full Back	S9GB-2 -PH	9859.75	10124.82	10634.38	10968.34	12574.64	13603.53	15301.24	16602.80	
Integrated Table - Plank White Oak										
Half Back	S9GK-2 -WH	\$11967.37	\$12209.37	\$12674.50	\$12979.36	\$14445.66	\$15384.89	\$16934.63	\$18122.77	
Full Back	S9GB-2 -WH	12627.48	12892.55	13402.11	13736.07	15342.37	16371.26	18068.97	19370.53	
Integrated Table - Plank Walnut										
Half Back	S9GK-2 -WH	\$12217.36	\$12459.36	\$12924.49	\$13229.35	\$14695.65	\$15634.88	\$17184.62	\$18372.76	
Full Back	S9GB-2 -WH	12877.47	13142.54	13652.10	13986.06	15592.36	16621.25	18318.96	19620.52	

The following option requires modification of the product number.

Stain repellent

To specify, add **P** to the end of the product number; **Example:** S9GK-20-OHP. Half-Back add **\$197.46** list, Full-Back add **\$225.68** list.

Lounge Island Screen and Ganging Bracket

Island Screen

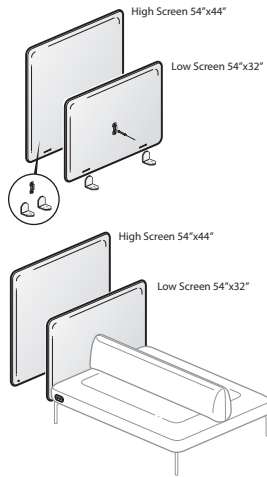

S9GS-L2
S9GS-H2

Features

- Includes one screen and attachment hardware.
- COM yardage: Low: 3.5/N/A High: 3.75/N/A

To Order, Specify:

- 1) Product number.
- 2) Fabric color.

Specification Tips

- Designed to provide privacy on one or both sides of the island.
- For use with Cabana Lounge Island only.
- Screen must be attached to a Cabana Lounge Island back for stability. This will require drilling a hole into the side edge of the island back for bracket attachment.

Description	Height from floor	Width	Number	Fabric Grade							
				A	B	C	D	E	F	G	H
Low	42"(1067mm)	54"(1372mm)	S9GS-L2	\$2221.47	\$2461.25	\$2595.24	\$2856.17	\$3032.50	\$3864.65	\$4365.36	\$5261.00
High	54"(1372mm)	54"(1372mm)	S9GS-H2	2221.47	2461.25	2595.24	2856.17	3032.50	3864.65	4365.36	5261.00

Island Screen Ganging Bracket

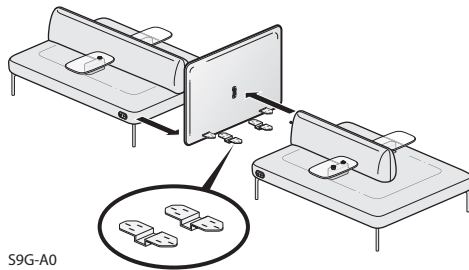

S9G-A0

Features

- Includes two brackets and screws.
- Used to gang Cabana Lounge Island with screen to a second Cabana Lounge Island.

To Order, Specify:

- 1) Product number.
(No finish specification required.)

Number	Price
S9G-A0	\$321.58

Accessories

Ganging Bracket

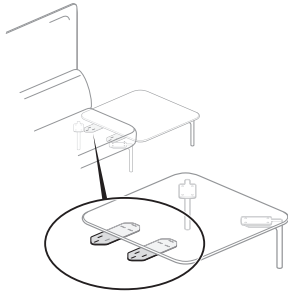

S9G-00

Features

- Includes two brackets and screws.
- Used to gang seating unit to seating unit or seating unit to table.
- Black only.

To Order, Specify:

- 1) Product number.
(No finish specification required.)

Specification Tips

- When ganging with screens, use Ganging Kit S9G-10.
- Remove table legs when ganging tables to seating.

Number	Price
S9G-00	\$204.52

Ganging Kit

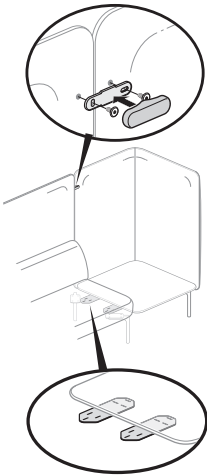

S9G-10

Features

- Includes two ganging brackets, one screen alignment clip with cover and hardware.
- Ganging bracket used to gang seating unit to seating unit or seating unit to table.
- Ganging brackets available in black only.
- Screen alignment clip used to connect two screens together.
- Screen alignment clip available in trim colors.

To Order, Specify:

- 1) Product number.
- 2) Screen alignment clip trim color.

Specification Tips

- Ganging kit used to gang Cabana seating with screen to other Cabana seating or tables with a screen.
- Remove table legs when ganging tables to seating.
- Screen accessories should not hang on screen intersection or screen alignment clip.

Number	Price
S9G-10	\$225.68

Accessories

Shelf

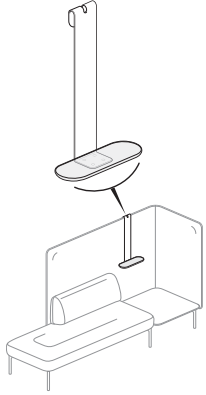

S9SL
Class CB
GSA: Open Market

Features

- Includes one painted MDF or planked wood shelf and one painted steel shelf hook.
- Shelf hook hangs over top of a Cabana screen.
- Maximum weight load is 5 lbs. centered.

To Order, Specify:

- 1) Product number.
- 2) Shelf material/color.
- 3) Trim color.

Specification Tips

- Best used on High Screens or placed over a table.
- Do not use on a screen intersection or screen alignment clip.

Description	Height	Depth	Width	Number	Price
Painted MDF	18"(457mm)	4"(102mm)	12"(305mm)	S9SL-P0	\$ 592.38
Plank White Oak				S9SL-W0	1847.69
Plank Walnut				S9SL-W0	2016.94

Coat Hook

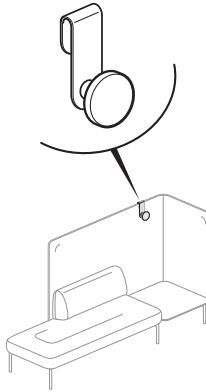

HOCH-0000
Class QA
SIN 33721
Discount Group IX

Features

- Includes one painted steel bracket and wood white oak disk hook.
- Maximum weight load is 10 lbs.

To Order, Specify:

- 1) Product number.
- 2) Trim color.

Specification Tips

- When used in a Cabana application the Coat Hook is best used on High Screens, on outside of screen or placed over a table.
- Do not use on a screen intersection or screen alignment clip.

Height	Depth	Width	Number	Price
7.7"(178mm)	1.6"(25mm)	3"(76mm)	HOCH-0000	\$252.47

Accessories

Connector Screen

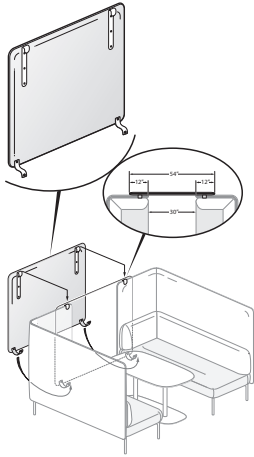

S9SH-20

Features

- Includes one connector screen with hanging brackets.
- Available in one height only. Height designed to match height of High Screen.
- Designed to connect two sofas with high screens together to form a booth application.
- Hanging brackets shipped installed.
- COM yardage: 3.5

To Order, Specify:

- 1) Product number.
- 2) Screen material.
- 3) Bracket color.

Specification Tip

- Recommend connected seating be placed 30”(762mm) apart.

Height from Floor	Depth	Width	Number	Fabric Grade							
				A	B	C	D	E	F	G	H
54”(1372mm)	2”(51mm)	54”(1372mm)	S9SH-20	\$2221.47	\$2644.61	\$2877.34	\$3328.68	\$3646.03	5098.80	\$5973.27	\$7538.87

Shelf with Monitor Mount

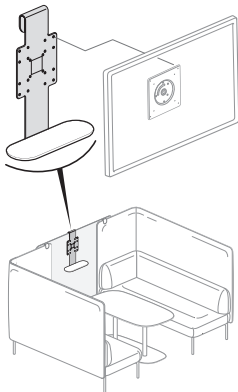

S9SP
S9SW

Features

- Includes one painted MDF or planked wood shelf, one painted steel shelf hook and one monitor mount.
- Shelf hook hangs over top of a Cabana Lounge Connector Screen.
- Maximum weight load is 40 lbs.
- Maximum monitor size is 32”(813mm).

To Order, Specify:

- 1) Product number.
- 2) Wood or paint finish.
- 3) Trim color.

Specification Tip

- Designed for use on Cabana Lounge Connector Screen only.

Description	Height	Depth	Width	Number	Price
Painted MDF	18”(457mm)	4”(102mm)	12”(305mm)	S9SP-M0	\$ 641.76
Plank White Oak				S9SW-M0	\$1897.07
Plank Walnut				S9SW-M0	\$2066.32

Bezel Utility Module

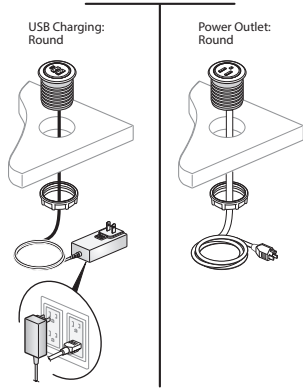

EURT-0072-1100
EURT-0072-1010



Features

- Includes: Round faced Power Module and mounting hardware.
- For use on surfaces 0.75”(19mm) - 1.44”(37mm) thick.
- Available with either:
 - One power outlet (NEMA 5-15R)
 - One two port USB charger. Consists of two USB outlets with 1000mA of charging power (5 volts) per USB outlet.
- Available in black or supplier white only.

To Order, Specify:

1) Product number, including:

1 Color Options:

- B** Black
- W** White

Specification Tips

- For use with **120 volt 60 hertz power source only**.
- Power configuration has one cord with plug (NEMA 5-15P).
- USB configuration has one cord with 2”(51mm) x 1”(25mm) x 3”(76mm) voltage transformer plug. Transformer may block adjacent outlets (see illustration).
- Requires field cut 1.75”(44mm) hole and field installation.
- Application may require approval of local authority having jurisdiction (AHJ); ensure compliance before placing orders and installing.

Description	Depth	Number	1	Price
6' Cord				
Power	1.75”(44mm)	EURT-0072-1100C		\$120.54
USB		EURT-0072-1010C		361.66
12' Cord				
Power	1.75”(44mm)	EURT-00E4-1100C		\$206.65
USB		EURT-00E4-1010C		447.77

Data Bezel

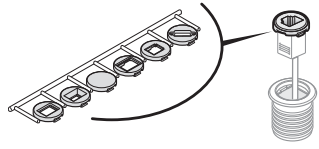

EURT-0000-N001CB
EURT-0000-N001CW

Description	Number	Price
Round		
Black	EURT-0000-N001CB	\$120.54
White	EURT-0000-N001CW	120.54

Feature

- Includes one round bezel for the Bezel Utility Module.
- Available in black or supplier white only.

To Order, Specify:

1) Product number.
(No finish specification required.)

Finish/Color Legend

Cabana Lounge Seating & Tables Trim Colors

TR-F	Black
TR-M1	Black Matte
TR-RR	Rusty Red
TR-1M	Sable
TR-PLS	Smooth Plaster
TR-M2	Smooth Plaster Matte

Painted MDF

PW-F	Black
PW-AK	Chalk
PW-PL	Polar
PW-SP	Stormy
PW-ST	Straw

Planked Wood

VB-W35	Plank White Oak
VH-W35	Plank Walnut

Laminate Grade A

Solid Color

H-34	Beige
H-AK	Chalk
H-8J	Charcoal
H-3J	Graphite
H-62	Gray Tone
H-WL	Linen
H-3P	Platinum
H-AA	Putty
H-3E	Smoke

Patterned

H-P1	Linen Casual
H-P2	Linen Classic
H-P3	Linen Crisp
H-P4	Linen Flax

Wood Grain

H-AE	Maple
------	-------

Grade B

Premium Wood Grain

H-KA	Brazilwood
H-KG	Columbian Walnut
H-KP	Field Elm
H-KN	Grey Elm
H-KM	Landmark Wood
H-KL	Neo Walnut
H-KC	New Age Oak
H-KR	Phantom Ecru
H-KS	Phantom Pearl
H-KD	River Cherry
H-KF	Williamsburg Cherry

Edgeband

Solid Color

HP-34	Beige
HP-AK	Chalk
HP-8J	Charcoal
HP-3J	Graphite
HP-62	Gray Tone
HP-WL	Linen
HP-3P	Platinum
HP-AA	Putty
HP-3E	Smoke

Patterned Edgeband

HP-P1	Linen Casual
HP-P2	Linen Classic
HP-P3	Linen Crisp
HP-P4	Linen Flax

Wood Grain

HP-KA	Brazilwood
HP-KG	Columbian Walnut
HP-KP	Field Elm
HP-KN	Grey Elm
HP-KM	Landmark Wood
HP-AE	Maple
HP-KL	Neo Walnut
HP-KC	New Age Oak
HP-KR	Phantom Ecru
HP-KS	Phantom Pearl
HP-KD	River Cherry
HP-KF	Williamsburg Cherry

Ply-Edge

HP-PW	Ply-Edge
-------	----------

Wood Finishes

Grade A

Double Cut

WE-RD	Dune
WJ-RE	Ebony
2N-RL	Echo
W3-HR	Harbor
WE-RT	Melba
W4-PB	Pebble
CQ-WG	Walnut Grove

Grade B

Cherry

VC-CA1	Amber
VC-W23	American
VC-W33	Caramel
VC-W30	Heritage
VC-W32	Pacific

Maple

VP-LM	Light
VP-N	Natural

Maple Quarter Cut

NM-N	Natural
------	---------

Rift Cut White Oak

NR-W35	Clear
NR-W15	Espresso
NR-W40	Mocha

Walnut

VR-W15	Espresso
VR-W31	Retro

Walnut Quarter Cut

NW-W35	Clear
NW-W15	Espresso
NW-W31	Retro

ALERT: These materials are current, however they are being considered for future obsolescence due to low volume.

Wood:

WL-RL	Beachwood
VJ-W42	Brindle
2R-RL	Butternut
NP-W08	Golden
NP-W07	Light
NX-U	Medium
VJ-W05	Natural
VR-W12	Naturally Walnut
VP-AD	Sand
WC-RW	Wenge

Laminate:

H-AM	Amber Cherry
H-AD	Medium Cherry

Edgeband:

HP-AM	Amber Cherry
HP-AD	Medium Cherry

Trims:

TR-1E	Accent Orange
TR-1F	Accent Red
TR-AR	Argent
TR-CTS	Chartreuse
TR-DM	Dark Bronze Metallic
TR-1H	Terra
TR-1K	Wren

Forest Stewardship Council®

(FSC®) Statement: In our continuing support of sustainable forestry and responsible purchasing, Haworth North America is offering FSC certified wood products at no up-charge. By providing FSC certified material, Haworth is supporting our client's green building goals and demonstrating our collective commitment to source materials more sustainably.

Haworth will provide to you the necessary FSC-certified paperwork with your shipment. For more information, FAQs, and a complete FSC product list (including product exceptions), go to the Library and search FSC.

Haworth FSC Trademark License
#FSC-C002821

Fabrics/Color Legend

Haworth seating models are restricted to fabric patterns that meet applicability standards for tailoring. A dot in the matrix below indicates fabric acceptability on seating series or specific models listed. Fabrics are listed alphabetically by grade.

Grade: Pattern (Surface Code)	Model	
	Seating	Screens
Fabrics		
A: Blanket (4H)	●	●
A: Hobson (3J)	●	●
A: Morse (4J)	●	
A: Novelty (3L)	●	●
B: Element (4Z)	●	●
B: Ramie (4V)	●	●
C: Dots (6K)	●	●
C: King II (67)	●	●
C: Maya II (68)	●	●
C: Oceanic (4T)	●	●
C: Scapes (3S)	●	●
D: Atlas by Kvadrat (LW)	●	●
D: Big Arrow (4D)	●	●
D: Big Diagonale (1K)	●	●
D: Clara 2 by Kvadrat (NV)	●	●
D: Class II (66)	●	●
D: Main Line Flax (6M)	●	●
D: Melange Nap by Kvadrat (S7)	●	●
F: Divina Melange 3 by Kvadrat (SV)	●	●
F: Hallingdal 65 by Kvadrat (SZ)	●	●

Haworth+

For information on the Haworth+ alliance program, including images and product availability, please refer to:
[Haworth.com > Surface Collection > Haworth+ Library](#)

Customer's Own Material (COM)

For general Customer's Own Material (COM) information including processes and forms, please refer to:
[Haworth.com > Surface Collection > Resources > COM](#)
 For information on approved COM's, please refer to:
[Haworth.com > Surface Collection > COM Library](#)

* For most current finish and fabric availability please reference [surfaces.haworth.com](#).

COM Yardage Requirements

Procedure

To determine if a COM fabric has been approved for use on Haworth product, contact the Haworth Inquiry Center (1.800.426.8562), your local Haworth dealer, or go to surfaces.haworth.com > COM Library. Haworth will calculate and order fabric unless instructed otherwise. If the dealer is to provide the fabric, they will calculate the yardage needed themselves.

If the fabric is approved, and the directional orientation (directional rightway, directional railroad, or non-directional) of the tested fabric has been confirmed, then refer to the appropriate price page for yardage requirements.

COM Fabric Requirements

The fabric yardage requirements for COMs given for each model are in lineal yards and are based on 54"(1372mm) usable fabric widths. Approximate yardage requirements are shown for each model within the price pages.

For fabrics already approved, with a COM order entry code assigned, Haworth will determine and purchase the yardage needed. If the fabric will be provided by the dealer, and the pattern has a large repeat or stripes, additional yardage will be needed; contact the COM Department for more information.

Find total number of linear yards required for the order. Add the appropriate percentage shown below to the total yardage to accommodate fabric flaws, wrinkles and other imperfections.

Up to 500 yards	Add 10%
501 to 1000 yards	Add 5%
More than 1000 yards	Add 3%

Directional Rightway:

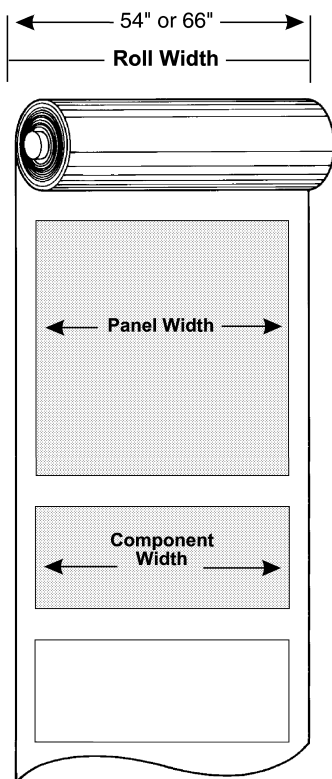

Directional Railroad:

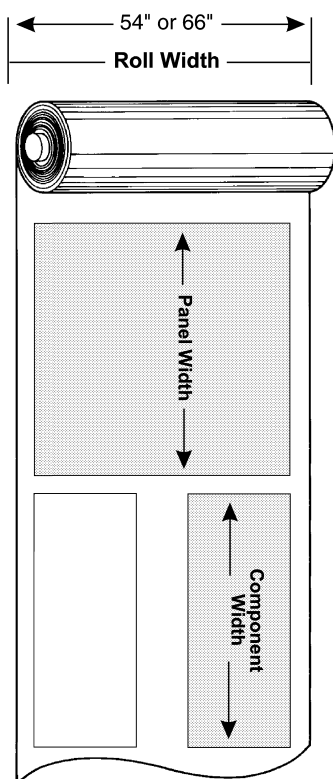

Non-Directional:

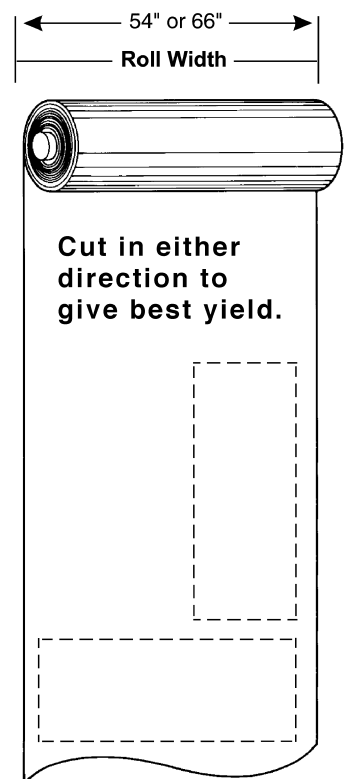

Index

Products are listed alphabetically in this index by alpha-numeric prefix/suffix codes.

Product Code	Product Description	Page
EURT-0000-N001CB	Bezel Utility Module – Data Bezel	.46
EURT-0000-N001CW	Bezel Utility Module – Data Bezel	.46
EURT-0072-1010	Bezel Utility Module – Bezel Utility Module	.46
EURT-0072-1100	Bezel Utility Module – Bezel Utility Module	.46
HOCH-0000	Accessories – Coat Hook	.44
S910	Tables – Square	.22
S914	Tables – Square	.22
S920	Tables – Square Tiered	.24
S924	Tables – Square Tiered	.24
S930	Tables – Rectangle	.26
S934	Tables – Rectangle	.26
S940	Tables – Rectangle Tiered	.28
S944	Tables – Rectangle Tiered	.28
S950	Tables – Wedge	.30
S956	Tables – Wedge	.30
S960	Tables – Wedge Tiered	.32
S966	Tables – Wedge Tiered	.32
S9AL-0	Corner Sofa – Corner Sofa	.12
S9AL-H	Corner Sofa – Corner Sofa	.12
S9AL-L	Corner Sofa – Corner Sofa	.12
S9B0-0	Single Seat Sofa – Single Seat Sofa	.14
S9BB-0	Single Seat Sofa – Single Seat Sofa	.14
S9BL-0	Single Seat Sofa – Single Seat Sofa	.14
S9BL-L	Single Seat Sofa – Single Seat Sofa	.14
S9BR-0	Single Seat Sofa – Single Seat Sofa	.14
S9BR-H	Single Seat Sofa – Single Seat Sofa	.14
S9C0-0	Two-Seat Collaborative Sofa – Two-Seat Collaborative Sofa	.17
S9C2-0	Two-Seat Collaborative Sofa – Two-Seat Collaborative Sofa	.17
S9C2-H	Two-Seat Collaborative Sofa – Two-Seat Collaborative Sofa	.17
S9CB-0	Two-Seat Collaborative Sofa – Two-Seat Collaborative Sofa	.17
S9CB-0	Two-Seat Collaborative Sofa – Two-Seat Collaborative Sofa	.17
S9CH-0	Two-Seat Collaborative Sofa – Two-Seat Collaborative Sofa	.17
S9CL-0	Two-Seat Collaborative Sofa – Two-Seat Collaborative Sofa	.17
S9CL-0	Two-Seat Collaborative Sofa – Two-Seat Collaborative Sofa	.17
S9CL-L	Two-Seat Collaborative Sofa – Two-Seat Collaborative Sofa	.17
S9CR-0	Two-Seat Collaborative Sofa – Two-Seat Collaborative Sofa	.17
S9CR-H	Two-Seat Collaborative Sofa – Two-Seat Collaborative Sofa	.17
S9CZ-0	Two-Seat Collaborative Sofa – Two-Seat Collaborative Sofa	.17
S9DC-0	Chaise Lounge – Chaise Lounge	.20
S9DC-H	Chaise Lounge – Chaise Lounge	.20
S9DT-0	Chaise Lounge – Chaise Lounge	.20
S9DT-L	Chaise Lounge – Chaise Lounge	.20
S9EL	Chaise Lounge Retreat – Chaise Lounge Retreat	.34
S9F	Half-Back Sofa Retreat – Half-Back Sofa Retreat	.37
S9G-00	Accessories – Ganging Bracket	.43
S9G-10	Accessories – Ganging Kit	.43
S9G-A0	Lounge Island Screen and Ganging Bracket – Island Screen Ganging Bracket	.42

Index

<u>Product Code</u>	<u>Product Description</u>	<u>Page</u>
S9GB-2_OH	Lounge Island – Lounge Island40
S9GB-2_PH	Lounge Island – Lounge Island40
S9GK-2_OH	Lounge Island – Lounge Island40
S9GK-2_PH	Lounge Island – Lounge Island40
S9GS-H2	Lounge Island Screen and Ganging Bracket – Island Screen42
S9GS-L2	Lounge Island Screen and Ganging Bracket – Island Screen42
S9L2-0	Individual Lounge – Individual Lounge11
S9L2-H	Individual Lounge – Individual Lounge11
S9L2-L	Individual Lounge – Individual Lounge11
S9SH-20	Accessories – Connector Screen45
S9SL	Accessories – Shelf44
S9SP	Accessories – Shelf with Monitor Mount45
S9SW	Accessories – Shelf with Monitor Mount45

Index

<u>Product Code</u>	<u>Product Description</u>	<u>Page</u>
S9L2-0	Individual Lounge11
S9L2-H	Individual Lounge11
S9L2-L	Individual Lounge11
S9SL	Accessories – Shelf41

This page intentionally blank

Product Compatibility and Limited Warranty Policy

Great Expectations

You have them as a Haworth customer and so do we. And because we value our customers, we cover our products with the Haworth North America Product Compatibility and Limited Warranty Policy.

Our Commitment To Product Compatibility – Integrated Product Platforms

As a market leader in the design and manufacture of workspaces that adapt to change, we strive to maintain product compatibility within our various generations of integrated product platforms. This benefits the customer who desires to update or modify their work environment. It also benefits the customer needing to replace a product due to damage or other reasons but which is no longer manufactured or is otherwise unavailable, such as a fabric or finish that is discontinued because of changing market preferences. In both circumstances, we often can provide products with comparable function and performance.

Our Commitment To Product Quality – The Haworth North America Limited Warranty

To ensure customer satisfaction and peace of mind, we stand behind our products with the Haworth North America Limited Warranty. To review the current version of the limited warranty including its terms and conditions, please go to:

www.haworth.com/warranty or contact OneTouch@Haworth.com or 1 877 429 6784.

Warranty Requests or Questions

For questions or service requests pertaining to the Haworth Limited Warranty, please contact your Haworth dealer.

If you are unsure who your dealer is, please contact **OneTouch@Haworth.com or 1 877 429 6784.**

Effective: September 1, 2021

Terms of Sale

The Terms of Sale apply to all products in the North America Price Lists. To review the current version of the North American Terms of Sale, please go to:

www.haworth.com/terms-of-sale or contact OneTouch@Haworth.com or 1 877 429 6784.

Effective: September 2, 2022

HAWORTH

HAWORTH® is a registered trademark of Haworth, Inc.
© Haworth, Inc. All rights reserved. 2024 2.24 | Item #LIT21009
haworth.com | 800 344 2600