

# LIBRARY SHELVING

S H E L V I N G   &   D I S P L A Y   S Y S T E M S



# INTRODUCTION

For over thirty years, Spacesaver has been a leader in the storage industry, earning over one hundred patents and thousands of satisfied customers along the way. Today, thousands of libraries around the world rely on us for consistent quality, shelf after shelf, frame after frame. Whether your school is a college or university, public or private, K-12 or special needs, we have the experience to respond creatively and comprehensively to your library's needs. Today, you need to shelve media, and also display and merchandise it. As such, we are continually expanding our line of specialty shelves and accessories, keeping up with the demands of today and tomorrow. At some point you may need to reconfigure – that's where Spacesaver Library Shelving products really pay dividends. Every shelf, frame and accessory is manufactured to the strictest standards, ensuring simple reassembly. In addition, Spacesaver shelving is designed to achieve maximum capacity in both static and mobile configurations.

## TABLE OF CONTENTS

## PAGE

|                              |       |
|------------------------------|-------|
| Frames & Supports . . . . .  | 4-5   |
| Base Shelves . . . . .       | 6     |
| Adjustable Shelves . . . . . | 6-7   |
| Specialty Shelves . . . . .  | 7-8   |
| Accessories . . . . .        | 9-10  |
| Options . . . . .            | 10-12 |

# PLANNING CANTILEVER SHELVING

## MOBILE GUSSETED UNITS (For use on Spacesaver mobile carriages)

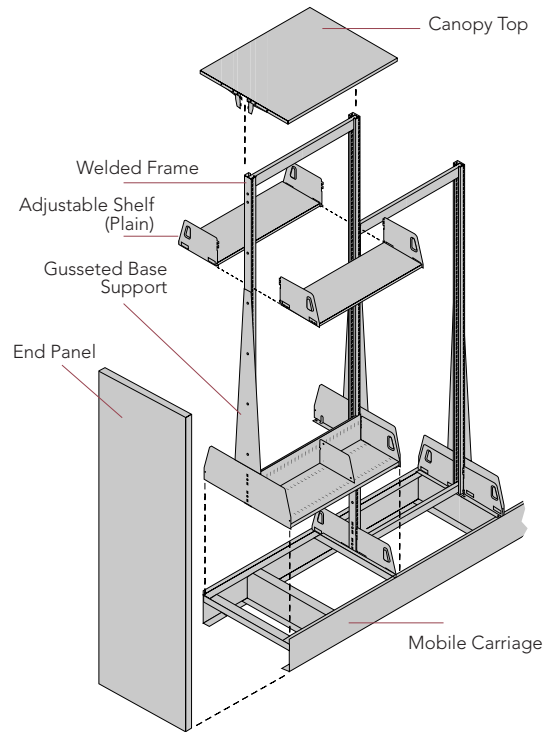

### ACTUAL vs. NOMINAL DIMENSIONS

All shelf depth dimensions in the catalog number are actual. For library nominal dimensions, add 1" to the actual depth. See diagram below.

### SINGLE FACE & DOUBLE FACE PLAN VIEW DIMENSIONS

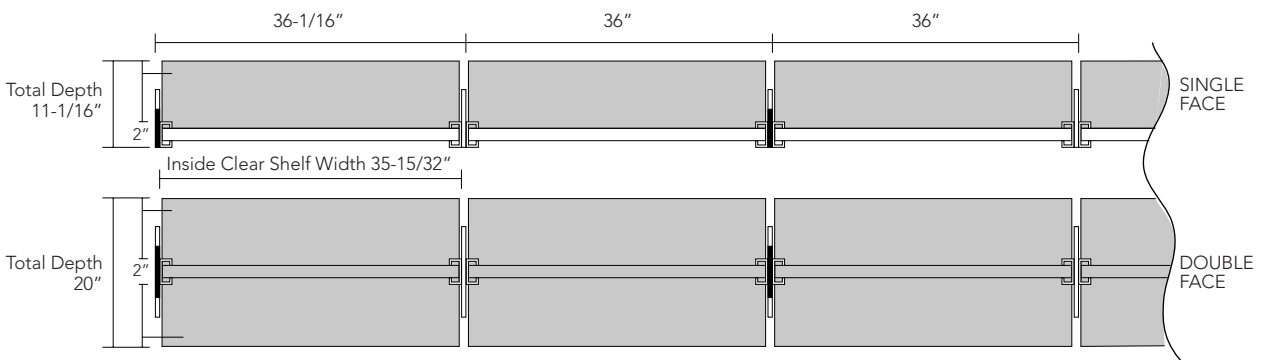

# FRAMES & SUPPORTS

## WELDED FRAMES

Accepts all shelves and accessory items. Adjustable on 1" increments.  
No sway braces to inhibit oversized media from passing center line of bookstack.

| Frame Height | Catalog No.* |
|--------------|--------------|
| 42"          | CWF-4236     |
| 66"          | CWF-6636     |
| 78"          | CWF-7836     |
| 84"          | CWF-8436     |
| 90"          | CWF-9036     |

NOTES: \*24", 30" and 33.7" widths are available. Change the catalog number accordingly, e.g.:CWF-8430. Consult factory for special heights.

## SEISMIC WELDED FRAMES

Accepts all shelves and accessory items. Adjustable on 1" increments.  
May be adapted to meet all seismic requirements.\*

| Frame Height | Catalog No.** |
|--------------|---------------|
| 78"          | CWF3-7836     |
| 84"          | CWF3-8436     |
| 90"          | CWF3-9036     |

NOTES: \*Additional horizontal spreaders available.  
\*\*24", 30" and 33.7" widths are available. Change the catalog number accordingly, e.g.:CWF3-8430. Consult factory for special heights.

## BASE SUPPORTS

Single face base supports must be specified left or right.

### SINGLE FACE

| Overall Support Depth | Left End Catalog No.* | Right End Catalog No.* |
|-----------------------|-----------------------|------------------------|
| 8"                    | CSB-6L                | CSB-6R                 |
| 9"                    | CSB-7L                | CSB-7R                 |
| 10"                   | CSB-8L                | CSB-8R                 |
| 11"                   | CSB-9L                | CSB-9R                 |
| 12"                   | CSB-10L               | CSB-10R                |
| 13"                   | CSB-11L               | CSB-11R                |
| 14"                   | CSB-12L               | CSB-12R                |
| 15"                   | CSB-13L               | CSB-13R                |
| 16"                   | CSB-14L               | CSB-14R                |
| 17"                   | CSB-15L               | CSB-15R                |
| 20"                   | CSB-18L               | CSB-18R                |

### DOUBLE FACE

| Overall Support Depth | Catalog No.* | Overall Support Depth | Catalog No.* |
|-----------------------|--------------|-----------------------|--------------|
| 14"                   | CDB-6        | 26"                   | CDB-12       |
| 16"                   | CDB-7        | 28"                   | CDB-13       |
| 18"                   | CDB-8        | 30"                   | CDB-14       |
| 20"                   | CDB-9        | 32"                   | CDB-15       |
| 22"                   | CDB-10       | 38"                   | CDB-18       |
| 24"                   | CDB-11       |                       |              |

NOTE: \*Catalog number corresponds to actual depth of Base Shelf used.

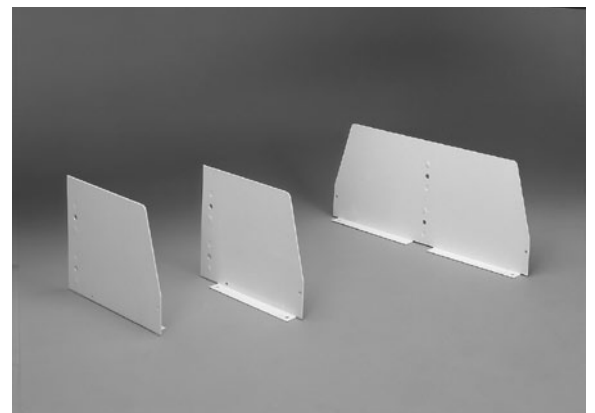
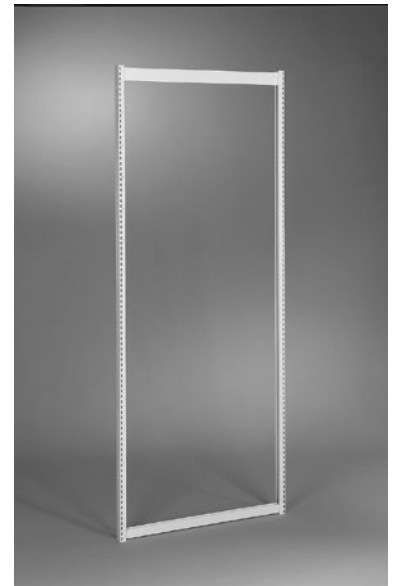

# FRAMES & SUPPORTS (continued)

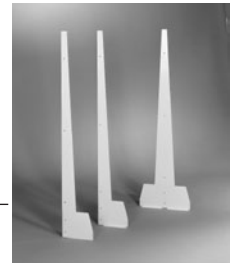

## GUSSETED BASE SUPPORTS

For use in seismic and/or mobile shelving applications. Specify single face base supports left or right.

### SINGLE FACE: 70" THRU 90" HIGH FRAMES

| Overall Support Depth | Left End Catalog No.* | Right End Catalog No.* |
|-----------------------|-----------------------|------------------------|
| 8"                    | CSBG-6L               | CSBG-6R                |
| 9"                    | CSBG-7L               | CSBG-7R                |
| 10"                   | CSBG-8L               | CSBG-8R                |
| 11"                   | CSBG-9L               | CSBG-9R                |
| 12"                   | CSBG-10L              | CSBG-10R               |
| 13"                   | CSBG-11L              | CSBG-11R               |
| 14"                   | CSBG-12L              | CSBG-12R               |
| 15"                   | CSBG-13L              | CSBG-13R               |
| 17"                   | CSBG-15L              | CSBG-15R               |
| 20"                   | CSBG-18L              | CSBG-18R               |

### SINGLE FACE: 46" THRU 57" HIGH FRAMES

| Overall Support Depth | Left End Catalog No.* | Right End Catalog No.* |
|-----------------------|-----------------------|------------------------|
| 8"                    | CSBG-6L46             | CSBG-6R46              |
| 9"                    | CSBG-7L46             | CSBG-7R46              |
| 10"                   | CSBG-8L46             | CSBG-8R46              |
| 11"                   | CSBG-9L46             | CSBG-9R46              |
| 12"                   | CSBG-10L46            | CSBG-10R46             |
| 13"                   | CSBG-11L46            | CSBG-11R46             |
| 14"                   | CSBG-12L46            | CSBG-12R46             |
| 15"                   | CSBG-13L46            | CSBG-13R46             |
| 17"                   | CSBG-15L46            | CSBG-15R46             |
| 20"                   | CSBG-18L46            | CSBG-18R46             |

### SINGLE FACE: 58" THRU 69" HIGH FRAMES

| Overall Support Depth | Left End Catalog No.* | Right End Catalog No.* |
|-----------------------|-----------------------|------------------------|
| 8"                    | CSBG-6L58             | CSBG-6R58              |
| 9"                    | CSBG-7L58             | CSBG-7R58              |
| 10"                   | CSBG-8L58             | CSBG-8R58              |
| 11"                   | CSBG-9L58             | CSBG-9R58              |
| 12"                   | CSBG-10L58            | CSBG-10R58             |
| 13"                   | CSBG-11L58            | CSBG-11R58             |
| 14"                   | CSBG-12L58            | CSBG-12R58             |
| 15"                   | CSBG-13L58            | CSBG-13R58             |
| 17"                   | CSBG-15L58            | CSBG-15R58             |
| 20"                   | CSBG-18L58            | CSBG-18R58             |

NOTE: \*Catalog number corresponds to actual depth of Base Shelf used.

## TRANSVERSE OVERHEAD TIE STRUTS

For extra stabilization overhead when local conditions or regulations require.

| Strut Length         | Catalog No. |
|----------------------|-------------|
| 96"                  | CTTS-96     |
| 120"                 | CTTS-120    |
| Wall Anchor Bracket* | CTSWA       |
| Splice Kit*          | CTTS-SK     |



NOTE: Includes hardware.

### DOUBLE FACE: 70" THRU 90" HIGH FRAMES

| Overall Support Depth | Catalog No.* |
|-----------------------|--------------|
| 14"                   | CDBG-6       |
| 16"                   | CDBG-7       |
| 18"                   | CDBG-8       |
| 20"                   | CDBG-9       |
| 22"                   | CDBG-10      |
| 24"                   | CDBG-11      |
| 26"                   | CDBG-12      |
| 28"                   | CDBG-13      |
| 32"                   | CDBG-15      |
| 38"                   | CDBG-18      |

### DOUBLE FACE: 46" THRU 57" HIGH FRAMES

| Overall Support Depth | Catalog No.* |
|-----------------------|--------------|
| 14"                   | CDBG-646     |
| 16"                   | CDBG-746     |
| 18"                   | CDBG-846     |
| 20"                   | CDBG-946     |
| 22"                   | CDBG-1046    |
| 24"                   | CDBG-1146    |
| 26"                   | CDBG-1246    |
| 28"                   | CDBG-1346    |
| 32"                   | CDBG-1546    |
| 38"                   | CDBG-1846    |

### DOUBLE FACE: 58" THRU 69" HIGH FRAMES

| Overall Support Depth | Catalog No.* |
|-----------------------|--------------|
| 14"                   | CDBG-658     |
| 16"                   | CDBG-758     |
| 18"                   | CDBG-858     |
| 20"                   | CDBG-958     |
| 22"                   | CDBG-1058    |
| 24"                   | CDBG-1158    |
| 26"                   | CDBG-1258    |
| 28"                   | CDBG-1358    |
| 32"                   | CDBG-1558    |
| 38"                   | CDBG-1858    |

## WALL COLUMN SUPPORTS

Shelves/accessory components easily be attached to Wall Column Supports for wall-mounted installations\*. Column width and depth: 2-3/4" wide x 3/4" deep.

| Column Height | Catalog No.* | Column Height | Catalog No.* |
|---------------|--------------|---------------|--------------|
| 42"           | CWFC-42      | 84"           | CWFC-84      |
| 66"           | CWFC-66      | 90"           | CWFC-90      |
| 78"           | CWFC-78      |               |              |

NOTES: \*If Canopy Tops are desired for use with Wall Column Supports, consult factory. Special heights available. Recommended for concrete or brick walls. To be anchored with the appropriate hardware supplied by the installer for the specific wall material.



# BASE SHELVES

Base Shelves include End Brackets. Standard widths of 36", 24" and 30" are available. Change the catalog number accordingly, e.g., CBSPB-2411. If 1" nominal "Base Shelves" are desired, see below for Adjustable Shelves.

## 3" BASE SHELVES\*

3" Base Shelves position media clear of brooms and floor mops.

| Actual Shelf Depth | Catalog No. |
|--------------------|-------------|
| 6"                 | CBSPB-3606  |
| 7"                 | CBSPB-3607  |
| 8"                 | CBSPB-3608  |
| 9"                 | CBSPB-3609  |
| 10"                | CBSPB-3610  |
| 11"                | CBSPB-3611  |
| 12"                | CBSPB-3612  |
| 13"                | CBSPB-3613  |
| 15"                | CBSPB-3615  |

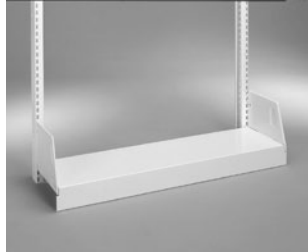

## 3" BASE SHELVES w/INTEGRAL LOW-BACK\*

Integral Low-Back Shelves are compatible with Integral Low-Back Dividers.

| Actual Shelf Depth | Catalog No. |
|--------------------|-------------|
| 6"                 | CLBBSB-3606 |
| 7"                 | CLBBSB-3607 |
| 8"                 | CLBBSB-3608 |
| 9"                 | CLBBSB-3609 |
| 10"                | CLBBSB-3610 |
| 11"                | CLBBSB-3611 |
| 12"                | CLBBSB-3612 |
| 15"                | CLBBSB-3615 |

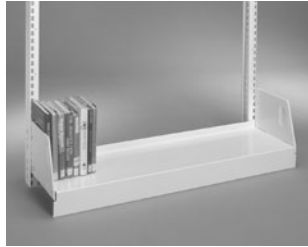

NOTE: Integral Low-Back Dividers (Catalog No. CLBDxx) sold separately. See page 9 for corresponding Integral Low-Back Dividers.

## 3" SLOTTED BASE SHELVES\*

Slotted on 1" centers for Dividers. Includes Slotted Backstop.

| Actual Shelf Depth | Catalog No. |
|--------------------|-------------|
| 6"                 | CBSSB-3606  |
| 7"                 | CBSSB-3607  |
| 8"                 | CBSSB-3608  |
| 9"                 | CBSSB-3609  |
| 10"                | CBSSB-3610  |
| 11"                | CBSSB-3611  |
| 12"                | CBSSB-3612  |
| 15"                | CBSSB-3615  |

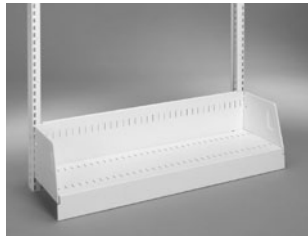

NOTE: Dividers sold separately. See page 8.

## 3" SLOPED PLAIN BASE SHELVES\*

Sloped to aid viewing of items on the bottom shelf.

| Actual Shelf Depth | Catalog No.  |
|--------------------|--------------|
| 6"                 | CBSPB-3606SL |
| 7"                 | CBSPB-3607SL |
| 8"                 | CBSPB-3608SL |
| 9"                 | CBSPB-3609SL |
| 10"                | CBSPB-3610SL |
| 11"                | CBSPB-3611SL |
| 12"                | CBSPB-3612SL |
| 15"                | CBSPB-3615SL |

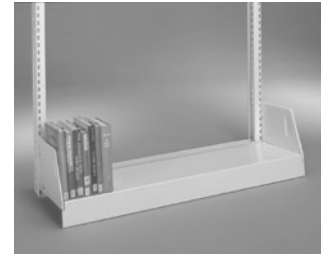

NOTE: If End Panels are used with Sloped Base Shelf, consult factory for End Panel dimension.

## 3" SLOPED BASE SHELVES w/INTEGRAL LOW-BACK\*

Sloped to aid viewing of items on the bottom shelf. Compatible with Integral Low-Back Dividers.

| Actual Shelf Depth | Catalog No.   |
|--------------------|---------------|
| 6"                 | CLBBSB-3606SL |
| 7"                 | CLBBSB-3607SL |
| 8"                 | CLBBSB-3608SL |
| 9"                 | CLBBSB-3609SL |
| 10"                | CLBBSB-3610SL |
| 11"                | CLBBSB-3611SL |
| 12"                | CLBBSB-3612SL |
| 15"                | CLBBSB-3615SL |

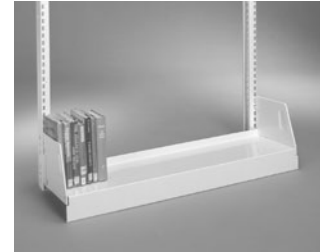

NOTE: Integral Low-Back Dividers (Catalog No. CLBDxx) sold separately. See page 9 for corresponding Integral Low-Back Dividers. If End Panels are used with Sloped Base Shelf, consult factory for End Panel dimension.

## 3" SLOPED SLOTTED BASE SHELVES\*

Slotted on 1" centers for Dividers. Sloped to aid viewing of items on the bottom shelf. Includes Slotted Backstop.

| Actual Shelf Depth | Catalog No.  |
|--------------------|--------------|
| 6"                 | CBSSB-3606SL |
| 7"                 | CBSSB-3607SL |
| 8"                 | CBSSB-3608SL |
| 9"                 | CBSSB-3609SL |
| 10"                | CBSSB-3610SL |
| 11"                | CBSSB-3611SL |
| 12"                | CBSSB-3612SL |
| 15"                | CBSSB-3615SL |



NOTES: Dividers sold separately. See page 8. If End Panels are used with Sloped Base Shelf, consult factory for End Panel dimension.

# ADJUSTABLE SHELVES

Adjustable shelves are available in 24" and 30" widths.

## PLAIN ADJUSTABLE SHELVES\*

All shelves include End Brackets.

| Actual Shelf Depth | Catalog No. |
|--------------------|-------------|
| 6"                 | CSPB-3606   |
| 7"                 | CSPB-3607   |
| 8"                 | CSPB-3608   |
| 9"                 | CSPB-3609   |
| 10"                | CSPB-3610   |
| 11"                | CSPB-3611   |
| 12"                | CSPB-3612   |
| 13"                | CSPB-3613   |
| 15"                | CSPB-3615   |



## ADJUSTABLE SHELVES w/INTEGRAL LOW-BACK\*

Integral Low-Back Shelves are compatible with Integral Low-Back Dividers.

| Actual Shelf Depth | Catalog No. |
|--------------------|-------------|
| 6"                 | CLBSB-3606  |
| 7"                 | CLBSB-3607  |
| 8"                 | CLBSB-3608  |
| 9"                 | CLBSB-3609  |
| 10"                | CLBSB-3610  |
| 11"                | CLBSB-3611  |
| 12"                | CLBSB-3612  |
| 15"                | CLBSB-3615  |



NOTE: Integral Low-Back Dividers (Catalog No. CLBDxx) sold separately. See page 9 for corresponding Integral Low-Back Dividers.

# ADJUSTABLE SHELVES (continued)

Shelves include End Brackets. 24" and 30" shelf widths are available. Change the catalog number accordingly. e.g., CSPB-2410. Adjustable Shelves may be used as Base Shelves in conjunction with Adjustable Kick Plates.

## SLOTTED ADJUSTABLE SHELVES\*

Slotted on 1" centers for Dividers.  
Includes Slotted Backstop.

| Actual Shelf Depth | Catalog No. |
|--------------------|-------------|
| 6"                 | CSSB-3606   |
| 7"                 | CSSB-3607   |
| 8"                 | CSSB-3608   |
| 9"                 | CSSB-3609   |
| 10"                | CSSB-3610   |
| 11"                | CSSB-3611   |
| 12"                | CSSB-3612   |
| 15"                | CSSB-3615   |



NOTE: Dividers sold separately. For Dividers, see page 8.  
Change dash (-) to "N" for narrow backstop when using a reference shelf.

## SLOPED PLAIN ADJUSTABLE SHELVES\*

Sloped for easier viewing of displayed items.

| Actual Shelf Depth | Catalog No. |
|--------------------|-------------|
| 6"                 | CSPB-3606SL |
| 7"                 | CSPB-3607SL |
| 8"                 | CSPB-3608SL |
| 9"                 | CSPB-3609SL |
| 10"                | CSPB-3610SL |
| 11"                | CSPB-3611SL |
| 12"                | CSPB-3612SL |
| 15"                | CSPB-3615SL |



NOTE: If End Panels are used with Sloped Shelf, consult factory for End Panel dimension.

## SLOPED ADJUSTABLE SHELVES w/INTEGRAL LOW BACK\*

Sloped to aid viewing of displayed items.  
Integral Low-Back Shelves are compatible with Integral Low-Back Dividers.

| Actual Shelf Depth | Catalog No.  |
|--------------------|--------------|
| 6"                 | CLBSB-3606SL |
| 7"                 | CLBSB-3607SL |
| 8"                 | CLBSB-3608SL |
| 9"                 | CLBSB-3609SL |
| 10"                | CLBSB-3610SL |
| 11"                | CLBSB-3611SL |
| 12"                | CLBSB-3612SL |
| 15"                | CLBSB-3615SL |



NOTE: Integral Low-Back Dividers (Catalog No. CLBDxx) sold separately. See page 9 for corresponding Integral Low-Back Divider. If End Panels are used with Sloped Shelf, consult factory for End Panel dimension.

## SLOPED SLOTTED ADJUSTABLE SHELVES\*

Sloped to aid viewing of displayed items. Includes Slotted Backstop.

| Actual Shelf Depth | Catalog No. |
|--------------------|-------------|
| 6"                 | CSSB-3606SL |
| 7"                 | CSSB-3607SL |
| 8"                 | CSSB-3608SL |
| 9"                 | CSSB-3609SL |
| 10"                | CSSB-3610SL |
| 11"                | CSSB-3611SL |
| 12"                | CSSB-3612SL |
| 15"                | CSSB-3615SL |

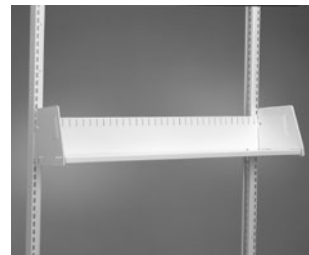

NOTE: Dividers sold separately. For Dividers, see page 8. If End Panels are used with Sloped Shelf, consult factory for End Panel dimension.

# SPECIALTY SHELVES

## PERIODICAL DISPLAY SHELF (HINGED)\*

Sloped display surface (with no exposed fasteners) is 14" high.  
Flat storage shelf is 12" deep.

| Actual Shelf Depth/Display | Catalog No. |
|----------------------------|-------------|
| 12"/14"                    | CHPD3612    |
| 12"/14"                    | CHPD33612   |

(Special 3" Base)



NOTE: The vertical opening between the flat shelf and the hinged display shelf (in the open position) is 6" clear. Recommend minimum 14" vertical center-to-center spacing.  
Front retaining lip is 1" deep.

## FIXED DISPLAY SHELF\*

11" high, sloped display surface for merchandising of books, tapes and periodicals.

| Actual Shelf Depth | Front Up Size | Catalog No. |
|--------------------|---------------|-------------|
| 11"                | 1"            | CFPS1-3611  |
| 11"                | 2"            | CFPS2-3611  |
| 11"                | 3"            | CFPS3-3611  |



NOTE: Recommend minimum 11" vertical center-to-center spacing.

## PERIODICAL DISPLAY SHELF (HINGED) WITH PLEXIGLAS COVERS

Sloped display is 14" high. Flat storage shelf is 12" deep.

| Actual Shelf Depth/Display | Catalog No. |
|----------------------------|-------------|
| 12"/14"                    | CHPSC-3612* |
| 12"/14"                    | CHPSC3-3612 |

(Special 3" Base)



NOTE: The vertical opening between the flat shelf and the hinged display shelf (in the open position) is 6" clear. Recommend minimum 14" vertical center-to-center spacing.  
Front retaining lip is 1" deep.

## FLAT STORAGE SHELF\*

Includes End Brackets. Can be used for storage under the Fixed Display Shelf.

| Actual Shelf Depth | Catalog No. |
|--------------------|-------------|
| 11"                | CFSSB3611   |
| 12"                | CFSSB3612   |
| 15"                | CFSSB3615   |



# SPECIALTY SHELVES (continued)

## PULL-OUT REFERENCE SHELF

For convenient referencing. Pull-Out Reference Shelf has a 50 lb. load capacity.

| Actual Reference Shelf Width/Depth | To Be Used With Shelf Depth | Catalog No.  |
|------------------------------------|-----------------------------|--------------|
| 32"/9"                             | 8"                          | CSRS-3609-08 |
| 32"/9"                             | 9"                          | CSRS-3609-09 |
| 32"/11"                            | 10"                         | CSRS-3611-10 |
| 32"/11"                            | 11"                         | CSRS-3611-11 |
| 32"/11"                            | 12"                         | CSRS-3611-12 |
| 32"/11"                            | 15"                         | CSRS-3611-15 |

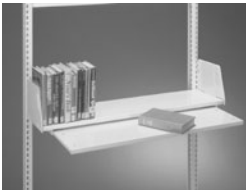

NOTE: Requires minimum 1" clear space underneath stationary shelf. Order Shelf separately. Must use narrow backstop.

## VHS, CD & PAPERBACK SHELF

Slotted on 1" centers. Includes one (1) Slotted Backstop and four (4) Dividers per shelf. Each shelf holds approximately 26 VHS tapes or 80 CDs.

| Actual Shelf Depth | Catalog No. |
|--------------------|-------------|
| 6"                 | CPV-3606    |



NOTE: When storing standard VHS tapes upright, recommend a minimum 10" vertical center-to-center spacing.

## 2 TIER, SLOPED VHS & CD SHELF

Each 36" wide shelf holds approximately 56 VHS tapes (28 per tier) or 168 CDs (84 per tier). Sloped to aid viewing.

| Overall Shelf Depth | Actual End Bracket Height | Catalog No. |
|---------------------|---------------------------|-------------|
| 14"                 | 11"                       | CVCD3615DT  |



NOTE: When storing standard VHS tapes on the second tier, recommend a minimum of 17" vertical center-to-center spacing. Also in 24" and 30" widths. Change the catalog no. accordingly, e.g.: CVCD2415DT. Use CDB-14 base support.

## VHS & CD WIRE RACK

One VHS & CD Wire Rack holds 26 VHS tapes or 78 CDs.

| Actual Shelf Depth | Catalog No. |
|--------------------|-------------|
| 6"                 | CVHSCD-R-36 |

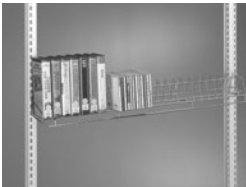

NOTE: When storing standard VHS tapes, recommend a minimum of 10" vertical center-to-center spacing.

## 2 TIER AUDIO CASSETTE TAPE SHELF

Each 36" wide shelf holds approximately 100 audio cassette tapes (50 per tier).

| Actual Shelf Depth | Overall Shelf Height | Catalog No.              |
|--------------------|----------------------|--------------------------|
| 6"                 | 7"                   | CATASB-3606 (Adjustable) |
| 6"                 | 10"                  | CATBSB-3606 (Base)       |



NOTE: Recommend a minimum 11" vertical center-to-center spacing. Also in 24" and 30" widths. Change the catalog no. accordingly, e.g., CATASB-3006.

## 2 TIER MICROFILM SHELF

Each 36" wide shelf holds approximately 40 ea. 13/4" w x 4" d x 4" h microfilm boxes (20 per tier).

| Actual Shelf Depth | Overall Shelf Height | Catalog No.            |
|--------------------|----------------------|------------------------|
| 9"                 | 7"                   | CMSS-3609 (Adjustable) |
| 9"                 | 10"                  | CMSSB-3609 (Base)      |



NOTE: Recommend a minimum 10" vertical center-to-center spacing.

## MULTIMEDIA BROWSING BOX

Each 36" wide unit stores approximately 56 VHS tapes or 120 CDs. Shown here accepting Snap-In Wire Dividers, catalog no. CHWS-67.

| Depth | Height | Catalog No. |
|-------|--------|-------------|
| 2"    | 6-1/4" | CBBM3612    |



NOTE: Includes black, non-skid floor mat. CHWS-67 "Snap-In" Wire Dividers sold separately. See page 9. When storing standard VHS tapes, recommend a minimum of 10" vertical center-to-center spacing. 24", 30" and 33.7" shelf widths are available.

## 1 TIER MULTIMEDIA BROWSING BOX (DIVIDER-TYPE)

Each 36" wide unit stores approximately 56 VHS tapes or 120 CDs.

| Depth | Height | Catalog No. |
|-------|--------|-------------|
| 12"   | 6-1/4" | CBB3612SMM  |



NOTE: Includes one black, non-skid floor mat. Dividers sold separately. See below for CMMD955 Dividers. When storing standard VHS tapes, recommend a minimum 10" vertical center-to-center spacing.

## 2 TIER MULTIMEDIA BROWSING BOX (DIVIDER-TYPE)

Each 36" wide unit stores approximately 64 VHS tapes or 132 CDs.

| Depth | Height | Catalog No.   |
|-------|--------|---------------|
| 15"   | 8-1/2" | CBB3615SMMMDT |

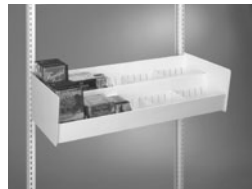

NOTE: Includes two black, non-skid floor mats. Dividers sold separately. See below for CMMD568 Dividers. When storing standard VHS tapes, recommend a minimum 12" vertical center-to-center spacing.

## MULTIMEDIA BROWSING BOX DIVIDERS

| For Browsing Box Type  | Catalog No. |
|------------------------|-------------|
| 1 TIER (CBB3612SMM)    | CMMD955     |
| 2 TIER (CBB3615SMMMDT) | CMMD568     |

| Media                | Quantity of Dividers Per Tier |
|----------------------|-------------------------------|
| CD'S                 | 5                             |
| VHS TAPES            | 7                             |
| MICROFILM BOXES      | 7                             |
| AUDIO CASSETTE TAPES | 11                            |

# ACCESSORIES

## ZIGZAG DISPLAY BACKSTOP

For merchandising a variety of audio-visual and paperback media.

| Height | Catalog No. |
|--------|-------------|
| 3-3/4" | CZBS-36     |

NOTE: Includes Backstop and fasteners only. Order Shelf separately.



## CENTERSTOP\* (Offset for back-to-back shelving)

Eliminates the need for individual backstops.

| Height | Catalog No. |
|--------|-------------|
| 3-3/4" | CCS-36      |

NOTE: Order Shelves separately.

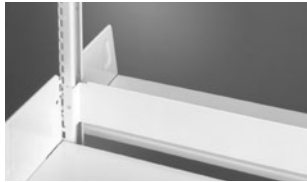

## PLAIN BACKSTOP\* (Narrow)

Order one (1) per shelf.

| Height | Catalog No. |
|--------|-------------|
| 3-3/4" | CABP36      |

NOTE: Order Shelves separately.



## SLOTTED BACKSTOP\* (Narrow)

Order one (1) per shelf..

| Height | Catalog No. |
|--------|-------------|
| 3-3/4" | CABS36      |

NOTE: Order Shelves separately.

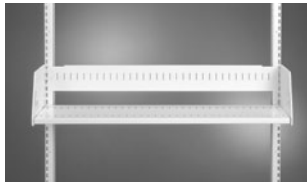

## PLAIN BACKSTOP\* (Full height)

Interlocks with shelf. Order one (1) per shelf.

| Height | Catalog No. |
|--------|-------------|
| 6"     | CPBS-36     |



## SLOTTED BACKSTOP\* (Full height)

Interlocks with shelf. Order one (1) per shelf.

| Height | Catalog No. |
|--------|-------------|
| 6"     | CSBS-36     |



## DIVIDERS

Dividers are all 6" high.

| Actual Shelf Depth | Catalog No. |
|--------------------|-------------|
| 6"                 | CFD-6       |
| 7"                 | CFD-7       |
| 8"                 | CFD-8       |
| 9"                 | CFD-9       |
| 10"                | CFD-10      |
| 11"                | CFD-11      |
| 12"                | CFD-12      |
| 15"                | CFD-15      |



## 6 TIER NEWSPAPER RACK

Display up to 6 newspapers.

| Catalog No. |
|-------------|
| CNR615      |

NOTE: For 36" newspaper sticks. Newspaper sticks not included. End bracket depth 12".

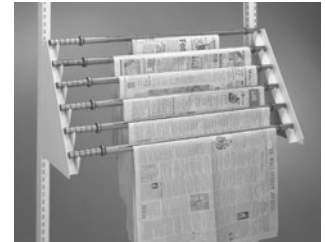

## MEDIA BAG RACK

Hang large or small media bags on this 36" rod. Includes deflection inhibiting low-back shelf, clip and end brackets.

| Will Accommodate Media Bags Up To | Actual End Bracket Depth | Shelf Depth | Catalog No. |
|-----------------------------------|--------------------------|-------------|-------------|
| 12" deep                          | 10"                      | 6"          | CMHR3610    |
| 20" deep                          | 12"                      | 10"         | CMHR3612    |

NOTE: Media bags not included.

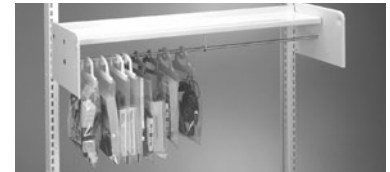

## STEEL BOOK SUPPORTS

### A. FINDABLE BOOK SUPPORT

Eliminates searching for book supports between books.

| Height | Pad Type         | Catalog No. |
|--------|------------------|-------------|
| 6"     | W/full cork base | CBE-06NL    |
| 9"     | W/full cork base | CBE-09NL    |
| 10"    | W/full cork base | CBE-10NL    |
| 6"     | W/magnetic base  | CBE-06NLM   |
| 9"     | W/magnetic base  | CBE-09NLM   |
| 10"    | W/magnetic base  | CBE-10NLM   |

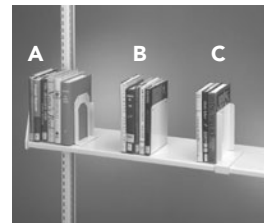

### B. FLAT BOOK END

Place media on top of the Flat Book End for support.

| Height | Catalog No. |
|--------|-------------|
| 4"     | CACD-4      |
| 6"     | CBE-06      |
| 9"     | CBE-09      |

NOTE: Includes full cork base.

### C. CLIP ON BOOK SUPPORT

Easy to locate the "Clip-On" Book Support since it clips on the shelf front.

| Height | Catalog No. |
|--------|-------------|
| 9"     | CCOD9       |

NOTE: Includes full cork base.



# ACCESSORIES (continued)

## "W" HANGING WIRE SUPPORT (Squeeze Type)

Available in three (3) sizes for five (5) different shelf depths.

| Actual Shelf Depth | Catalog No. |
|--------------------|-------------|
| 8" & 9"            | CWWS08      |
| 10" & 11"          | CWWS10      |
| 12"                | CWWS12      |
| 15"                | CWWS15      |

NOTE: If used with canopy tops, order the canopy tops specified for wire supports.

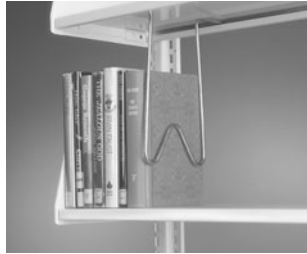

## "SNAP IN" HANGING WIRE BOOK SUPPORT

Hanging Wire Book Supports come in four (4) different sizes.

| Actual Shelf Depth | Catalog No. |
|--------------------|-------------|
| 6" & 7"            | CHWS-67*    |
| 8" & 9"            | CHWS-89     |
| 10", 11" & 12"     | CHWS-1012   |
| 15"                | CHWS-15     |

NOTE: \* CHWS-67 also works with Multimedia Browsing Box, catalog no. CBBM3612. CHWS-67 is "V" shape.



## INTEGRAL LOW-BACK DIVIDERS (For Integral Low-Back Shelves)

Available in three (3) sizes for five (5) different shelf depths.

| Actual Shelf Depth | Catalog No. |
|--------------------|-------------|
| 8" & 9"            | CLBD08      |
| 10", & 11"         | CLBD10      |
| 12"                | CLBD12      |

NOTE: Order Integral Low-Back Shelf separately.

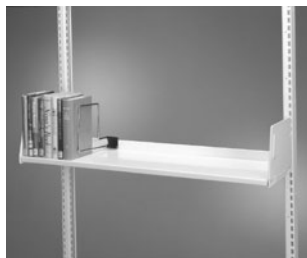

## RANGE FINDER & CARD HOLDERS

| Type                     | Size      | Catalog No. |
|--------------------------|-----------|-------------|
| A-Range Finder           | 3"H x 5"D | RFST35      |
| B-Continuous Card Holder | 4"H       | CSIHww*     |
| C-3x5 Card Holder        | 3"H x 5"D | CHST35      |

\*Where "ww" is the actual End Panel width, e.g. Use CSIH20 for a 20" wide End Panel.

NOTE: A & B available in the color to match the color of shelving ordered. C available in black finish. B & C include double-back tape.

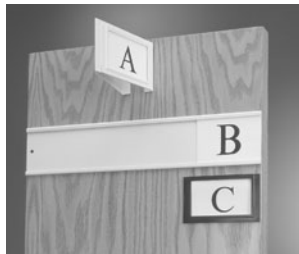

## SHELF LABEL HOLDERS

| Type            | Width | Catalog No. |
|-----------------|-------|-------------|
| A-Clear Plastic | 5"    | CLH-05      |
| B-Magnetic      | 36"   | LH-36       |

NOTE: Both A & B include paper label inserts.



\*24" and 30" widths available.

## CANOPY TOP\*

Includes mounting brackets.

| Overall Top Depth  | Actual Shelf Depth | Catalog No. |
|--------------------|--------------------|-------------|
| <b>SINGLE FACE</b> |                    |             |
| 8"                 | 6"                 | CCTSB-3606  |
| 9"                 | 7"                 | CCTSB-3607  |
| 10"                | 8"                 | CCTSB-3608  |
| 11"                | 9"                 | CCTSB-3609  |
| 12"                | 10"                | CCTSB-3610  |
| 13"                | 11"                | CCTSB-3611  |
| 14"                | 12"                | CCTSB-3612  |
| 15"                | 13"                | CCTSB-3613  |
| 17"                | 15"                | CCTSB-3615  |
| 20"                | 18"                | CCTSB-3618  |
| <b>DOUBLE FACE</b> |                    |             |
| 14"                | 6"                 | CCTDB-3606  |
| 16"                | 7"                 | CCTDB-3607  |
| 18"                | 8"                 | CCTDB-3608  |
| 20"                | 9"                 | CCTDB-3609  |
| 22"                | 10"                | CCTDB-3610  |
| 24"                | 11"                | CCTDB-3611  |
| 26"                | 12"                | CCTDB-3612  |
| 28"                | 13"                | CCTDB-3613  |
| 32"                | 15"                | CCTDB-3615  |
| 38"                | 18"                | CCTDB-3618  |



\*NOT A WEIGHT BEARING SHELF.

NOTE: Not compatible with "W" Hanging Wire Dividers. When "W" Hanging Wire Dividers are used, change "-" to "W" for a Canopy Top which will accommodate "W" Hanging Wire Dividers, e.g., CCTDBW3609.

## CANOPY LIGHT

Illuminate display shelves or brighten dimly lit alcoves. Includes white prismatic diffuser.

| Width | Depth   | Catalog No. |
|-------|---------|-------------|
| 36"   | 20-1/2" | CCLIGHT3621 |

NOTE: Internal, UL listed 24" light fixture accepts 2-24" long bulbs. Bulbs not included. Light housing is 12-3/8" deep and 5" high. 36" frame width only.



## BRACKETS FOR LAMINATED CANOPY TOP

Fasteners included.

| Actual Overall Top Depth | Left End Catalog No. | Right End Catalog No. |
|--------------------------|----------------------|-----------------------|
| 6", 7" & 8"              | CCTBL-6L             | CCTBL-6R              |
| 9", 10", 11", 12", & 15" | CCTBL-15L            | CCTBL-15R             |

NOTE: Order left and right brackets separately. In the photo, one CCTBL-15L and one CCTBL-15R are shown in conjunction with a 20" deep (overall) laminated canopy top which was designed to accommodate actual 9" deep shelves.



## BASE SHELF FILLER\*

Fills the space between the two back-to-back Base Shelves.

| Shelf Depth                          | Catalog No. |
|--------------------------------------|-------------|
| 36"<br>(For use with 3" Base Shelf.) | CBSF-36     |
| 36"<br>(For use with 1" Base Shelf.) | CBSF1-36    |



# ACCESSORIES (continued)

## ADJUSTABLE SHELF FILLER\*

Fills the space between two back-to-back Adjustable Shelves.

| Shelf Width | Catalog No. |
|-------------|-------------|
| 36"         | CASF36      |

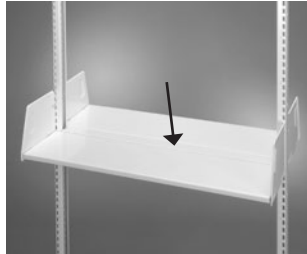

## ADJUSTABLE KICK PLATES\*

Adjustable Kick Plates may be used when Adjustable Shelves are used as Base Shelves.

| Kick Plate Type   | Catalog No. |
|-------------------|-------------|
| RECESSED**        | CKP36       |
| FLUSH (Not Shown) | CFKP36      |

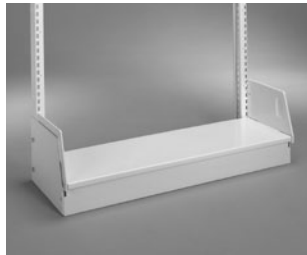

NOTE: Adjustable, Flush Kick Plate not shown.

\*\* Base supports must be 1" less than shelf depth when using Adjustable Recessed Kick Plate.

Both types include mounting hardware.

Both may be used with or without levelers.

Requires an additional 1" of frame height when used with no leveler kits.

## LEVELER KITS

Use when floor is out of level.

| No. Of Leveling Feet Per Kit | Actual Base Support Depths | Catalog No. |
|------------------------------|----------------------------|-------------|
| SINGLE FACE                  |                            |             |
| 3                            | 8", 9" & 10"               | CSFL0608    |
| 4                            | 11", 12", 13", 14", & 17"  | CSFL0915    |
| DOUBLE FACE                  |                            |             |
| 4                            | 14", 16" & 18"             | CDFL0608    |
| 6                            | 20", 22", 24", 26" & 32"   | CDFL0915    |

NOTE: Order one (1) kit per base support .



## WALL ATTACHMENT BRACKET

For attaching single face Welded Frames to a wall.

| Catalog No. |
|-------------|
| CWAB        |

NOTE: Fastening hardware not included since wall material may vary.



# OPTIONS (continued)

## END PANEL MOUNTING BRACKETS

For use on both Metal End Panels and Laminate End Panels when Canopy Top is not used. Double face bracket shown.

### SINGLE FACE

| Actual Shelf Depth | Catalog No. |
|--------------------|-------------|
| 6"                 | CMEPSS08L   |
| 6"                 | CMEPSS08R   |
| 7"                 | CMEPSS09L   |
| 7"                 | CMEPSS09R   |
| 8"                 | CMEPSS10L   |
| 8"                 | CMEPSS10R   |
| 9"                 | CMEPSS11L   |
| 9"                 | CMEPSS11R   |
| 10"                | CMEPSS12L   |
| 10"                | CMEPSS12R   |
| 11"                | CMEPSS13L   |
| 11"                | CMEPSS13R   |
| 12"                | CMEPSS14L   |
| 12"                | CMEPSS14R   |
| 13"                | CMEPSS15L   |
| 13"                | CMEPSS15R   |
| 15"                | CMEPSS17L   |
| 15"                | CMEPSS17R   |
| 16"                | CMEPSS18L   |
| 16"                | CMEPSS18R   |

### DOUBLE FACE

| Actual Shelf Depth | Catalog No. |
|--------------------|-------------|
| 6"                 | CMEPSD14    |
| 7"                 | CMEPSD16    |
| 8"                 | CMEPSD18    |
| 9"                 | CMEPSD20    |
| 10"                | CMEPSD22    |
| 11"                | CMEPSD24    |
| 12"                | CMEPSD26    |
| 13"                | CMEPSD28    |
| 15"                | CMEPSD32    |
| 18"                | CMEPSD38    |

NOTE: Order one (1) per End Panel.



# OPTIONS (continued)

## CLOSURE PANELS

May be used to enclose backside of the End Panels. Match the End Panel size.

### SINGLE FACE

| End Panel Width         | Catalog No. |
|-------------------------|-------------|
| <b>78" FRAME HEIGHT</b> |             |
| 8"                      | CCP-0878    |
| 9"                      | CCP-0978    |
| 10"                     | CCP-1078    |
| 11"                     | CCP-1178    |
| 12"                     | CCP-1278    |
| 13"                     | CCP-1378    |
| 14"                     | CCP-1478S   |
| 17"                     | CCP-1778    |
| <b>84" FRAME HEIGHT</b> |             |
| 8"                      | CCP-0884    |
| 9"                      | CCP-0984    |
| 10"                     | CCP-1084    |
| 11"                     | CCP-1184    |
| 12"                     | CCP-1284    |
| 13"                     | CCP-1384    |
| 14"                     | CCP-1484S   |
| 17"                     | CCP-1784 8  |
| <b>90" FRAME HEIGHT</b> |             |
| 8"                      | CCP-0890    |
| 9"                      | CCP-0990    |
| 10"                     | CCP-1090    |
| 11"                     | CCP-1190    |
| 12"                     | CCP-1290    |
| 13"                     | CCP-1390    |
| 14"                     | CCP-1490S   |
| 17"                     | CCP-1790    |

### DOUBLE FACE

| End Panel Width         | Catalog No. |
|-------------------------|-------------|
| <b>78" FRAME HEIGHT</b> |             |
| 14"                     | CCP-1478D   |
| 16"                     | CCP-1678    |
| 18"                     | CCP-1878    |
| 20"                     | CCP-2078    |
| 22"                     | CCP-2278    |
| 24"                     | CCP-2478    |
| 26"                     | CCP-2678    |
| 32"                     | CCP-3278    |
| <b>84" FRAME HEIGHT</b> |             |
| 14"                     | CCP-1484D   |
| 16"                     | CCP-1684    |
| 18"                     | CCP-1884    |
| 20"                     | CCP-2084    |
| 22"                     | CCP-2284    |
| 24"                     | CCP-2484    |
| 26"                     | CCP-2684    |
| 32"                     | CCP-3284    |
| <b>90" FRAME HEIGHT</b> |             |
| 14"                     | CCP-1490D   |
| 16"                     | CCP-1690    |
| 18"                     | CCP-1890    |
| 20"                     | CCP-2090    |
| 22"                     | CCP-2290    |
| 24"                     | CCP-2490    |
| 26"                     | CCP-2690    |
| 32"                     | CCP-3290    |

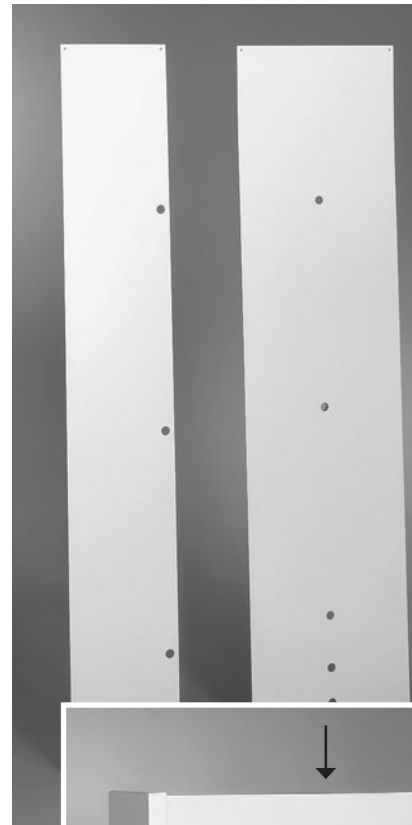

NOTE: Also available in 24" and 30" widths. Change the catalog no. accordingly, e.g.: CBPF-4224.

## CLOSED BACK KITS

Fills the space between the upright frame. Kits include two (2) Upright Fillers (hidden from view).

| Frame Height | Catalog No. | Frame Height | Catalog No. |
|--------------|-------------|--------------|-------------|
| 42"          | CBPF-4236   | 84"          | CBPF-8436   |
| 66"          | CBPF-6636   | 90"          | CBPF-9036   |
| 78"          | CBPF-7836   |              |             |

## INTERMEDIATE WALL FILLERS

Fills the rectangular void created when two single face sections are placed at a right angle with a double face section. Specify overall unit depths (ds & dd) and frame height used (ht).

Catalog No.  
CIF-dsdddsh

NOTE: ds = overall depth of the single face unit in inches (including the 2" frame) dd = overall depth of the double face unit in inches (including the 2" frame) ht = height of the adjoining Welded Frame, e.g., CIF-11201184 (for shelves with an actual depth of 9").



## CORNER FILLERS

Fills the corner void created when single face sections are placed at right angles. Specify overall unit depths (dsds) and frame height used (ht).

Catalog No.  
CCF-dsdsht

NOTE: ds = overall depth of the single face unit in inches (including the 2" frame) ht = height of the adjoining Welded Frame, e.g., CCF-111184 (for shelves with an actual depth of 9").



# OPTIONS (continued)

## METAL END PANELS

Use to finish off the exposed ends of shelving ranges.  
Metal End Panels are 1-1/2" thick .

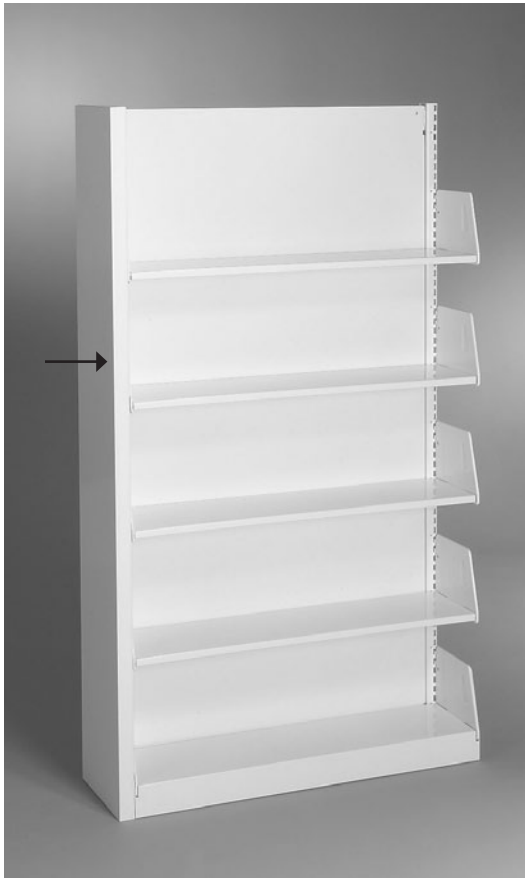

NOTE: End Panels should be sized to cover the overall base depth.  
(overall base shelf depth = actual shelf depth + 2" frame.)  
End Panel Mounting Brackets sold separately. See page 12.

## SINGLE FACE

| Actual Shelf Depth        | Catalog No. |
|---------------------------|-------------|
| <b>42" UPRIGHT HEIGHT</b> |             |
| 6"                        | CRMEP4208   |
| 7"                        | CRMEP4209   |
| 8"                        | CRMEP4210   |
| 9"                        | CRMEP4211   |
| 10"                       | CRMEP4212   |
| 11"                       | CRMEP4213   |
| 12"                       | CRMEP4214   |
| 13"                       | CRMEP4215   |
| 15"                       | CRMEP4217   |
| <b>66" UPRIGHT HEIGHT</b> |             |
| 6"                        | CRMEP6608   |
| 7"                        | CRMEP6609   |
| 8"                        | CRMEP6610   |
| 9"                        | CRMEP6611   |
| 10"                       | CRMEP6612   |
| 11"                       | CRMEP6613   |
| 12"                       | CRMEP6614   |
| 13"                       | CRMEP6615   |
| 15"                       | CRMEP6617   |
| <b>78" UPRIGHT HEIGHT</b> |             |
| 6"                        | CRMEP7808   |
| 7"                        | CRMEP7809   |
| 8"                        | CRMEP7810   |
| 9"                        | CRMEP7811   |
| 10"                       | CRMEP7812   |
| 11"                       | CRMEP7813   |
| 12"                       | CRMEP7814   |
| 13"                       | CRMEP7815   |
| 15"                       | CRMEP7817   |
| <b>84" UPRIGHT HEIGHT</b> |             |
| 6"                        | CRMEP8408   |
| 7"                        | CRMEP8409   |
| 8"                        | CRMEP8410   |
| 9"                        | CRMEP8411   |
| 10"                       | CRMEP8412   |
| 11"                       | CRMEP8413   |
| 12"                       | CRMEP8414   |
| 13"                       | CRMEP8415   |
| 15"                       | CRMEP8417   |
| <b>90" UPRIGHT HEIGHT</b> |             |
| 6"                        | CRMEP9008   |
| 7"                        | CRMEP9009   |
| 8"                        | CRMEP9010   |
| 9"                        | CRMEP9011   |
| 10"                       | CRMEP9012   |
| 11"                       | CRMEP9013   |
| 12"                       | CRMEP9014   |
| 13"                       | CRMEP9015   |
| 15"                       | CRMEP9017   |

## DOUBLE FACE

| Actual Shelf Depth        | Catalog No. |
|---------------------------|-------------|
| <b>42" UPRIGHT HEIGHT</b> |             |
| 6"                        | CRMEP4214D  |
| 7"                        | CRMEP4216D  |
| 8"                        | CRMEP4218D  |
| 9"                        | CRMEP4220D  |
| 10"                       | CRMEP4222D  |
| 11"                       | CRMEP4224D  |
| 12"                       | CRMEP4226D  |
| 13"                       | CRMEP4228D  |
| 15"                       | CRMEP4232D  |
| <b>66" UPRIGHT HEIGHT</b> |             |
| 6"                        | CRMEP6614D  |
| 7"                        | CRMEP6616D  |
| 8"                        | CRMEP6618D  |
| 9"                        | CRMEP6620D  |
| 10"                       | CRMEP6622D  |
| 11"                       | CRMEP6624D  |
| 12"                       | CRMEP6626D  |
| 13"                       | CRMEP6628D  |
| 15"                       | CRMEP6632D  |
| <b>78" UPRIGHT HEIGHT</b> |             |
| 6"                        | CRMEP7814D  |
| 7"                        | CRMEP7816D  |
| 8"                        | CRMEP7818D  |
| 9"                        | CRMEP7820D  |
| 10"                       | CRMEP7822D  |
| 11"                       | CRMEP7824D  |
| 12"                       | CRMEP7826D  |
| 13"                       | CRMEP7828D  |
| 15"                       | CRMEP7832D  |
| <b>84" UPRIGHT HEIGHT</b> |             |
| 6"                        | CRMEP8414D  |
| 7"                        | CRMEP8416D  |
| 8"                        | CRMEP8418D  |
| 9"                        | CRMEP8420D  |
| 10"                       | CRMEP8422D  |
| 11"                       | CRMEP8424D  |
| 12"                       | CRMEP8426D  |
| 13"                       | CRMEP8428D  |
| 15"                       | CRMEP8432D  |
| <b>90" UPRIGHT HEIGHT</b> |             |
| 6"                        | CRMEP9014D  |
| 7"                        | CRMEP9016D  |
| 8"                        | CRMEP9018D  |
| 9"                        | CRMEP9020D  |
| 10"                       | CRMEP9022D  |
| 11"                       | CRMEP9024D  |
| 12"                       | CRMEP9026D  |
| 13"                       | CRMEP9028D  |
| 15"                       | CRMEP9032D  |



Spacesaver Corporation  
1450 Janesville Avenue  
Fort Atkinson, WI 53538-2798  
1-800-492-3434  
www.spacesaver.com

Spacesaver Corporation is a division of KI.

KI is a registered trademark of Krueger International, Inc.

Spacesaver is a registered trademark of Spacesaver Corporation.

© 2012 KI and Spacesaver Corporation. All Rights Reserved. Litho in USA. LIBSHELVING\_0712\_broch (SC-0241)



KI  
1330 Bellevue Street  
P.O. Box 8100  
Green Bay, WI 54302-8100  
1-800-424-2432  
www.ki.com